

DISTRIBUTION

Molded Case Circuit Breakers

BX Series



Safety and performance

Compactness, discrimination and modularity – new circuit breakers incorporate advanced monitoring and communication functions, from 40 amps up, combined with impeccable protection.

Expert technology

A roto-active contact breaking principle provides each circuit breaker with very high breaking capacity in a very small device, remarkable fault current limitation performance, and endurance.

- BX benefits from a patented double roto-active contact breaking concept, together with a reflex tripping system for ultimate breaking.
- Exceptional fault current limitation guarantees robust, reliable protection and, above all, reduces the causes of component aging, thus extending service life for installations.



Breaking performance at 415V 50/60Hz

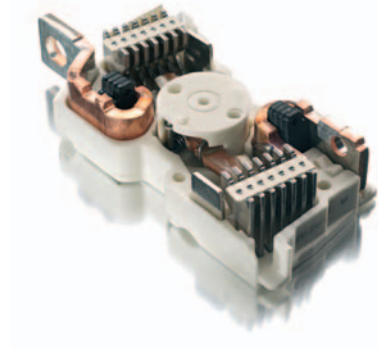
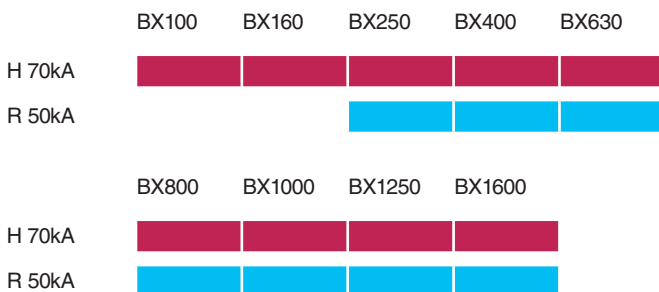

New breaking capacities

New performance levels for BX improve application targeting:

- 50 kA – standard applications (industrial plants, buildings and hospitals),
- 70 kA – high performance at controlled cost.

Reduced installation costs

Optimising installations allows for achieving up to 30 % savings:

- considerable savings at the time of installation, thanks to total discrimination with miniature circuit breakers,
- smaller devices, more economic switchboards mean best overall installation cost, without overcalibration.



Monitoring and management

BX is a single device, which contains a monitoring unit to control energy consumption and power.

Integrated monitoring

- The BX range incorporates electronic trip units in the circuit breaker, offering both:
 - an accurate power monitoring unit,
 - a highly reliable protective device.
- An electronic tripping device combines next-generation sensors:
 - an "iron" sensor for the power supply to the electronics,
 - an "air" sensor (Rogowski coils) for measurement, guaranteeing high accuracy.
- These electronic systems are designed to withstand high temperatures (105°C), ensuring reliability under severe operating conditions.
- The originality lies in how measures, processes and displays data, either directly on screen, on the switchboard front panel, or via a monitoring system.

Accessibility of information...

To keep costs under control and ensure service continuity, relevant information must be available in real time:

- a kilowatt-hour meter helps optimise costs and their allocation,
- harmonic distortion rate shows the quality of electrical supply,
- alarm notification secures operational control and maintenance planning,
- event logs and tables, activated continuously, ensure the installed equipment base operates correctly, so energy efficiency is maximized.

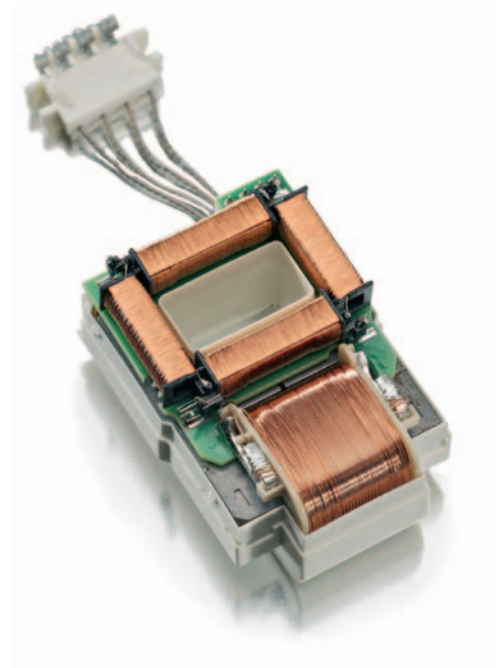

Simplicity

BX takes the principles of easy installation and use – which made its predecessor so successful – to a higher level.

Simple in design

Cut-outs are the same whatever the type of handle. Engineering drawings are the same, so installation and connection layouts can be used on new projects, simplifying extensions or retrofits, and reducing maintenance costs.

Integration in help software, for parameter settings and switchboard installation, further eases design.

Simple to install

- A Limited Torque Screw (LTS) system ensures proper installation of the tripping device, for added flexibility. It insures each screw is aligned correctly and tightened to the required torque. The LTS system thus avoids the need for a torque wrench.
- A transparent lead-sealable cover protects access to tripping device switches and prevents settings from being changed.
- The new electrical control adjustment also has a transparent lead- sealable cover to prevent it from being operated accidentally.
- BX has an optional functional terminal shield that offers excellent protection against direct contact (IP40 on all sides, IP20 at cable entry points) and easy installation.
- All BX devices can be equipped with a communication function via a pre-wired connection with a Modbus interface module. When the Modbus address is declared, the BX device is integrated into the network.
- There are four levels of functionalities:
 - communication of device status: On/Off position, trip indication and fault-trip indication,
 - communication of commands: open, close, and reset,
 - communication of measurements: mainly I, U, f, P, E, and THD,
 - communication of operating assistance data: settings, parameters, alarms, histograms and event tables, and maintenance indicators.
- The switchboard "plug & play" display unit connects to the trip unit without any special settings or configuration. A cable fitted with an RJ45 connector allows for easy integration with communications networking.

Simple to use

- Users customise time-stamped alarms for all parameters, assign them to indicator lights, choose display priorities, and configure time delay thresholds and modes.
- Event logs and tables are continuously-activated. Providing a wealth of information, they enable users to ensure that the installed equipment base operates correctly, to optimize settings, and to maximise energy efficiency.
- Local and remote displays offer easy access to operators and provide the main electrical values: I, U, V, f, energy, power, total harmonic distortion, etc. The user-friendly switchboard display unit with intuitive navigation is more comfortable to read, and offers quick access to information.

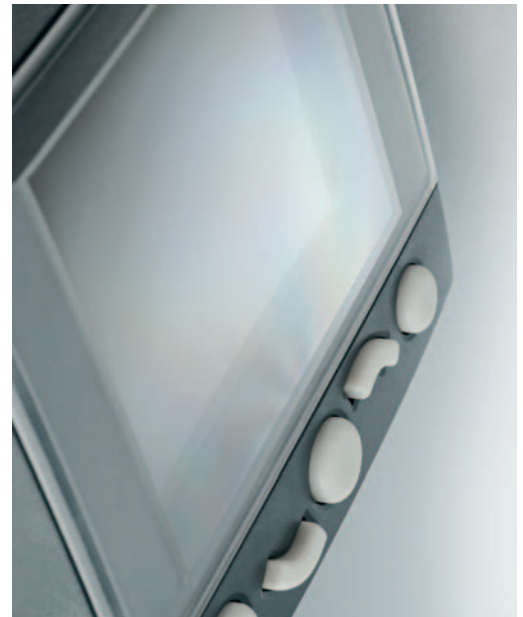
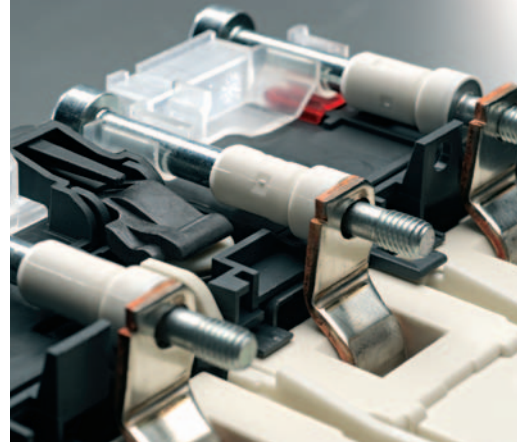

Performance, yet unimposing. BX perfectly blends into its environment.

Quick View	
Iavg	120 A
Uavg	102 V
Ptot	144 kW
Ep	14370 kWh
Esc	

Attractively designed.

The front of BX circuit breakers has an attractive curved profile.

Measurements are easy to read on a backlit LCD display. Screen navigation is intuitive and settings are simplified by immediate readouts in amps.

Introduction

General characteristics of the BX range

Compliance with standards

BX circuit breakers and auxiliaries comply with the following:

- international recommendations:
- IEC 60947-1: general rules
- IEC 60947-2: circuit breakers
- IEC 60947-3: switch-disconnectors
- IEC 60947-4: contactors and motor starters
- IEC 60947-5.1 and following: control circuit devices and switching elements; automatic control components

Pollution degree

BX circuit breakers are certified for operation in pollution-degree 3 environments as defined by IEC standards 60947-1 and 60664-1 (industrial environments).

Climatic withstand

BX circuit breakers have successfully passed the tests defined by the following standards for extreme atmospheric conditions:

- IEC 60068-2-1: dry cold (-55 °C)
- IEC 60068-2-2: dry heat (+85 °C)
- IEC 60068-2-30: damp heat (95 % relative humidity at 55 °C)
- IEC 60068-2-52 severity level 2: salt mist.

Environment

BX respects the European environment directive EC/2002/95 concerning the restriction of hazardous substances (RoHS).

Product environment profiles (PEP) have been prepared, describing the environmental impact of every product throughout its life cycle, from production to the end of its service life.

All BX production sites have set up an environmental management system certified ISO 14001.

Each factory monitors the impact of its production processes. Every effort is made to prevent pollution and to reduce consumption of natural resources.

Ambient temperature

- BX circuit breakers may be used between -25 °C and +70 °C. For temperatures higher than 40 °C (65 °C for circuit breakers used to protect motor feeders), devices must be derated (page 62 and page 63).
- Circuit breakers should be put into service under normal ambient, operating-temperature conditions. Exceptionally, the circuit breaker may be put into service when the ambient temperature is between -35 °C and -25 °C.
- The permissible storage-temperature range for BX circuit breakers in the original packing is -50 °C (1) and +85 °C.
(1) -40 °C for control units with an LCD screen.

Functions and characteristics

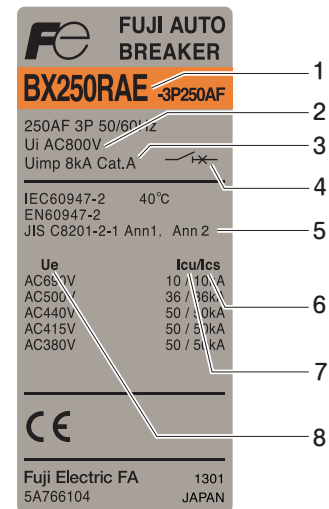

Standardised characteristics indicated on the rating plate:

- 1 Type of device: frame size and breaking capacity class
- 2 Ui: rated insulation voltage.
- 3 Uimp: rated impulse withstand voltage.
- 4 Circuit breaker-disconnector symbol.
- 5 Reference standard.
- 6 Ics: service breaking capacity.
- 7 Icu: ultimate breaking capacity for various values of the rated operational voltage Ue
- 8 Ue: operational voltage.

Note: when the circuit breaker is equipped with an extended rotary handle, the door must be opened to access the rating plate.

Introduction

Electromagnetic compatibility

BX devices are protected against:

- overvoltages caused by circuit switching (e.g. lighting circuits)
- overvoltages caused by atmospheric disturbances
- devices emitting radio waves such as mobile telephones, radios, walkie-talkies, radar, etc.
- electrostatic discharges produced by users.

Immunity levels for BX comply with the standards below.

- IEC/EN 60947-2: Low-voltage switchgear and controlgear, part 2: Circuit breakers:
 - Annex F: Immunity tests for circuit breakers with electronic protection
 - Annex B: Immunity tests for residual current protection
- IEC/EN 61000-4-2: Electrostatic-discharge immunity tests
- IEC/EN 61000-4-3: Radiated, radio-frequency, electromagnetic-field immunity tests
- IEC/EN 61000-4-4: Electrical fast transient/burst immunity tests
- IEC/EN 61000-4-5: Surge immunity tests
- IEC/EN 61000-4-6: Immunity tests for conducted disturbances induced by radio-frequency fields
- CISPR 11: Limits and methods of measurement of electromagnetic disturbance characteristics of industrial, scientific and medical (ISM) radio-frequency equipment.

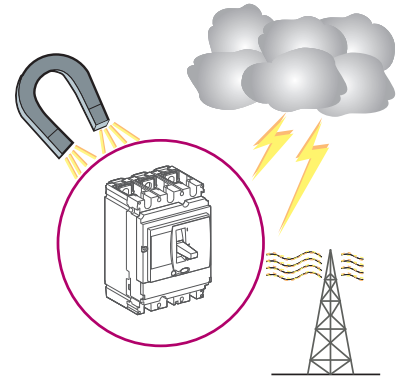

Discrimination

Bx reinforces the discrimination capabilities of the conventional breaker range by applying the rapid calculation capacity of the Control units.

Total discrimination is now possible between BX100 and BC series miniature circuit breakers rated ≤ 63 A (see page 12).

Suitable for isolation with positive contact indication

All BX circuit breakers are suitable for isolation as defined in IEC standard 60947-2:

- The isolation position corresponds to the O (OFF) position.
- The operating handle cannot indicate the OFF position unless the contacts are effectively open.
- Padlocks may not be installed unless the contacts are open.

Installation of a rotary handle or a motor mechanism does not alter the reliability of the position-indication system.

The isolation function is certified by tests guaranteeing:

- the mechanical reliability of the position-indication system
- the absence of leakage currents
- overvoltage withstand capacity between upstream and downstream connections.

The tripped position does not insure isolation with positive contact indication.

Only the OFF position guarantees isolation.



Installation in class II switchboards

All BX circuit breakers are class II front face devices. They may be installed through the door of class II switchboards (as per IEC standards 61140 and 60664-1) without downgrading switchboard insulation.

Installation requires no special operations, even when the circuit breaker is equipped with a rotary handle or a motor mechanism.

Degree of protection

The following indications are in accordance with standards IEC 60529 (IP degree of protection) and IEC 62262 (IK protection against external mechanical impacts).

Bare circuit breaker with terminal shields				
	With toggle		IP40	IK07
	With standard direct rotary handle / VDE		IP40	IK07
Circuit breaker installed in a switchboard				
	With toggle		IP40	IK07
	With direct rotary handle	standard / VDE	IP40	IK07
	With extended rotary handle		IP55	IK08
	With motor mechanism		IP40	IK07

Catalog Disclaimer

The information contained in this catalog does not constitute an express or implied warranty of quality, any warranty of merchantability of fitness for a particular purpose is hereby disclaimed.

Since the user's product information, specific use application, and conditions of use are all outside of Fuji Electric FA Components & Systems' control, **it shall be the responsibility of the user to determine the suitability of any of the products mentioned for the user's application.**

One Year Limited Warranty

The products identified in this catalog shall be sold pursuant to the terms and conditions identified in the "Conditions of Sale" issued by Fuji Electric FA with each order confirmation.

Except to the extent otherwise provided for in the Conditions of Sale issued by Fuji Electric FA, Fuji Electric FA warrants that the Fuji Electric FA products identified in this catalog shall be free from significant defects in materials and workmanship provided the product has not been: 1) repaired or altered by others than Fuji Electric FA; 2) subjected to negligence, accident, misuse, or damage by circumstances beyond Fuji Electric FA's control; 3) improperly operated, maintained or stored; or 4) used in other than normal use or service. This warranty shall apply only to defects appearing within one (1) year from the date of shipment by Fuji Electric FA, and in such case, only if such defects are reported to Fuji Electric FA within thirty (30) days of discovery by purchaser. Such notice should be submitted in writing to Fuji Electric FA at 5-7, Nihonbashi Odemma-cho, Chuo-ku, Tokyo, Japan. The sole and exclusive remedy with respect to the above warranty whether such claim is based on warranty, contract, negligence, strict liability or any other theory, is limited to the repair or replacement of such product or, at Fuji Electric FA's option reimbursement by Fuji Electric FA of the purchase price paid to Fuji Electric FA for the particular product. **Fuji Electric FA does not make any other representations or warranties, whether oral or in writing, expressed or implied, including but not limited to any warranty regarding merchantability or fitness for a particular purpose.** Except as provided in the Conditions of Sale, no agent or representative of Fuji Electric FA is authorized to modify the terms of this warranty in writing or orally.

In no event shall Fuji Electric FA be liable for special, indirect or consequential damages, including but not limited to, loss of use of the product, other equipment, plant and power system which is installed with the product, loss of profits or revenues, cost of capital, or claims against the purchaser or user of the product by its customers resulting from the use of information, recommendations and descriptions contained herein. The purchaser agrees to pass on to its customers and users, in writing at the time inquiries and orders are received by buyer, Fuji Electric FA's warranty as set forth above.

Safety Considerations

- Operate (keep) in the environment specified in the operating instructions and manual. High temperature, high humidity, condensation, dust, corrosive gases, oil, organic solvents, excessive vibration or shock might cause electric shock, fire, erratic operation or failure.
- For safe operation, before using the product read the instruction manual or user manual that comes with the product carefully or consult the Fuji sales representative from which you purchased the product.
- Products introduced in this catalog have not been designed or manufactured for such applications in a system or equipment that will affect human bodies or lives.
- Customers, who want to use the products introduced in this catalog for special systems or devices such as for atomic-energy control, aerospace use, medical use, passenger vehicle, and traffic control, are requested to consult with Fuji Electric FA.
- Customers are requested to prepare safety measures when they apply the products introduced in this catalog to such systems or facilities that will affect human lives or cause severe damage to property if the products become faulty.
- For safe operation, wiring should be conducted only by qualified engineers who have sufficient technical knowledge about electrical work or wiring.
- Follow the regulations of industrial wastes when the product is to be discarded.
- For further questions, please contact your Fuji sales representative or Fuji Electric FA.

Molded Case Circuit Breakers BX Series

	Page
100AF to 630AF	
Functions and characteristics	
Characteristics and performance of BX circuit breakers from 100 to 630 A.....	11
BX trip units.....	12
Overview of trip units for BX.....	14
Protection of distribution systems	
TM-D thermal-magnetic trip units.....	18
Control unit 2.....	20
Control units 5/6A or E.....	22
Power Meter functions	
Control units 5 / 6 A or E.....	24
Operating-assistance functions	
Control units 5 / 6 A or E.....	26
Communication	
Communications modules.....	28
Networks.....	30
Accessories and auxiliaries	
Overview of BX100 to 630 fixed version.....	32
Overview of BX100 to 630 plug-in version.....	33
Device installation.....	34
Connection of fixed devices.....	35
Connection of plug-in devices.....	37
Insulation of live parts.....	38
Selection of auxiliaries for BX100/160/250.....	39
Selection of auxiliaries for BX400/630.....	41
Indication contacts.....	43
SDx modules for Control unit.....	43
Motor mechanism.....	44
Remote tripping.....	45
Rotary handles.....	46
Operating conditions	
Operating conditions.....	48
Installation in switchboards	
Power supply and mass.....	49
Safety clearances and minimum distances.....	50
Installation example.....	51
Temperature derating	
BX100 to 250 equipped with thermal-magnetic trip units....	54
BX equipped with electronic trip units.....	55
Power loss/ Resistance	
BX100 to 250 equipped with thermal-magnetic trip units....	56
BX equipped with electronic trip units.....	56
Dimensions and mounting	
BX100 to 630 fixed version.....	57
BX100 to 630 plug-in version.....	58
Motor mechanism module for BX100 to 630.....	60
Direct rotary handle for BX100 to 630.....	61
Extended rotary handle for BX100 to 630.....	62

	Page
Power connections	
BX100 to 630 fixed version.....	63
BX100 to 630 plug-in versions.....	65
Connection of insulated bars or cables with lugs to BX100 to 630.....	67
Wiring diagrams	
BX100 to 630 Fixed circuit breakers.....	68
BX100 to 630 Plug-in circuit breakers.....	70
BX100 to 630 Motor mechanism.....	72
BX100 to 630 SDx module with Control unit.....	74
Tripping curves	
BX100 to 250 Protection of distribution systems.....	76
BX400 to 630 Protection of distribution systems.....	80
BX100 to 630 Reflex tripping.....	82
Current and energy limiting curves.....	83

	Page
800AF to 1600AF	
Protection of distribution systems	
BX circuit breakers from 800 to 1600 A.....	86
Control units	
Overview of functions.....	88
For BX800 to 1600.....	90
A "ammeter".....	92
E "energy".....	94
P "power".....	96
Power Meter functions	
A/E/P control unit with COM option (BCM ULP).....	100
Operating-assistance functions	
A/E/P control unit with COM option (BCM ULP).....	102
Protection of distribution systems	
Control units for BX800 to 1600.....	104
Portable data acquisition.....	105
Communication	
BX800 to 1600 COM option.....	106
Overview of functions.....	107
Networks.....	108
Electrical and mechanical accessories	
BX800 to 1600 (fixed version).....	109
BX800 to 1600.....	110
Connections accessories.....	112
Front connection of fixed devices.....	113
Rear connection of fixed devices.....	114
Interphase barriers.....	116
Connection of electrical auxiliaries.....	116
Indication contacts.....	117
Rotary handles.....	117

	Page
Operating conditions	120
Installation in switchboards	
Power supply and mass	121
Safety clearances and minimum distances	122
Installation example.....	123
Control wiring	124
Temperature derating	
BX devices equipped with electronic trip units	125
Power dissipation / Resistance	
BX devices equipped with electronic trip units	126
Dimensions and mounting	
BX800 to 1600 (fixed version)	
Dimensions	127
Mounting	128
Front-panel cutouts	129
Rotary handle.....	130
Accessories BX800 to 1600	132
Power connections	
BX800 to 1600 (fixed version)	
Bars.....	133
Electrical diagrams	
BX800 to 1600 Fixed circuit breakers	136
BX800 to 1600 Plug-in circuit breakers.....	138
BX800 to 1600 Earth-fault and earth-leakage protection..	140
BX800 to 1600 Communication.....	142
BX800 to 1600 fixed Wiring of the COM option (Modbus BCM ULP Module) with or without ULP module	144
Tripping curves	
BX800 to 1600	146
Current-limiting curves	148
Ordering information	149

Molded Case Circuit Breakers BX series (100AF to 630AF) Functions and characteristics

■ Characteristics and performance of BX circuit breakers from 100 to 630 A

• Common characteristics

Rated voltages	Insulation voltage (V)	Ui	800
	Impulse withstand voltage (kV)	Uimp	8
	Operational voltage (V)	Ue	AC 50/60Hz 690
Suitability for isolation	IEC/EN 60947-2		yes
Utilisation category			A
Pollution degree	IEC 60664-1		3
Control	Manual With toggle		●
	With direct or extended rotary handle		●
	Electrical With remote control		●
Versions	Fixed		●
	Withdrawable Plug-in base		●

• Circuit breakers

Type			BX100	BX160	BX250		BX400		BX630		
Breaking capacity levels			H	H	R	H	R	H	R	H	
Electrical characteristics as per IEC 60947-2											
Rated current (A)	In	40°C	100	160	250		400		630		
Number of poles			3, 4	3, 4	3, 4		3, 4		3, 4		
Breaking capacity (kA rms)	Icu	AC 50/60Hz	220/240V	100	100	90	100	85	100	85	100
			380/415V	70	70	50	70	50	70	50	70
			440V	65	65	50	65	42	65	42	65
			500V	50	50	36	50	30	50	30	50
			525V	35	35	35	35	22	35	22	35
			660/690V	10	10	10	10	10	20	10	20
Service breaking capacity (kA rms)	Ics	AC 50/60Hz	220/240V	100	100	90	100	85	100	85	100
			380/415V	70	70	50	70	50	70	50	70
			440V	65	65	50	65	42	65	42	65
			500V	50	50	36	50	30	50	30	50
			525V	35	35	35	35	11	11	11	11
			660/690V	10	10	10	10	10	10	10	10
Durability (C-O cycles)	Mechanical			50000	40000	20000		15000		15000	
		Electrical	440V In/2	50000	40000	20000		12000		8000	
			In	30000	20000	10000		6000		4000	
			690V In/2	20000	15000	10000		6000		6000	
		In	10000	7500	5000		3000		2000		
Characteristics as per Nema AB1	Breaking capacity (kA rms)	AC 50/60Hz	240V	100	100	90	100	85	100	85	100
			480V	65	65	50	65	42	65	42	65
			600V	35	35	20	35	20	35	20	35
Characteristics as per UL 508	Breaking capacity (kA rms)	AC 50/60Hz	240V	85	85	85	85	85	85	85	85
			480V	65	65	50	65	50	65	50	65
			600V	10	10	15	15	20	20	20	20
Protection and measurements											
Short-circuit protection	Magnetic only		●	●	●	●	●	●	●	●	
Overload / short-circuit protection	Thermal magnetic		●	●	●	●	—	—	—	—	
	Electronic		●	●	●	●	●	●	●	●	
		with neutral protection (Off-0.5-1-OSN) (1)	●	●	●	●	●	●	●	●	
		with ground-fault protection	●	●	●	●	●	●	●	●	
	with zone selective interlocking (ZSI) (2)	●	●	●	●	●	●	●	●		
Display / I, U, f, P, E, THD measurements / interrupted-current measurement			●	●	●	●	●	●	●	●	
Options	Operating assistance		●	●	●	●	●	●	●	●	
	Counters		●	●	●	●	●	●	●	●	
	Histories and alarms		●	●	●	●	●	●	●	●	
	Metering Com		●	●	●	●	●	●	●	●	
	Device status/control Com		●	●	●	●	●	●	●	●	
Dimensions (mm) W x H x D	Fixed, front connections	2/3P	105 x 161 x 86	105 x 161 x 86	105 x 161 x 86		140 x 255 x 110		140 x 255 x 110		
		4P	140 x 161 x 86	140 x 161 x 86	140 x 161 x 86		185 x 255 x 110		185 x 255 x 110		
Mass (kg)	Fixed, front connections	2/3P	2.05	2.2	2.4		6.05		6.2		
		4P	2.4	2.6	2.8		7.90		8.13		
Connection terminals	Pitch	With/without spreaders	35/45 mm	35/45 mm	35/45 mm		45/52.5 mm 45/70 mm		45/52.5 mm 45/70 mm		
Large Cu or Al cables	Cross-section	mm ²	300	300	300		4 x 240		4 x 240		

Molded Case Circuit Breakers

BX series (100AF to 630AF)

Functions and characteristics

■ BX trip units

With Control trip units, BX stands out from the crowd. Thanks to the new generation of sensors and its processing capability, protection is enhanced even further. It also provides measurements and operating information.

• Thermal-magnetic or Control unit?

Thermal-magnetic trip units protect against overcurrents and short-circuits using tried and true techniques. But today, installation optimisation and energy efficiency have become decisive factors and electronic trip units offering more advanced protection functions combined with measurements are better suited to these needs.

Control units combine reflex tripping and intelligent operation. Thanks to digital electronics, trip units have become faster as well as more accurate and reliable. Wide setting ranges make installation upgrades easier. Designed with processing capabilities, Control units can provide measurement information and device operating assistance. With this information, users can avoid or deal more effectively with disturbances and can play a more active role in system operation. They can manage the installation, anticipate on events and plan any necessary servicing.

• Accurate measurements for complete protection

BX devices take advantage of the vast experience acquired since the launch of DW circuit breakers equipped with Control units. From 40 amperes on up to the short-circuit currents, they offer excellent measurement accuracy. This is made possible by a new generation of current transformers combining "iron-core" sensors for self-powered electronics and "air-core" sensors (Rogowski toroids) for measurements. The protection functions are managed by an ASIC component that is independent of the measurement functions. This independence ensures immunity to conducted and radiated disturbances and a high level of reliability.

• Numerous security functions

- Torque-limiting screws

The screws secure the trip unit to the circuit breaker. When the correct tightening torque is reached, the screw heads break off. Optimum tightening avoids any risk of temperature rise. A torque wrench is no longer required.

- Easy and sure changing of trip units

All trip units are interchangeable, without wiring. A mechanical mismatch-protection system makes it impossible to mount a trip unit on a circuit breaker with a lower rating.

- "Ready" LED for a continuous self-test

The LED on the front of the electronic trip units indicates the result of the self-test runs continuously on the measurement system and the tripping release. As long as the green LED is flashing, the links between the CTs, the processing electronics and the Mitop release are operational. The circuit breaker is ready to protect. No need for a test kit. A minimum current of 15 to 50 A, depending on the device, is required for this indication function.

- A patented dual adjustment system for protection functions.

Available on Control units 5 / 6, the system consists of:

- an adjustment using dials sets the maximum value
- an adjustment, made via the keypad or remotely, fine-tunes the setting. This setting may not exceed the first one. It can be read directly on the Control unit screen, to within one ampere and a fraction of a second.

• Coordinated tripping systems

BX detects faults even faster and its tripping time is reduced. It protects the installation better and limits contact wear.

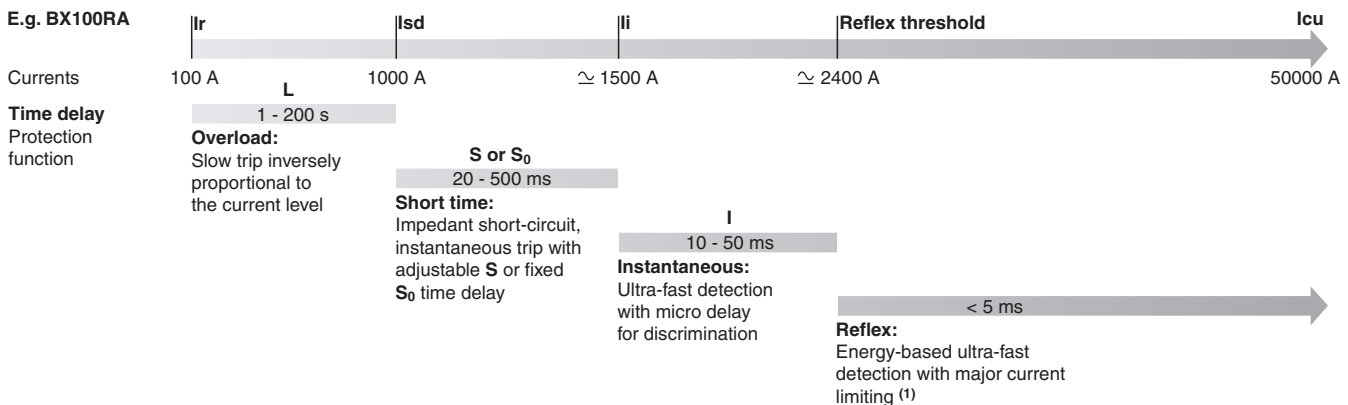

⁽¹⁾ This tripping system is completely independent of the trip unit. Because it directly actuates the mechanism, it precedes the trip unit by a few milliseconds.

Understanding the names of Control units

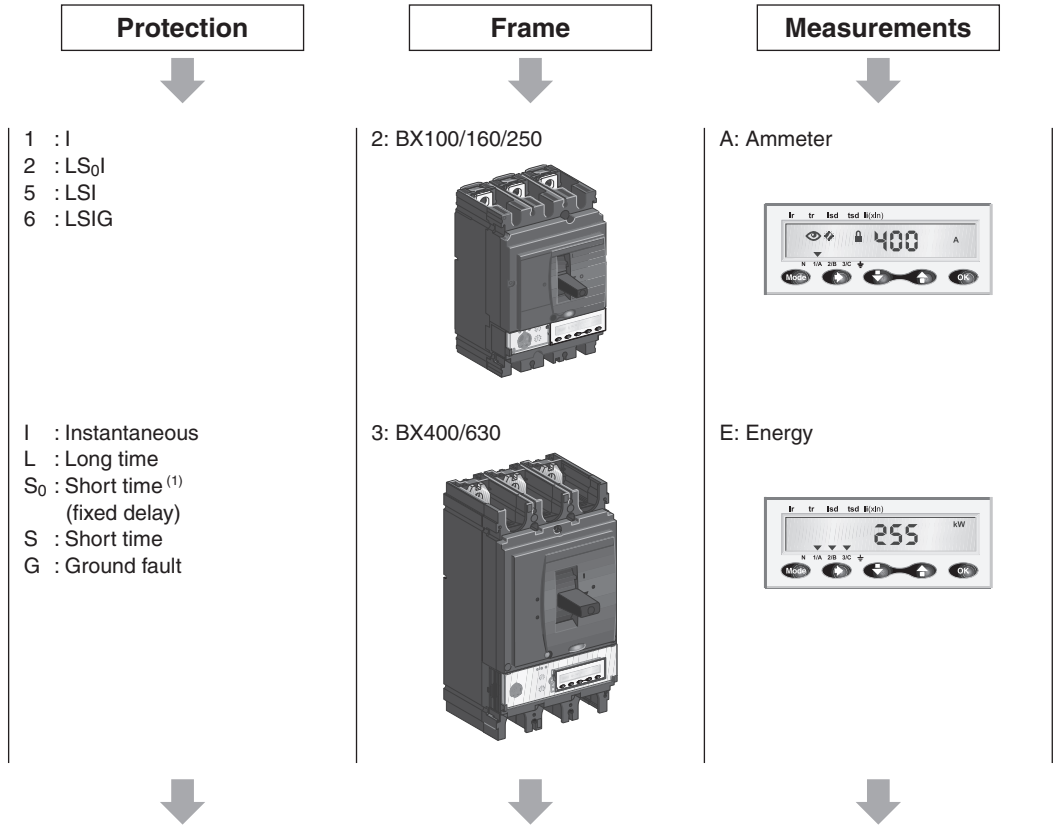

Examples

Control unit 2	LS ₀ I	400 or 630 A	
Control unit 5A	LSI	100, 160 or 250 A	Ammeter

(1) LS₀I protection is standard on unit 2. To ensure discrimination, it offers short-time protection S₀ with a non-adjustable delay and instantaneous protection.

Molded Case Circuit Breakers

BX series (100AF to 630AF)

Functions and characteristics

■ Overview of trip units for BX

BX offers a range of trip units in interchangeable cases, whether they are magnetic, thermal-magnetic or electronic. Versions 5 and 6 of the electronic trip unit offer communication and metering. Using Control unit sensors and intelligence, BX supplies all the information required to manage the electrical installation and optimise energy use.

BX100/160/250

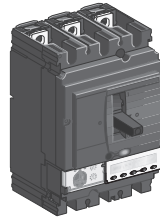

BX400/630

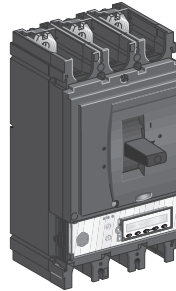

Type of protection and application

TM-D thermal-magnetic

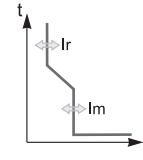

■ Distribution

Circuit breakers and trip units

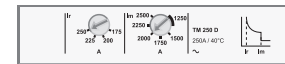





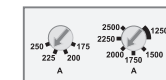

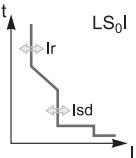
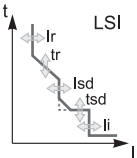
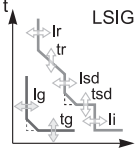
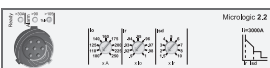

TM-D Distribution

Settings and indications

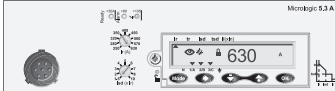
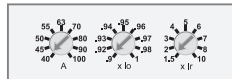
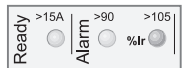

Adjustment and reading
 Pick-up set in amps using dials
 Non-adjustable time delay

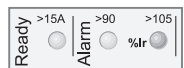
Molded Case Circuit Breakers BX series (100AF to 630AF) Functions and characteristics

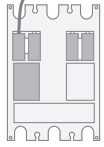
Control unit 2 electronic	Control unit 5 / 6 A or E electronic	
 <p>■ Distribution ■ Service connection (public distribution)</p>	 <p>■ Distribution and generators</p> <p>A : current metering functions E : current and energy metering functions.</p>	 <p>■ Distribution and generators</p>
 <p>2 Distribution</p>	 <p>5A Distribution and generators 5E Distribution and generators</p>	<p>6A Distribution and generators 6E Distribution and generators</p>
 <p>2 Distribution</p>	 <p>5A Distribution and generators 5E Distribution and generators</p>	<p>6A Distribution and generators 6E Distribution and generators</p>
 <p>Adjustment and reading Pick-up set in amps with fine adjustment using dials Non-adjustable time delay</p>  <p>Front indications</p>  <p>Test connector</p> <p>Self test</p>	 <p>Adjustment and reading Pick-up set in amps</p>  <p>Fine adjustment via keypad</p>  <p>Adjustable time delays</p>  <p>Front indications</p>  <p>Test connector</p> <p>Self test</p>	  <p>Communication to Modbus</p>

Molded Case Circuit Breakers

BX series (100AF to 630AF)

Functions and characteristics

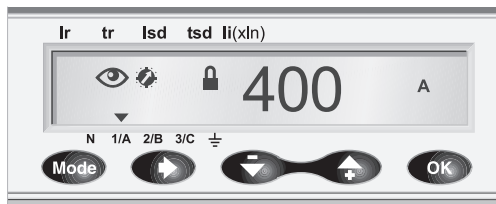

Ammeter (A)

I measurements

Current measurements

- Phase and neutral currents I1, I2, I3, IN
- Average current of the 3 phases Iavg
- Highest current of the three phases Imax
- Ground-fault current Ig (Control units 6.2 / 6.3 A)
- Maximeter/minimeter for I measurements

Operating and maintenance assistance

Indications, alarms and histories

- Indication of fault types
- Alarms for high/low alarm thresholds linked to I measurements
- Trip, alarm and operating histories
- Time-stamped tables for settings and maximeters

Maintenance indicators

- Operation, trip and alarm counters
- Operating hours counter
- Contact wear
- Load profile and thermal image

Communication

- Modbus with add-on module

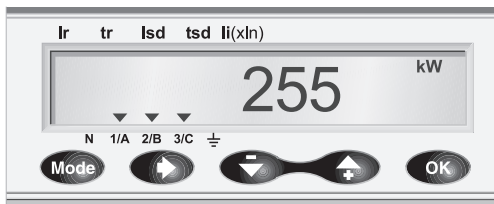

Energy (E)

I, U, f, P, E, THD measurements

Current measurements

- Phase and neutral currents I1, I2, I3, IN
- Average current of the 3 phases Iavg
- Highest current of the three phases Imax
- Ground-fault current Ig (Control units 6.2 / 6.3 A)
- Maximeter/minimeter for I measurements
- Current unbalance between phases

Voltage measurements

- Phase-to-phase (U) et phase-to-neutral (V) voltages
- Average voltages Uavg, Vavg
- Ph-Ph (U) and Ph-N (V) voltage unbalance

Frequency measurements

- Frequency (f)

Power-quality indicators

- Total harmonic distortion (THD) for current and voltage

Power measurements

- Active, reactive and apparent power, total and per phase
- Power factor and $\cos \varnothing$

Maximeters/minimeters

- For all I, U, f, P, E measurements

Demand current and power measurements

- Demand values, total and per phase
- Maximum demand

Energy metering

- Active, reactive and apparent energy, total and per phase

Operating and maintenance assistance

Indications, alarms and histories

- Indication of fault types
- Alarms for high/low thresholds linked to I, U, f, P, E measurements
- Trip, alarm and operating histories
- Time-stamped tables for settings and I, U, f, P, E maximeters

Maintenance indicators

- Operation, trip and alarm counters
- Operating hours counter
- Contact wear
- Load profile and thermal image

Communication

- Modbus with add-on module

Molded Case Circuit Breakers

BX series (100AF to 630AF)

Protection of distribution systems

■ TM-D thermal-magnetic trip unit

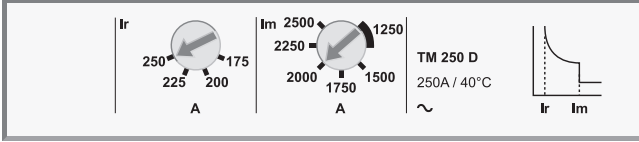

TM thermal-magnetic trip unit can be used on BX100/160/250 circuit breakers with performance levels R/H.

- TM-D, for the protection of distribution cables

Circuit breakers equipped with thermal-magnetic trip units are used mainly in industrial and commercial electrical distribution applications:

- TM-D, for protection of cables on distribution systems supplied by transformers

Protection



Thermal protection (Ir)

Thermal overload protection based on a bimetal strip providing an inverse time curve I^2t , corresponding to a temperature rise limit. Above this limit, the deformation of the strip trips the circuit breaker operating mechanism.

This protection operates according to:

- Ir that can be adjusted in amps from 0.7 to 1 times the rating of the trip unit (16 A to 250 A), corresponding to settings from 11 to 250 A for the range of trip units
- a non-adjustable time delay, defined to ensure protection of the cables.
- TM-D: fixed pick-up, Im, for 16 to 160 A ratings and adjustable from 5 to 10 x In for 200 and 250 A ratings
- fixed pick-up for 16 to 63 A ratings.

Protection versions

- 3-pole:
 - 3P 3D: 3-pole frame (3P) with detection on all 3 poles (3D)
- 4-pole:
 - 4P 4D: 4-pole frame (4P) with detection on all 4 poles (same threshold for phases and neutral).

Note: All the trip units have a transparent lead-sealable cover that protects access to the adjustment dials.

Molded Case Circuit Breakers BX series (100AF to 630AF) Protection of distribution systems

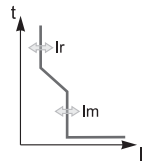

Thermal-magnetic trip units			TM16D to 250D											
Ratings (A)	In at 40 °C ⁽¹⁾		16	25	32	40	50	63	80	100	125	160	200	250
Circuit breaker	BX100		○	○	○	○	○	○	○	○	○	○	○	○
		BX160	–	–	○	○	○	○	○	○	○	○	○	○
		BX250	–	–	–	–	–	○	○	○	○	○	○	○
Thermal protection	Pick-up (A) tripping between 1.05 and 1.20 Ir	$I_r = I_n \times \dots$	adjustable in amps from 0.7 to 1 x In											
	Time delay (s)	tr	non-adjustable											
		tr at 1.5 x In	120 to 400											
		tr at 6 x Ir	15											
Magnetic protection	Pick-up (A) accuracy ±20 %	Im	fixed										adjustable	
		BX100	190	300	400	500	500	500	640	800				
		BX160/250	190	300	400	500	500	500	640	800	1250	1250	5 to 10xIn	
	Time delay	tm	fixed											
Neutral protection	Fully protected neutral	4P 4D	1 x Ir											

(1) For temperatures greater than 40 °C, the thermal protection characteristics are modified. See the temperature derating table.

Molded Case Circuit Breakers BX series (100AF to 630AF) Protection of distribution systems

Control unit 2

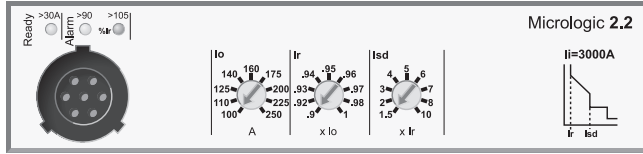

Circuit breakers equipped with unit 2 can be used to protect distribution systems supplied by transformers.

Protection

Settings are made using the adjustment dials with fine adjustment possibilities.

Overloads: Long time protection (I_r)

Inverse time protection against overloads with an adjustable current pick-up I_r set using a dial and a non-adjustable time delay t_r .

Short-circuits: Short-time protection with fixed time delay (I_{sd})

Protection with an adjustable pick-up I_{sd} . Tripping takes place after a very short delay used to allow discrimination with the downstream device.

Short-circuits: Non-adjustable instantaneous protection

Instantaneous short-circuit protection with a fixed pick-up.

Neutral protection

- On 3-pole circuit breakers, neutral protection is not possible.
- On four-pole circuit breakers, neutral protection may be set using a three-position switch:
 - 4P 3D: neutral unprotected
 - 4P 3D + N/2: neutral protection at half the value of the phase pick-up, i.e. $0.5 \times I_r$
 - 4P 4D: neutral fully protected at I_r .

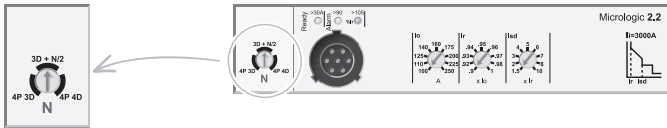

Indications

Front indications

- Green "Ready" LED: flashes slowly when the circuit breaker is ready to trip in the event of a fault.
- Orange overload pre-alarm LED: steady on when $I > 90\% I_r$.
- Red overload LED: steady on when $I > 105\% I_r$.

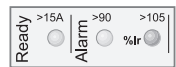

Remote indications

An overload trip signal can be remotely indicated by installing an SDx relay module inside the circuit breaker. This module receives the signal from the Control unit electronic trip unit via an optical link and makes it available on the terminal block. The signal is cleared when the circuit breaker is reclosed.

Control unit 2 can be used on BX100 to 630 circuit breakers with performance levels R/H.

They provide:

- standard protection of distribution cables
- indication of:
 - overloads (via LEDs)



SDx remote indication relay module with its terminal block.

Note: All the trip units have a transparent lead-sealable cover that protects access to the adjustment dials.

Molded Case Circuit Breakers BX series (100AF to 630AF) Protection of distribution systems

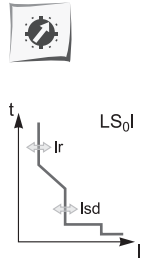

Control unit 2														
Ratings (A)	In at 40 °C ⁽¹⁾			40	100	160	250	400	630					
	Circuit breaker	BX100		○	○	–	–	–	–					
		BX160		○	○	○	–	–	–					
		BX250		○	○	○	○	–	–					
		BX400 BX630		–	–	–	○	○	–	○	○			
[L] Long-time protection	Pick-up (A) tripping between 1.05 and 1.20 Ir	In = 40 A	Io=	value depending on trip unit rating (In) and setting on dial										
		In = 100 A	Io=	18	18	20	23	25	28	32	36	40		
		In = 160 A	Io=	40	45	50	55	63	70	80	90	100		
		In = 250 A (BX250)	Io=	63	70	80	90	100	110	125	150	160		
		In = 250 A (BX400)	Io=	100	110	125	140	160	175	200	225	250		
		In = 400 A	Io=	70	100	125	140	160	175	200	225	250		
		In = 630 A	Io=	160	180	200	230	250	280	320	360	400		
		Ir = Io x ...	Io=	250	280	320	350	400	450	500	570	630		
Time delay (s) accuracy 0 to -20%	tr	non-adjustable												
		1.5 x Ir	400											
		6 x Ir	16											
		7.2 x Ir	11											
Thermal memory			20 minutes before and after tripping											
[S ₀] Short-time protection with fixed time delay	Pick-up (A) accuracy ±10 %	Isd = Ir x ...	1.5	2	3	4	5	6	7	8	10			
		Time delay (ms)	tsd	non-adjustable										
			Non-tripping time	10										
		Maximum break time	80											
[I] Instantaneous protection	Pick-up (A) accuracy ±15 %	li non-adjustable	600	1500	2400	3000	4800	6900						
		Non-tripping time	10 ms											
		Maximum break time	50 ms for I > 1.5 li											

(1) If the trip units are used in high-temperature environments, the Control unit setting must take into account the thermal limitations of the circuit breaker. See the temperature derating table.

Molded Case Circuit Breakers BX series (100AF to 630AF) Protection of distribution systems

■ Control unit 5 / 6 A or E

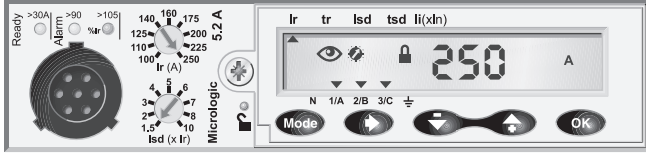

Protection

Settings can be adjusted in two ways, using the dials and/or the keypad. The keypad can be used to make fine adjustments in 1 A steps below the maximum value defined by the setting on the dial. Access to setting modifications via the keypad is protected by a locking function displayed on the screen and controlled by a microswitch. The lock is activated automatically if the keypad is not used for 5 minutes. Access to the microswitch is protected by a transparent lead-sealable cover. With the cover closed, it is still possible to display the various settings and measurements using the keypad.

Overloads: Long time protection (Ir)

Inverse time protection against overloads with an adjustable current pick-up Ir set using a dial or the keypad for fine adjustments. The time delay tr is set using the keypad.

Short-circuits: Short-time protection (Isd)

Short-circuit protection with an adjustable pick-up Isd and adjustable time delay tsd, with the possibility of including a portion of an inverse time curve (I^2t On).

Short-circuits: Instantaneous protection (Ii)

Instantaneous protection with adjustable pick-up Ii.

Additional ground fault protection (Ig) on Control unit 6

Residual type ground-fault protection with an adjustable pick-up Ig (with Off position) and adjustable time delay tg. Possibility of including a portion of an inverse time curve (I^2t On).

Neutral protection

- On 4-pole circuit breakers, this protection can be set via the keypad:
 - Off: neutral unprotected
 - 0.5: neutral protection at half the value of the phase pick-up, i.e. $0.5 \times I_r$
 - 1.0: neutral fully protected at I_r
 - OSN: Oversized neutral protection at 1.6 times the value of the phase pick-up.
- Used when there is a high level of 3rd order harmonics (or orders that are multiples of 3) that accumulate in the neutral and create a high current. In this case, the device must be limited to $I_r = 0.63 \times I_n$ for the maximum neutral protection setting of 1.6 x Ir.

- With 3-pole circuit breakers, the neutral can be protected by installing an external neutral sensor with the output (T1, T2) connected to the trip unit.

Zone selective interlocking (ZSI)

A ZSI terminal block may be used to interconnect a number of Control units to provide zone selective interlocking for short-time (Isd) and ground-fault (Ig) protection, without a time delay. For BX100 to 250, the ZSI function is available only in relation to the upstream circuit breaker (ZSI out).

Display of type of fault

On a fault trip, the type of fault (Ir, Isd, Ii, Ig), the phase concerned and the interrupted current are displayed. An external power supply is required.

Indications.....

Front indications



- Green "Ready" LED: flashes slowly when the circuit breaker is ready to trip in the event of a fault.
- Orange overload pre-alarm LED: steady on when $I > 90 \% I_r$.
- Red overload LED: steady on when $I > 105 \% I_r$.

Remote indications

An SDx relay module installed inside the circuit breaker can be used to remote the following information:

- overload trip
- overload prealarm (Control unit 5) or ground fault trip (Control unit 6).

This module receives the signal from the Control unit electronic trip unit via an optical link and makes it available on the terminal block. The signal is cleared when the circuit breaker is closed.

These outputs can be reprogrammed to be assigned to other types of tripping or alarm. The module is described in detail in the section dealing with accessories.

Control units 5 / 6 A (Ammeter) or E (Energy) can be used on BX100 to 630 circuit breakers with performance levels B/F/H/N/S/L. They all have a display unit.

They offer basic LSI protection (unit 5) or LSI and ground-fault protection G (unit 6).

They also offer measurement, alarm and communication functions.

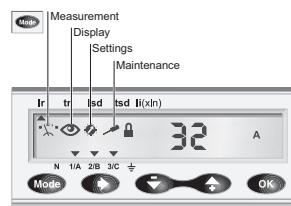

Trip unit menus.

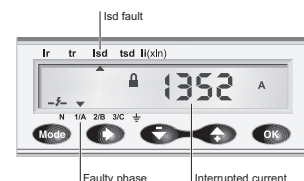

Display of interrupted current.

Note: All the trip units have a transparent lead-sealable cover that protects access to the adjustment dials.

Molded Case Circuit Breakers BX series (100AF to 630AF) Protection of distribution systems

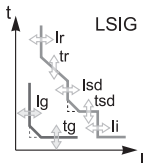
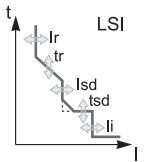

Protection	Control units 5 / 6 A or B												
Ratings (A)	In at 40 °C ⁽¹⁾		40 ⁽²⁾	100	160	250	400	630					
	Circuit breaker	BX100	○	○	—	—	—	—					
		BX160	○	○	○	—	—	—					
		BX250	○	○	○	○	—	—					
		BX400	—	—	—	—	○	—					
		BX630	—	—	—	—	○	○					
[L] Long-time protection	Pick-up (A) tripping between 1.05 and 1.20 Ir	Ir = ...	dial setting	value depending on trip unit rating (In) and setting on dial									
		In = 40 A	Io=	18	18	20	23	25	28	32	36	40	
		In = 100 A	Io=	40	45	50	55	63	70	80	90	100	
		In = 160 A	Io=	63	70	80	90	100	110	125	150	160	
		In = 250 A	Io=	70	100	125	140	160	175	200	225	250	
		In = 400 A	Io=	160	180	200	230	250	280	320	360	400	
		In = 630 A	Io=	250	280	320	350	400	450	500	570	630	
			keypad setting	Fine adjustment in 1 A steps below maximum value set on dial									
	Time delay (s) accuracy 0 to -20%	tr = ...	keypad setting	0.5	1	2	4	8	16				
		1.5 x Ir		15	25	50	100	200	400				
		6 x Ir		0.5	1	2	4	8	16				
		7.2 x Ir		0.35	0.7	1.4	2.8	5.5	11				
			Thermal memory	20 minutes before and after tripping									
[S] Short-time protection with adjustable time delay	Pick-up (A) accuracy ±10 %	Isd = Ir x ...	dial setting for unit 5	1.5	2	3	4	5	6	7	8	10	
			dial setting for unit 6	Adjustment in steps of 0.5 x Ir over the range 1.5 x Ir to: 15 x Ir (40 to 160 A), 12 x Ir (250 to 400 A) or 11 x Ir (630 A)									
	Time delay (ms)	tsd = ...	keypad setting	I ² Off	0	0.1	0.2	0.3	0.4				
				I ² On	—	0.1	0.2	0.3	0.4				
[I] Instantaneous protection	Pick-up (A) accuracy ±15 %	li = In x	keypad setting	Adjustment in steps of 0.5 x Ir over the range 1.5 x Ir to: 15 x Ir (40 to 160 A), 12 x Ir (250 to 400 A) or 11 x Ir (630 A)									
		Non-tripping time		10 ms									
		Maximum break time		50 ms for I > 1.5 li									
[G] Ground-fault protection - for Control unit 6 A or E	Pick-up (A) accuracy ±10 %	Ig = In x	dial setting						0.7	0.8	0.9	1	Off
		In = 40 A		0.4	0.4	0.5	0.6	0.7	0.8	0.9	1	Off	
		In > 40 A		0.2	0.3	0.4	0.5	0.6	0.7	0.8	1	Off	
				Fine adjustment in 0.05 A steps using the keypad									
	Time delay (s)	tg = ...	keypad setting	I ² Off	0	0.1	0.2	0.3	0.4				
				I ² On	—	0.1	0.2	0.3	0.4				
			Non-tripping time (ms)	20 80 140 230 350									
			Maximum break time (ms)	80 140 200 320 500									
	Test	Ig function		built-in									

(1) If the trip units are used in high-temperature environments, the Control unit setting must take into account the thermal limitations of the circuit breaker. See the temperature derating table.
(2) For 40 A rating, the neutral N/2 adjustment is not possible.

Molded Case Circuit Breakers

BX series (100AF to 630AF)

Power Meter functions

■ Control unit 5 / 6 A or E

Unit A and E measurement functions are made possible by intelligence and the accuracy of the sensors. They are handled by a microprocessor that operates independent of protection functions.

Display



Control unit LCD

The user can display all the protection settings and the main measurements on the LCD screen of the trip unit.

- Unit A: instantaneous rms current measurements.
 - Unit E: voltage, frequency and power measurements and energy metering,
- in addition to the measurements offered by Unit A
To make the display available under all conditions and increase operating comfort, an external power supply is recommended for Unit A.

It is indispensable to:

- display faults and interrupted current measurements
- use all the functions of Unit E (e.g. metering of low power and energy values)

Measurements



Instantaneous rms measurements

The unit A and E continuously display the RMS value of the highest current of the three phases and neutral (I_{max}). The navigation buttons  can be used to scroll through the main measurements.

In the event of a fault trip, the current interrupted is memorised.

The unit A measures phase, neutral, ground fault currents.

The unit E offers voltage, frequency and power measurements in addition to the measurements provided by unit A.

Maximeters / minimeters

Every instantaneous measurement provided by unit A or E can be associated with a maximeter/minimeter. The maximeters for the highest current of the 3 phases and neutral, the demand current and power can be reset via the trip unit keypad, the FDM121 display unit or the communication system.

Energy metering

The unit E also measures the energy consumed since the last reset of the meter. The active energy meter can be reset via the keypad and the FDM121 display unit or the communication system.

Demand and maximum demand values

unit E also calculates demand current and power values.

These calculations can be made using a block or sliding interval that can be set from 5 to 60 minutes in steps of 1 minute. The window can be synchronised with a signal sent via the communication system. Whatever the calculation method, the calculated values can be recovered on a PC via Modbus communication.

Ordinary spreadsheet software can be used to provide trend curves and forecasts based on this data. They will provide a basis for load shedding and reconnection operations used to adjust consumption to the subscribed power.

Power quality

unit E calculates power quality indicators taking into account the presence of harmonics up to the 15th order, including the total harmonic distortion (THD) of current and voltage.

In addition to protection functions, Control units 5 / 6 offer all the functions of Power Meter products as well as operating-assistance for the circuit breaker.

- display of settings
- measurement functions:
 - Ammeter (A)
 - Energy (E)
- alarms
- time-stamped histories and event tables
- maintenance indicator
- communication

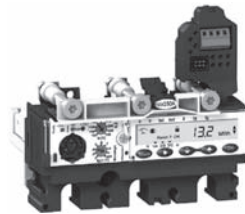

Control unit built-in LCD display showing an energy measurement.

Molded Case Circuit Breakers BX series (100AF to 630AF) Power Meter functions



Control units 5 / 6 integrated Power Meter functions

			Type		Display
			A	E	Control unit LCD
Display of protection settings					
Pick-ups (A) and delays	All settings can be displayed	I _r , t _r , I _{sd} , t _{sd} , I _i , I _g , t _g	<input type="radio"/>	<input type="radio"/>	<input type="radio"/>
Measurements					
Instantaneous rms measurements					
Currents (A)	Phases and neutral	I ₁ , I ₂ , I ₃ , I _N	<input type="radio"/>	<input type="radio"/>	<input type="radio"/>
	Average of phases	$I_{avg} = (I_1 + I_2 + I_3) / 3$	<input type="radio"/>	<input type="radio"/>	–
	Highest current of the 3 phases and neutral	I _{max} of I ₁ , I ₂ , I ₃ , I _N	<input type="radio"/>	<input type="radio"/>	<input type="radio"/>
	Ground fault (unit 6)	% I _g (pick-up setting)	<input type="radio"/>	<input type="radio"/>	<input type="radio"/>
	Current unbalance between phases	% I _{avg}	–	<input type="radio"/>	–
Voltages (V)	Phase-to-phase	U ₁₂ , U ₂₃ , U ₃₁	–	<input type="radio"/>	<input type="radio"/>
	Phase-to-neutral	V _{1N} , V _{2N} , V _{3N}	–	<input type="radio"/>	<input type="radio"/>
	Average of phase-to-phase voltages	$U_{avg} = (U_{12} + U_{21} + U_{23}) / 3$	–	<input type="radio"/>	–
	Average of phase-to-neutral voltages	$V_{avg} = (V_{1N} + V_{2N} + V_{3N}) / 3$	–	<input type="radio"/>	–
	Ph-Ph and Ph-N voltage unbalance	% U _{avg} and % V _{avg}	–	<input type="radio"/>	–
	Phase sequence	1-2-3, 1-3-2	–	<input type="radio"/>	<input type="radio"/>
	Frequency (Hz)	Power system	f	–	<input type="radio"/>
Power	Active (kW)	P, total / per phase	– / –	<input type="radio"/> / <input type="radio"/>	<input type="radio"/> / –
	Reactive (kVAR)	Q, total / per phase	– / –	<input type="radio"/> / <input type="radio"/>	<input type="radio"/> / –
	Apparent (kVA)	S, total / per phase	– / –	<input type="radio"/> / <input type="radio"/>	<input type="radio"/> / –
	Power factor and cos φ (fundamental)	PF and cos φ, total and per phase	–	<input type="radio"/>	–
Maximeters / minimeters					
Associated with instantaneous rms measurements		Reset via Control unit or FDM121 display unit	<input type="radio"/>	<input type="radio"/>	–
Energy metering					
Energy	Active (kW), reactive (kVARh), apparent (kVAh)	Total since last reset Absolute or signed mode ⁽¹⁾	–	<input type="radio"/>	<input type="radio"/>
Demand and maximum demand values					
Demand current (A)	Phases and neutral	Present value on the selected window	–	<input type="radio"/>	–
		Maximum demand since last reset	–	<input type="radio"/>	–
Demand power	Active (kWh), reactive (kVAR), apparent (kVA)	Present value on the selected window	–	<input type="radio"/>	–
		Maximum demand since last reset	–	<input type="radio"/>	–
Calculation window	Sliding, fixed or com-synchronised	Adjustable from 5 to 60 minutes in 1 minute steps ⁽²⁾	–	<input type="radio"/>	–
Power quality					
Total harmonic distortion (%)	Of voltage with respect to rms value	THDU, THDV of the Ph-Ph and Ph-N voltage	–	<input type="radio"/>	–
	Of current with respect to rms value	THDI of the phase current	–	<input type="radio"/>	–

(1) Absolute mode: E absolute = E out + E in; Signed mode: E signed = E out - E in.

(2) Available via the communication system only.

Additional technical characteristics

Measurement accuracy

Accuracies are those of the entire measurement system, including the sensors:

- current: Class 1 as per IEC 61557-12
- voltage: 0.5 %
- power and energy: Class 2 as per IEC 61557-12
- frequency: 0.1 %.

Molded Case Circuit Breakers BX series (100AF to 630AF) Operating-assistance functions

■ Control unit 5 / 6 A or E

Personalised alarms with time-stamping.....



Alarm types

The user can assign an alarm to all Control units A or E measurements or events:

- up to 12 alarms can be used together:
 - two alarms are predefined and activated automatically:
 - Unit 5: overload (Ir)
 - Unit 6: overload (Ir) and ground fault (Ig)
 - thresholds, priorities and time delays can be set for ten other alarms.
- the same measurement can be used for different alarms to precisely monitor certain values, e.g. the frequency or the voltage
- alarms can also be assigned to various states: phase lead/lag, four quadrants, phase sequence
- selection of display priorities, with pop-up possibility
- alarm time-stamping.

Alarm settings

Alarms cannot be set via the keypad. They are set via communication with the PC. Set-up includes the threshold, priority, activation delay before display and deactivation delay. It is also possible to reprogram the standard assignment for the two SDx relay outputs to user-selected alarms.

Alarm reading

Remote alarm indications.

- Remote indications via SDx relay with two output contacts for alarms.

Histories and event tables.....



Control units A and E have histories and event tables that are always active.

Three types of time-stamped histories

- Tripping due to overruns of Ir, I_{sd}, I_i, Ig: last 17 trips
 - Alarms: last 10 alarms
 - Operating events: last 10 events
- Each history record is stored with:
- indications in clear text in a number of user-selectable languages
 - time-stamping: date and time of event
 - status: pick-up / drop-out

Two types of time-stamped event tables

- Protection settings.
- Minimizers / maximizers.

Display of alarms and tables

The time-stamped histories and event tables may be displayed on a PC via the communication system.

Embedded memory

Units A and E have a non-volatile memory that saves all data on alarms, histories, event tables, counters and maintenance indicators even if power is lost.

Maintenance indicators.....



Units A and E have indicators for, among others, the number of operating cycles, contact wear and operating times (operating hours counter) of the BX circuit breaker.

It is possible to assign an alarm to the operating cycle counter to plan maintenance.

The various indicators can be used together with the trip histories to analyse the level of stresses the device has been subjected to.

The information provided by the indicators cannot be displayed on the Control units LCD. It is displayed on the PC via the communication system.

Management of installed devices

Each circuit breaker equipped with a Control unit 5 or 6 can be identified via the communication system:

- serial number
- firmware version
- hardware version
- device name assigned by the user.

This information together with the previously described indications provides a clear view of the installed devices.

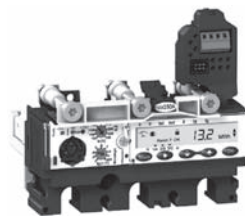

Control unit built-in LCD display showing an energy measurement.

Molded Case Circuit Breakers BX series (100AF to 630AF) Operating-assistance functions



Control units 5 / 6 operating assistance functions

			Type		Display
			A	E	Control unit LCD
Operating assistance					
Personalised alarms					
Settings	Up to 10 alarms assigned to all A and E measurements ⁽²⁾		<input type="radio"/>	<input type="radio"/>	–
	Phase lead/lag, four quadrants, phase sequence, display priority selection ⁽²⁾		–	<input type="radio"/>	–
Display	Alarms / tripping		<input type="radio"/>	<input type="radio"/>	– / <input type="radio"/>
Remote indications	Activation of two dedicated contacts on SDx module		<input type="radio"/>	<input type="radio"/>	–
Time-stamped histories (ms)					
Trips (last 17)	Cause of tripping	Ir, lsd, li (Unit 5, 6)	<input type="radio"/>	<input type="radio"/>	–
		Ig (Unit 6)	<input type="radio"/>	<input type="radio"/>	–
		Phase fault	<input type="radio"/>	<input type="radio"/>	–
		Interrupted current value	<input type="radio"/>	<input type="radio"/>	–
Alarms (last 10)			<input type="radio"/>	<input type="radio"/>	–
Operating events (last 10)	Event types	Modification of protection setting by dial	–	<input type="radio"/>	–
		Opening of keypad lock	–	<input type="radio"/>	–
		Test via keypad	–	<input type="radio"/>	–
		Test via external tool	–	<input type="radio"/>	–
		Time setting (date and time)	–	<input type="radio"/>	–
		Reset for maximeter/minimeter and energy meter	<input type="radio"/>	<input type="radio"/>	–
Time stamping (date and time, text, status)			<input type="radio"/>	<input type="radio"/>	–
Time-stamped event tables					
Protection settings	Setting modified (value displayed)	Ir tr lsd tsd li lg tg ⁽²⁾	<input type="radio"/>	<input type="radio"/>	–
	Time-stamping	Date and time of modification ⁽²⁾	<input type="radio"/>	<input type="radio"/>	–
	Previous value	Value before modification ⁽²⁾	<input type="radio"/>	<input type="radio"/>	–
Min/Max	Values monitored	I1 I2 I3 IN	<input type="radio"/>	<input type="radio"/>	–
		U12 U23 U31 f	–	<input type="radio"/>	–
	Time-stamping of each value	Date and time of min/max record	<input type="radio"/>	<input type="radio"/>	–
	Current min/max value	Min/max value	<input type="radio"/>	<input type="radio"/>	–
Maintenance indicators					
Counter	Mechanical cycles ⁽¹⁾	Assignable to an alarm	<input type="radio"/>	<input type="radio"/>	–
	Electrical cycles ⁽¹⁾	Assignable to an alarm	<input type="radio"/>	<input type="radio"/>	–
	Trips	One per type of trip ⁽²⁾	<input type="radio"/>	<input type="radio"/>	–
	Alarms	One for each type of alarm ⁽²⁾	<input type="radio"/>	<input type="radio"/>	–
	Hours	Total operating time (hours) ⁽²⁾	<input type="radio"/>	<input type="radio"/>	–
Indicator	Contact wear		<input type="radio"/>	<input type="radio"/>	–
Load profile	Hours at different load levels	% of hours in four current ranges: 0-49 % In, 50-79 % In, 80-89 % In and u 90 % In	<input type="radio"/>	<input type="radio"/>	–

(1) The BSCM module (page 29) is required for these functions.

(2) Also available via the communication system.

Additional technical characteristics

Contact wear

Each time BX opens, the Control units 5 / 6 measures the interrupted current and increments the contact-wear indicator as a function of the interrupted current, according to test results stored in memory. Breaking under normal load conditions results in a very slight increment. The indicator value may be read on the FDM121 display. It provides an estimation of contact wear calculated on the basis of the cumulative forces affecting the circuit breaker. When the indicator reaches 80 %, it is advised to replace the circuit breaker to ensure the availability of the protected equipment.

Circuit breaker load profile

Units 5 / 6 calculates the load profile of the circuit breaker protecting a load circuit. The profile indicates the percentage of the total operating time at four current levels (% of breaker In):

- 0 to 49 % In
- 50 to 79 % In
- 80 to 89 % In
- ≥ 90 % In.

This information can be used to optimise use of the protected equipment or to plan ahead for extensions.

Molded Case Circuit Breakers BX series (100AF to 630AF) Communication

■ Communications modules

Four functional levels

The BX can be integrated in a Modbus communication environment. Four functional levels can be used separately or combined.

Communication of status indications

This level is compatible with all BX circuit breakers, whatever the trip unit, and with all switch-disconnectors. Using the BSCM module, the following information is accessible:

- ON/OFF position (O/F)
- trip indication (SD)
- fault-trip indication (SDE).

Communication of commands

Also available on all circuit breakers and switch-disconnectors, this level (communicating remote control) can be used to:

- open
- close
- reset.

Communication of measurements with unit 5 / 6 A or E

This level provides access to all available information:

- instantaneous values A, E, P, H
- demand values E, P, H
- maximeters/minimeters A, E, P, H
- energy metering E, P, H
- demand current and power E, P, H
- power quality P, H.

Communication of operating assistance with unit 5 / 6 A or E

- protection and alarm settings P, H
- time-stamped histories E, P, H
- event tables P, H
- maintenance indicators E, P, H.

All BX devices can be equipped with the communication function via a prewired connection system and a Modbus network interface. The interface can be connected directly or via the Front display module switchboard display unit. Four functional levels can be combined to adapt to all supervision requirements.

Communication components and connections

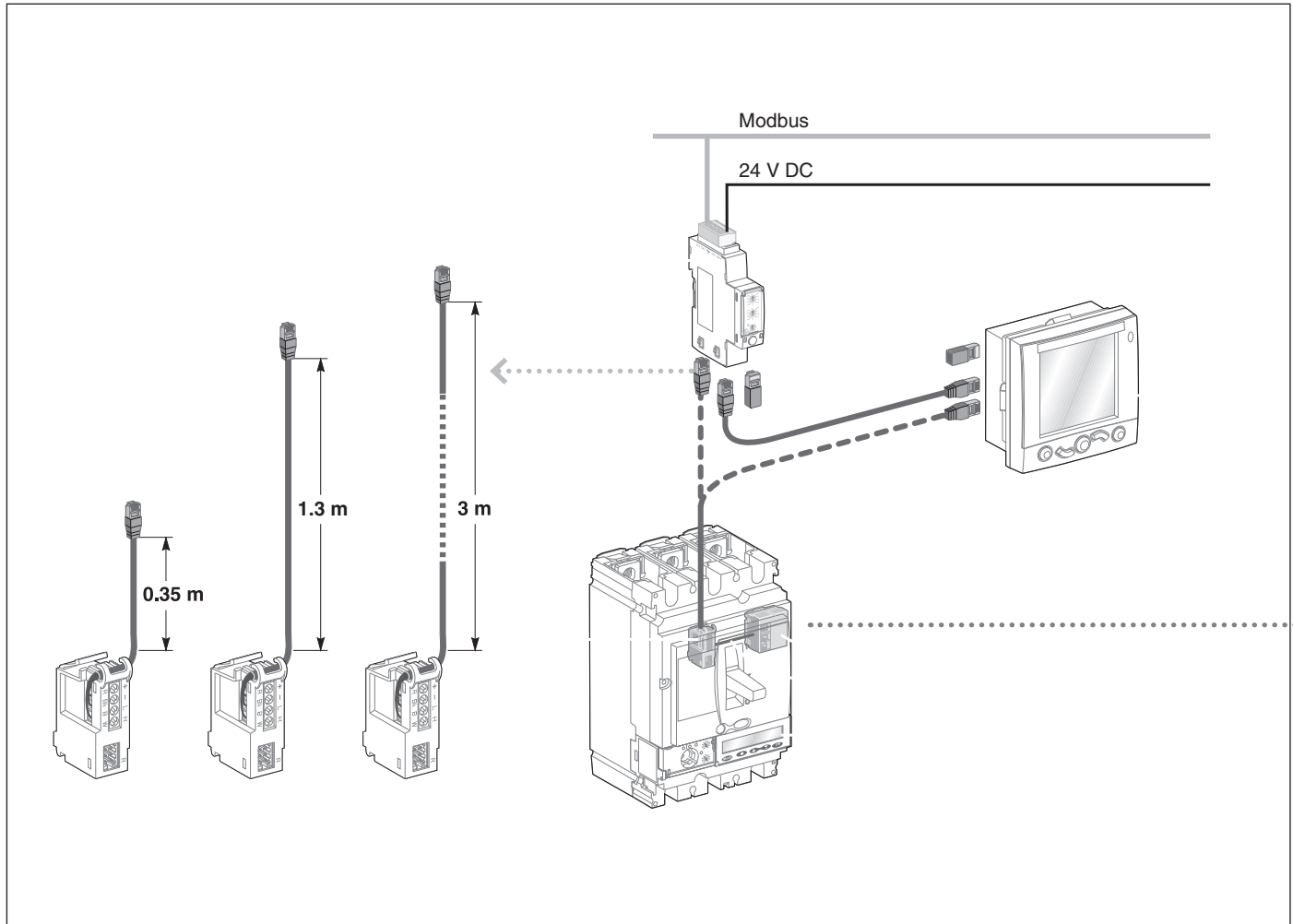

Modbus interface module

Functions

This module, required for connection to the network, contains the Modbus address (1 to 99) declared by the user via the two dials in front. It automatically adapts (baud rate, parity) to the Modbus network in which it is installed.

It is equipped with a lock-out switch to enable or disable operations involving writing to Control unit, i.e. reset, counter reset, setting modifications, device opening and closing commands, etc.

There is a built-in test function to check the connections of the Modbus interface module with the Control unit and Front display module.

Mounting

The module is mounted on a DIN rail. A number of modules may be clipped one next to the other.

For this, a stacking accessory is available for fast clip-connection of both the Modbus link and the 24 V DC supply. The Modbus interface module supplies 24 V DC to the corresponding Control unit, Front display module and BSCM module. Module consumption is 60 mA / 24 V DC.

BSCM module

Functions

The optional BSCM Breaker Status & Control Module is used to acquire device status indications and control the communicating remote-control function.

It includes a memory used to manage the maintenance indicators.

Status indications

Indication of device status: O/F, SD and SDE.

Maintenance indicators

The BSCM module manages the following indicators:

- mechanical operation counter
- electrical operation counter
- history of status indications.

It is possible to assign an alarm to the operation counters.

Controls

The module can be used to carry out communicating remote control operations: (open, close and reset) in different modes (manual, auto).

Mounting

The BSCM module can be installed on all BX circuit breakers and switch-disconnectors. It simply clips into the auxiliary contact slots. It occupies the slots of one O/F contact and one SDE contact. The BSCM is supplied with 24 V DC power automatically via the BX cord when the communication system is installed.

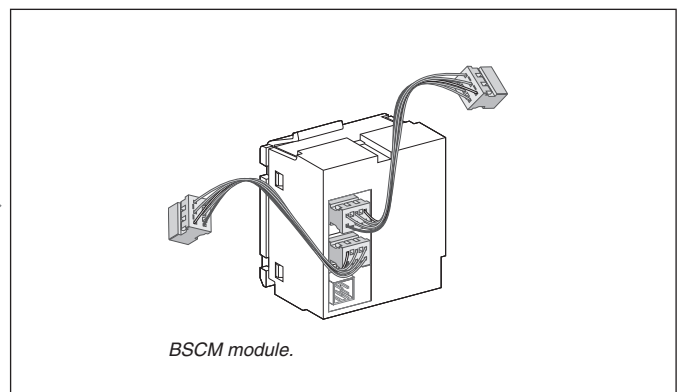

Molded Case Circuit Breakers BX series (100AF to 630AF) Communication

■ Networks

Modbus

Modbus is the most widely used communication protocol in industrial networks.

It operates in master-slave mode. The devices (slaves) communicate one after the other with a gateway (master). DW and BX products all operate with this protocol. A Modbus network is generally implemented on an LV or MV switchboard scale.

Depending on the data monitored and the desired refresh rate, a Modbus network connected to a gateway can serve 4 to 16 devices. For larger installations, a number of Modbus networks can be connected to an Ethernet network (TCP/IP/Modbus) via their gateways.

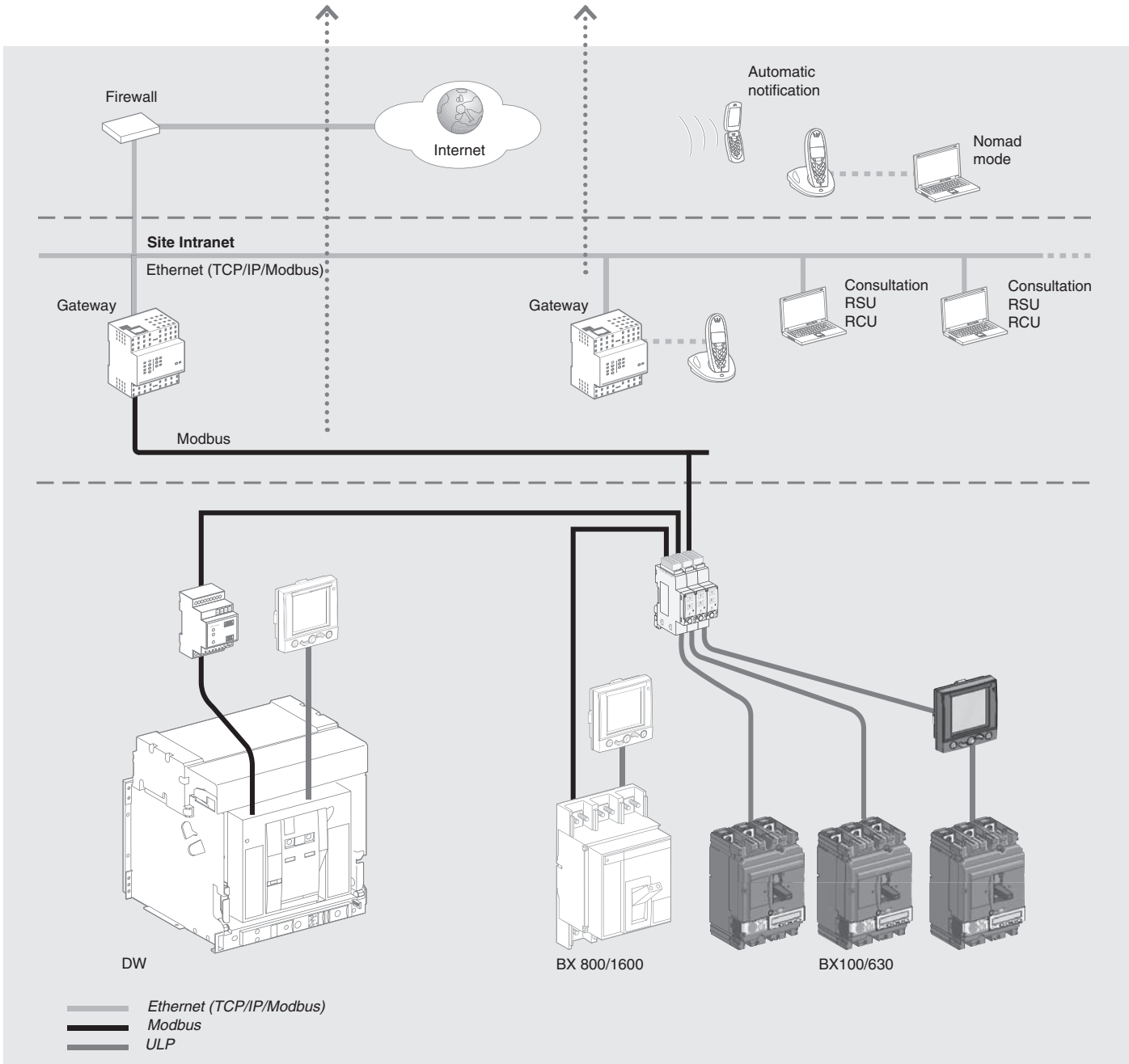

Molded Case Circuit Breakers BX series (100AF to 630AF) Accessories for Control units

■ BX cord

- For voltage $U \leq 480$ V, available in 3 prefabricated lengths: 0.35 m, 1.3 m and 3 m.
- For voltages $U > 480$ V, a special 1.3 m cord with an insulation accessory is required.
- A set of cords with RJ45 connectors is available to adapt to different distances between devices.

Configuration and maintenance module

Included in the maintenance kit, this module tests Control unit operation and provides access to all parameters and settings. It connects to the Control unit test connector and can operate in two modes.

■ Stand-alone mode to:

- supply the Control unit and check operation via the Ready LED
- check mechanical operation of the circuit breaker (trip using pushbutton).

■ PC mode, connected to a PC via USB or Bluetooth link.

This mode provides access to protection settings, alarm settings and readings of all indicators. Using the associated RSU software utility, it is possible to store, in a dedicated file for each device, all the data that can be transferred to another device.

This mode also offers operating-test functions:

- check on trip time delay (trip curve)
- check on non-tripping time (discrimination)
- check on ZSI (Zone Selective Interlocking) function
- alarm simulation
- display of setting curves
- display of currents
- printing of test reports.



BX cord U > 480 V

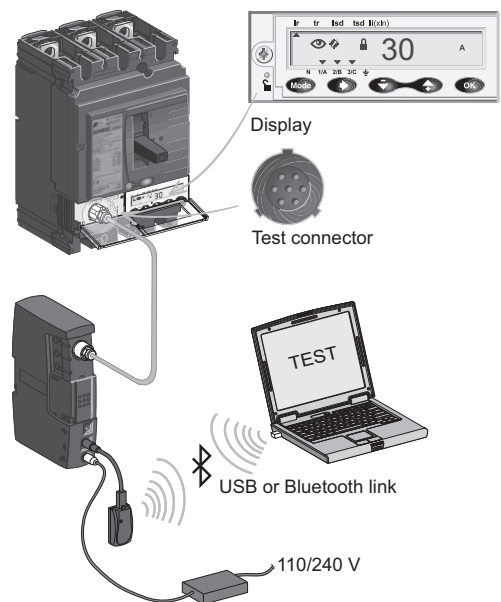

Using the configuration and maintenance module.

Molded Case Circuit Breakers BX series (100AF to 630AF) Accessories and auxiliaries

■ Overview of BX100 to 630 fixed version

Insulation accessories ▶ page 38

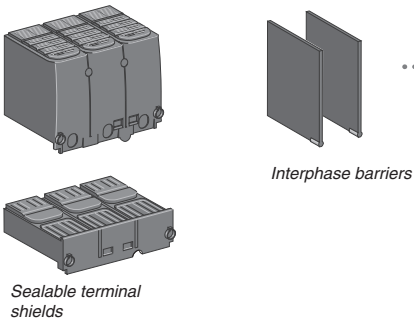

Connection ▶ page 35

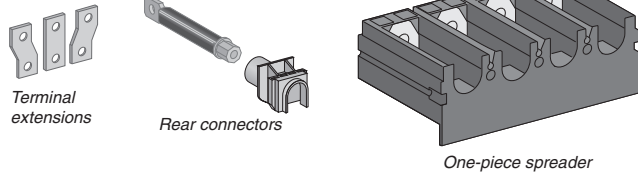

Electrical auxiliaries

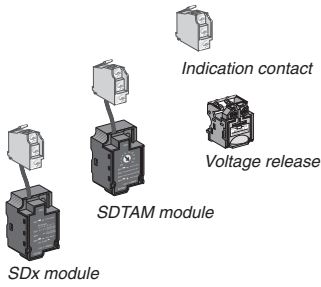

Communication and display ▶ page 28

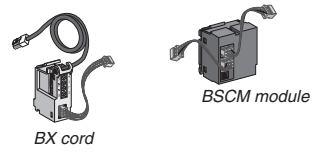

Protection and measurements

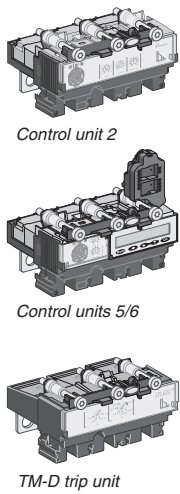

Control accessories ▶ page 44

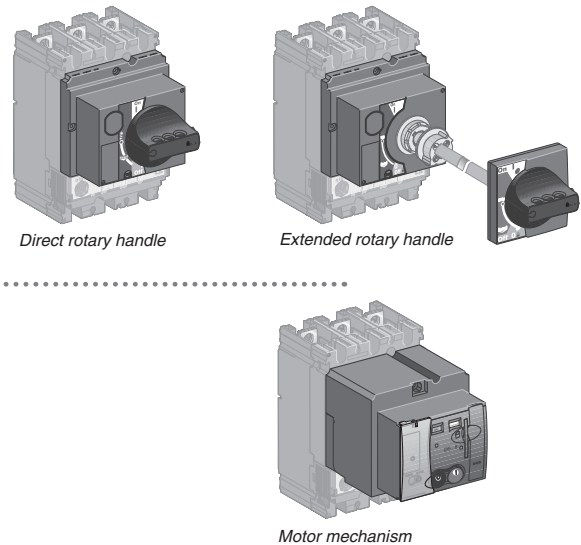

■ Overview of BX100 to 630 plug-in versions

Insulation accessories ► page 38

Connection ► page 35 and page 37

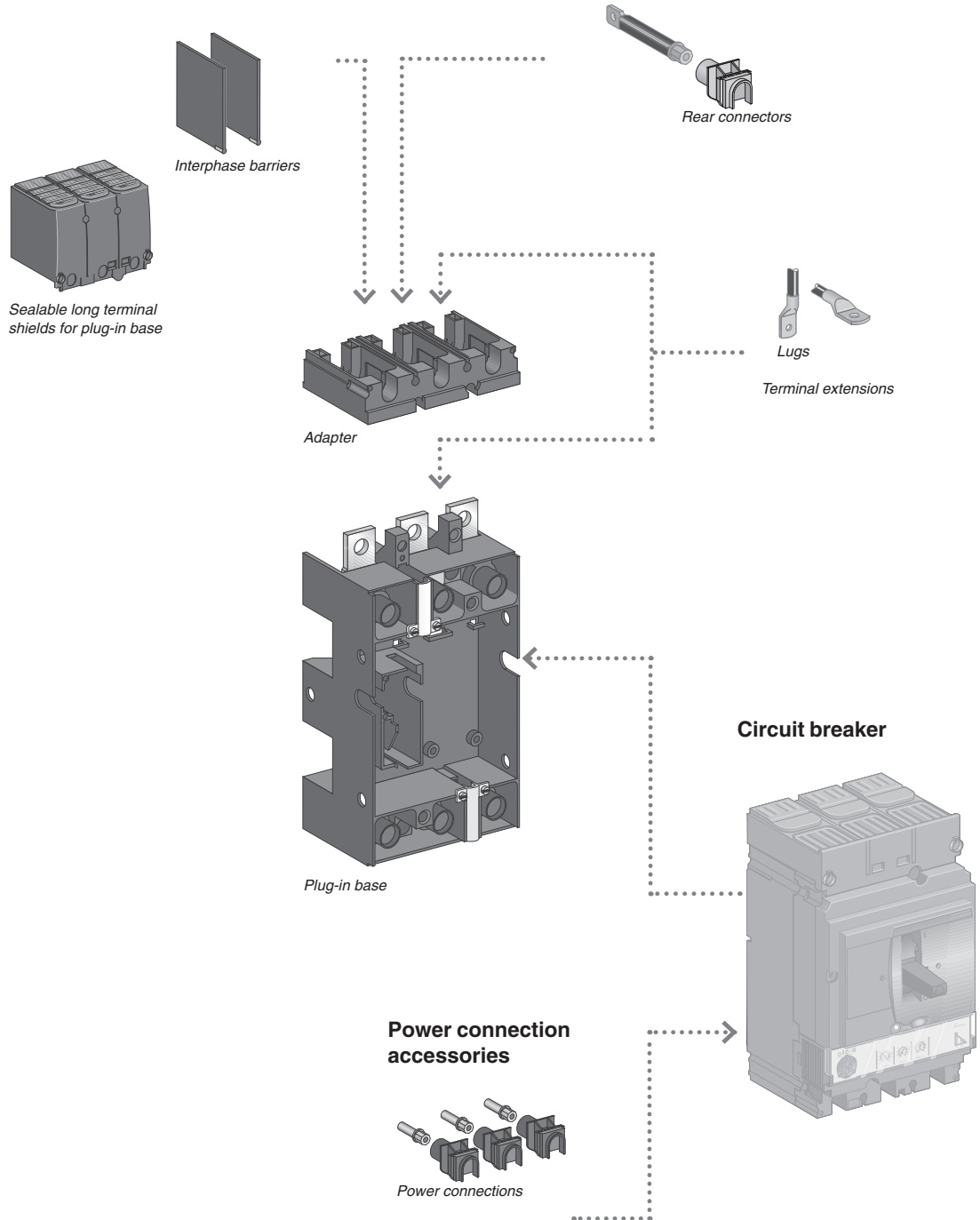

Molded Case Circuit Breakers

BX series (100AF to 630AF)

Accessories and auxiliaries

■ Device installation

Fixed circuit breakers

Fixed circuit breakers are designed for standard connection using bars or cables with lugs. Bare-cable connectors are available for connection to bare copper or aluminium cables. For connection of large cables, a number of solutions with spreaders may be used for both cables with lugs or bare cables.

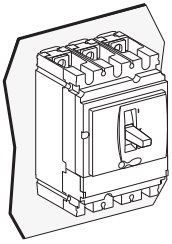

Mounting on a backplate.

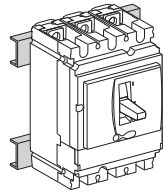

Mounting on rails.

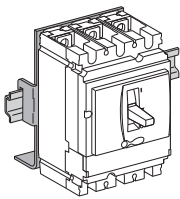

Mounting on DIN rail (with adapter).

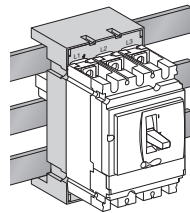

Mounting on busbars with an adapter.

Plug-in circuit breakers

The plug-in version makes it possible to:

- extract and/or rapidly replace the circuit breaker without having to touch the connections on the base
- allow for the addition of future circuits by installing bases that will be equipped with a circuit breaker at a later date
- isolate the power circuits when the device is mounted on or through a panel. It acts as a barrier for the connections of the plug-in base. Insulation is made complete by the mandatory short terminal shields on the device. The degrees of protection are:

- circuit breaker plugged in = IP4
- circuit breaker removed = IP2
- circuit breaker removed, base equipped with shutters = IP4.

Parts of a plug-in configuration

A plug-in configuration is made by adding a "plug-in kit" to a fixed device.

To avoid connecting or disconnecting the power circuits under load conditions, a safety trip causes automatic tripping if the device is ON, before engaging or withdrawing it. The safety trip, supplied with the kit, must be installed on the device. If the device is disconnected, the safety trip does not operate. The device can be operated outside the switchboard.

Accessories

Optional insulation accessories are available.

- Terminal shields to protect against direct contact.
- Interphase barriers to reinforce insulation between phases and protect against direct contact.

Mounting

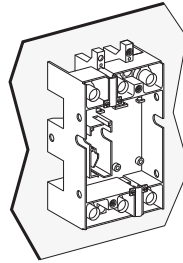

Mounting on a backplate.

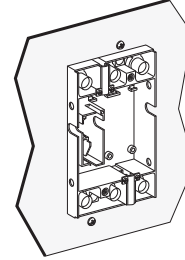

Mounting through a front panel.

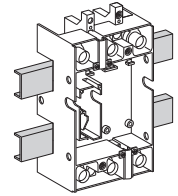

Mounting on rails.

BX circuit breakers may be installed horizontally, vertically or flat on their back, without derating performance levels.

There are three installation versions:

- fixed
- plug-in (on a base)
- withdrawable (on a chassis).

For the last two, components must be added (base, chassis) to the fixed version.

Many connection components are shared by the three versions.



Fixed BX250

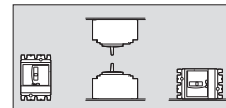

Installation positions.

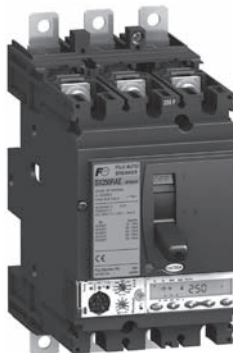

Plug-in BX250

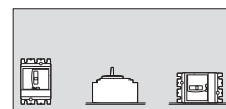

Installation positions.

Molded Case Circuit Breakers BX series (100AF to 630AF) Accessories and auxiliaries

■ Connection of fixed devices

Front connection

• Bars or cables with lugs

Standard terminals

BX100 to 630 come with terminals comprising snap-in nuts with screws:

- BX: M6 nuts and screws. BX160/250: M8 nuts and screws
- BX400/630: M10 nuts and screws.

These terminals may be used for:

- direct connection of insulated bars or cables with lugs
- terminal extensions offering a wide range of connection possibilities.

Interphase barriers or terminal shields are recommended. They are mandatory for certain connection accessories (in which case the interphase barriers are provided).

Bars

When the switchboard configuration has not been tested, insulated bars are mandatory.

Maximum size of bars

BX circuit breaker		100/160/250	400/630
Without spreaders	pitch (mm)	35	45
	maximum bar size (mm)	20 x 2	32 x 6
With spreaders	pitch (mm)	-	52.5
	maximum bar size (mm)	-	40 x 6

Crimp lugs

There are two models, for aluminium and copper cables.

It is necessary to use narrow lugs, compatible with device connections. They must be used with interphase barriers or long terminal shields. The lugs are supplied with interphase barriers and may be used for the types of cables listed below. Cable sizes for connection using lugs

BX circuit breaker		100/160/250	400/630
Copper cables	size (mm ²)	120, 150, 185	240, 300
	crimping	hexagonal barrels or punching	
Aluminium cables	size (mm ²)	120, 150, 185	240, 300
	crimping	hexagonal barrels	

Spreaders

Spreaders may be used to increase the pitch:

- BX400/630: the 45 mm pitch can be increased to 52 or 70 mm.

Bars, cable lugs or cable connectors can be attached to the ends.

Pitch (mm) depending on the type of spreader

BX circuit breaker	BX100/160/250	BX400/630
Without spreaders	35	45
With spreaders	-	52.5 or 70

Fixed circuit breakers are designed for standard front connection using bars or cables with lugs.

Cable connectors are available for bare cables. Rear connection is also possible.

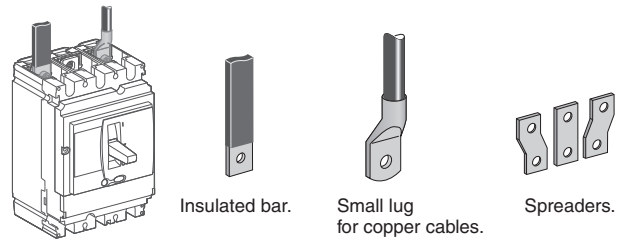

Molded Case Circuit Breakers

BX series (100AF to 630AF)

Accessories and auxiliaries

Maximum size of cables depending on the type of connector

BX circuit breaker		100/160	250	400	630
Steel connectors	1.5 to 95 mm ²	●			
Aluminium connectors	25 to 95 mm ²	●	●		
	120 to 185 mm ²	●	●		
	2 cables 50 to 120 mm ²	●	●		
	2 cables 35 to 240 mm ²			●	●
	35 to 300 mm ²			●	●
Distribution connectors	6 cables 35 mm ²	●	●		
Polybloc distribution blocks	6 or 9 cables 10/16 mm ²	●	●		

Rear connection

Device mounting on a backplate with suitable holes enables rear connection.

• Bars or cables with lugs

Rear connections for bars or cables with lugs are available in two lengths. Bars may be positioned flat, on edge or at 45° angles depending on how the rear connections are positioned.

The rear connections are simply fitted to the device connection terminals. All combinations of rear connection lengths and positions are possible on a given device.

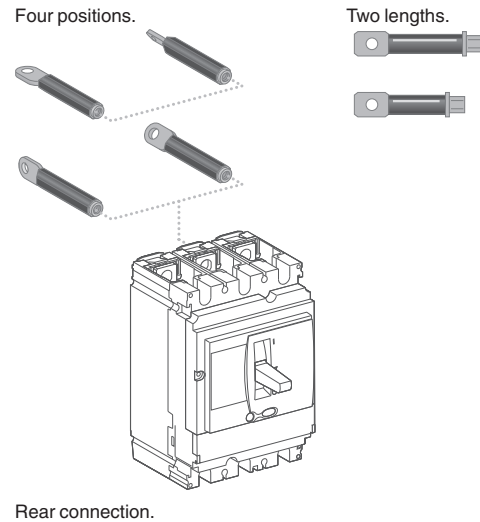

■ Connection of plug-in devices

Bars or cables with lugs

The plug-in base is equipped with terminals which, depending on their orientation, serve for front and rear connection.
For rear connection of a base mounted on a backplate, the terminals must be replaced by insulated, long right-angle terminal extensions. For BX630 devices, connection most often requires the 52.5 or 70 mm pitch spreaders.

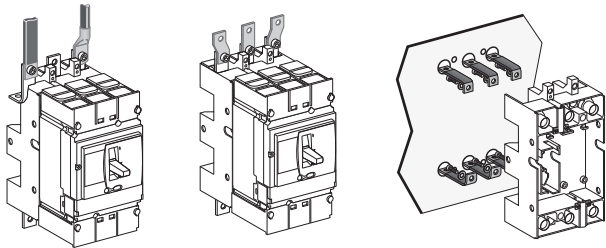

Front connection.

Front connection with spreaders.

Rear connection of a base mounted on a backplate.

Connection accessories

All accessories for fixed devices (bars, lugs, terminal extensions and spreaders) may be used with the plug-in base (see page 35 and page 36).

Connection is identical for plug-in versions. The same accessories as for fixed devices may be used.

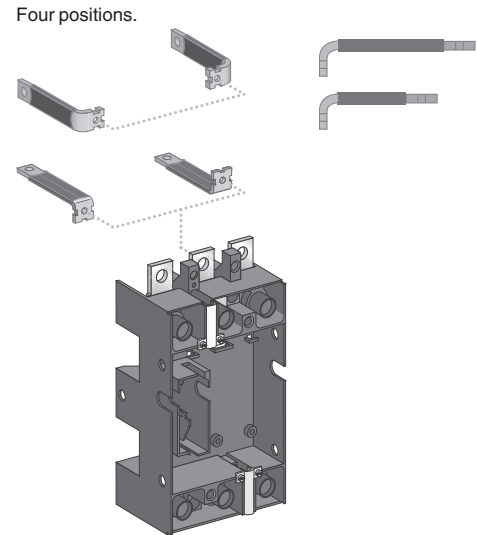

Adapter for plug-in base

The adapter is a plastic component for the 100 to 250 base and the 400/630 base that enables use of all the connection accessories of the fixed device.

It is required for interphase barriers and the long and short terminal shields.

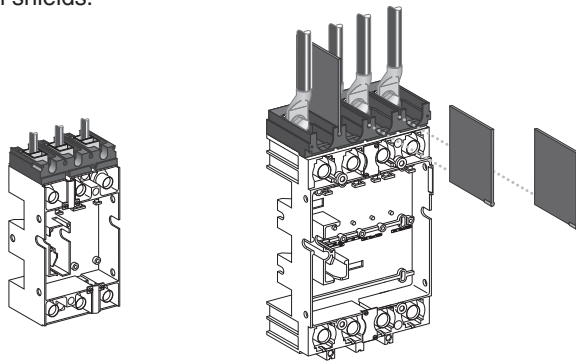

Adapter for 100 to 250 A - 3P base.
Connection with bars or cables with lugs.

Adapter for 400/630 A - 4P base.
Connection with spreaders and interphase barriers.

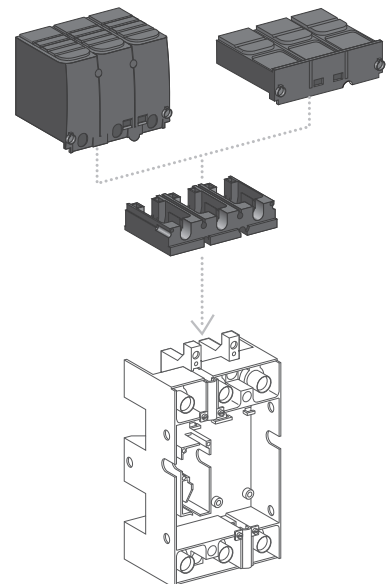

Molded Case Circuit Breakers

BX series (100AF to 630AF)

Accessories and auxiliaries

■ Insulation of live parts

Terminal shields

Insulating accessories used for protection against direct contact with power circuits. They provide IP40 degree of protection and IK07 mechanical impact protection.

• Terminal-shield types

BX100 to 250 and BX400/630 3P or 4P can be equipped with:

- short terminal shields
- long terminal shields.

All terminal shields have holes or knock-outs in front for voltage-presence indicators.

Short terminal shields

They are used with:

- plug-in and withdrawable versions in all connection configurations
- fixed versions with rear connection.

• Long terminal shields

They are used for front connection with cables or insulated bars. They comprise two parts assembled with captive screws, forming an IP40 cover.

- The top part is equipped with sliding grids with break marks for precise adaptation to cables or insulated bars.
- The rear part completely blocks off the connection zone. Partially cut squares can be removed to adapt to all types of connection for cables with lugs or copper bars.

Long terminal shields may be mounted upstream and downstream of:

- fixed devices
- the base of plug-in and withdrawable versions, thus completing the insulation provided by the mandatory short terminal shields on the device
- the one-piece spreader for BX100 to 250
- the 52.5 mm spreaders for BX400/630.

• Terminal shields and pitch

Combination possibilities are shown below.

Circuit breaker	BX100/160/250	BX400/630
Short terminal shields Pitch (mm)	35	45
Long terminal shields Pitch (mm)	35	45 52.5

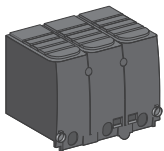

Long terminal shields.

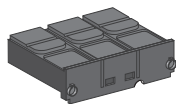

Short terminal shields.

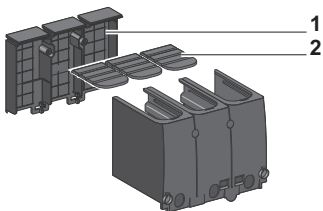

1 Partially cut removable squares.
2 Grids with break marks.

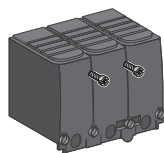

Assembled with captive screws.

Interphase barriers

Safety accessories for maximum insulation at the power-connection points:

- they clip easily onto the circuit breaker
- single version for fixed devices and adapters on plug-in bases
- not compatible with terminal shields
- the adapter for the plug-in base is required for mounting on plug-in and withdrawable versions.

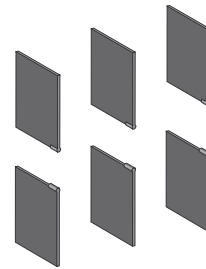

Rear insulating screens

Safety accessories providing insulation at the rear of the device.

Their use is mandatory for devices with spreaders, installed on backplates, when terminal shields are not used.

The available screen dimensions are shown below.

Circuit breaker	BX100/160/250	BX400/630
3P W x H x thickness (mm)	140 x 105 x 1	203 x 175 x 1.5
4P W x H x thickness (mm)	175 x 105 x 1	275 x 175 x 1.5

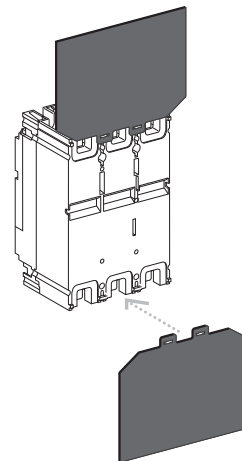

Connection is identical for both withdrawable and plug-in versions. The same accessories as for fixed devices may be used.

■ Selection of auxiliaries for BX100/160/250

Standard

All BX100/160/250 circuit breakers and switch-disconnectors have slots for the electrical auxiliaries listed below.

- **5 indication contacts** (see page 43)
 - 2 ON/OFF (OF1 and OF2)
 - 1 trip indication (SD)
 - 1 fault-trip indication (SDE)
- **1 remote-tripping release** (see page 45)
 - either 1 MN undervoltage release
 - or 1 MX shunt release.

Remote indications

Circuit breakers equipped with Control unit trip units may be equipped with a fault-trip indication to identify the type of fault by installing:

- **1 indication module with two outputs** (see page 43)
 - either an SDx module with unit 2/5A or E/6A or E

This module occupies the slots of one OF contact and an MN/MX release.

All these auxiliaries may be installed with a motor mechanism or a rotary handle or a toggle handle.

The following table indicates auxiliary possibilities depending on the type of trip unit.

TM-D trip unit

- Standard

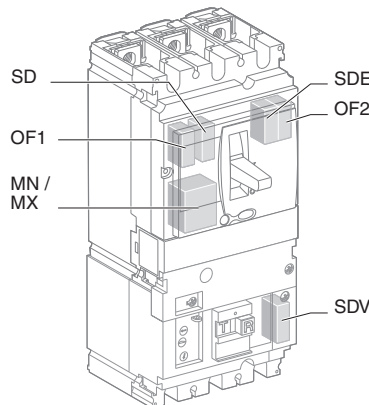
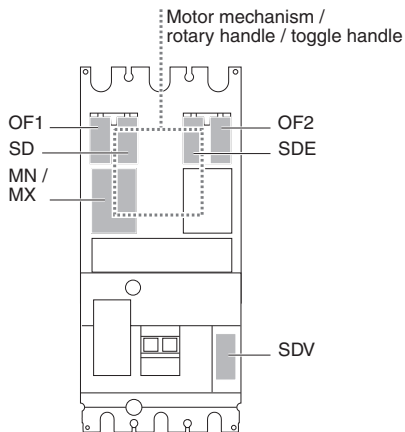

Control units 2 / 5 / 6

- Standard

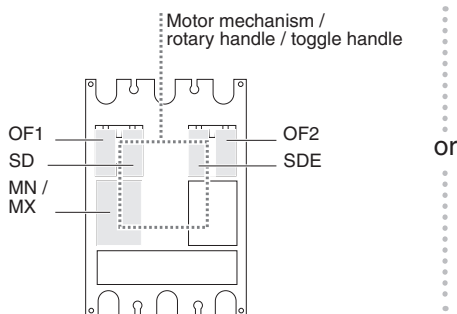

- Remote indications via SDx

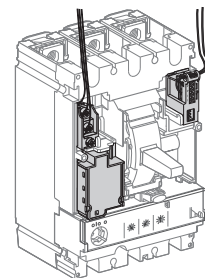
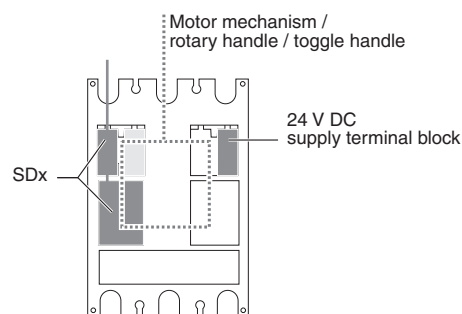

The SDx uses the OF1 and MN/MX slots. External connection is made via a terminal block in the OF1 slot. The 24 V DC supply provides for the Control unit 5 / 6 display when the device is OFF or under low-load conditions.

Molded Case Circuit Breakers BX series (100AF to 630AF) Accessories and auxiliaries

Communication

Communication requires specific auxiliaries (see page 28).

• Communication of status indications

- 1 BSCM module.
 - 1 BX cord (internal terminal block) for both communication and 24 V DC supply to the BSCM.
- Communication of status conditions is compatible with a toggle handle and a rotary handle.

• Communication of status indications and controls

- This requires, in addition to the previous auxiliaries:
- 1 communicating motor mechanism connected to the BSCM.

• Communication of measurements

- Available on unit 5 / 6, the system consists of:
- 1 BX cord (internal terminal block) for both communication and 24 V DC supply to the Control unit.
- Communication of measurements is compatible with a standard or communicating motor mechanism and a rotary handle.

• Communication of status indications, controls and measurements

- Available on unit 5 / 6, the system consists of:
- 1 BSCM module
 - 1 BX cord (internal terminal block) for both communication and 24 V DC supply to the BSCM and the Control unit
 - 1 communicating motor mechanism connected to the BSCM.

• Installation of SDx is compatible with communication.

The following table indicates auxiliary possibilities depending on the type of trip unit.

TM-D trip unit, Control unit 2

• Communication of status indications

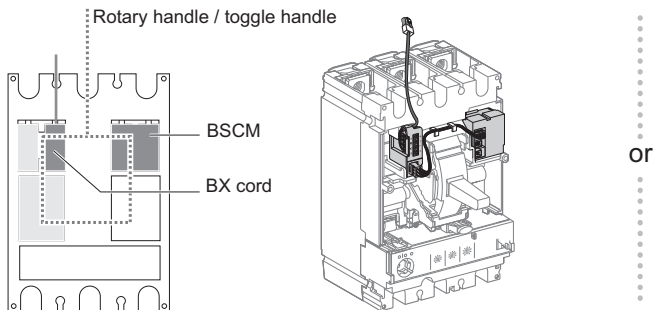

• Communication of status indications and controls

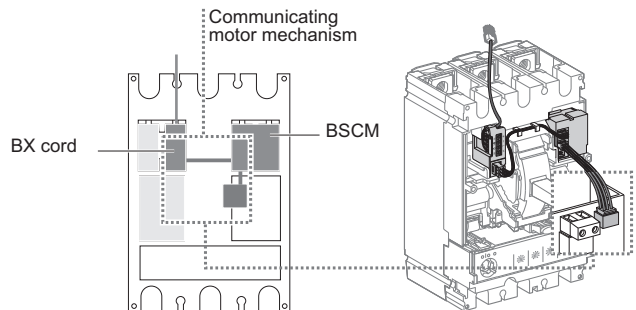

Control units 5/6

• Communication of measurements

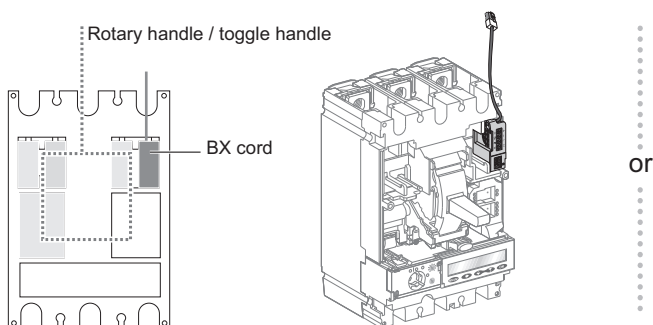

• Communication of status indications, controls and measurements

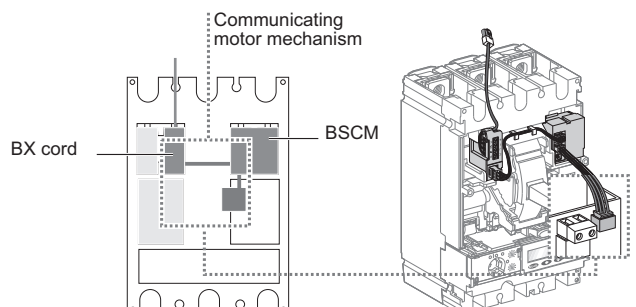

Molded Case Circuit Breakers BX series (100AF to 630AF) Accessories and auxiliaries

■ Selection of auxiliaries for BX400/630

Standard

All BX400/630 circuit breakers and switch-disconnectors have slots for the electrical auxiliaries listed below.

- **7 indication contacts** (see page 43)
 - 4 ON/OFF (OF1, OF2, OF3, OF4)
 - 1 trip indication (SD)
 - 1 fault-trip indication (SDE)
- **1 remote-tripping release** (see page 45)
 - either 1 MN undervoltage release
 - or 1 MX shunt release.

Remote indications

Circuit breakers equipped with Control unit trip units may be equipped with a fault-trip indication to identify the type of fault by installing:

- **1 indication module with two outputs** (see page 43)
 - either an SDx module with Control units 2/5A or E/6A or E
 This module occupies the slots of an MN/MX release.

All these auxiliaries may be installed with a motor mechanism or a rotary handle or a toggle handle.
The following table indicates auxiliary possibilities depending on the type of trip unit.

Control units 2 / 5 / 6

• Standard

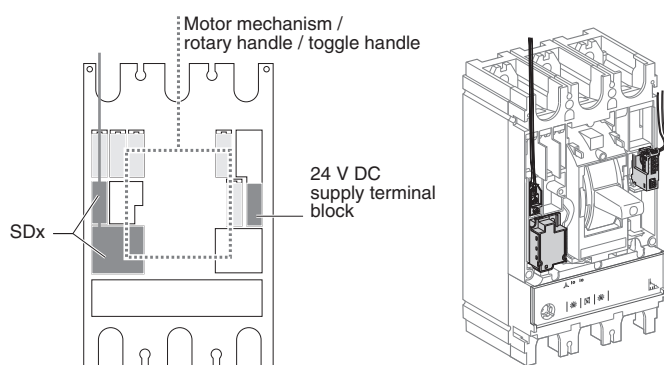
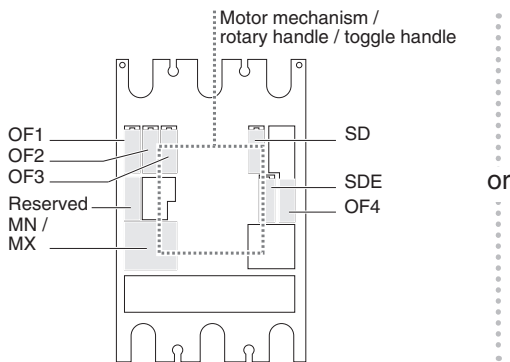

The SDx uses the reserved slot and the MN/MX slots.
External connection is made via a terminal block in the reserved slot.
The 24 V DC supply provides for the units 5 / 6 display when the device is OFF or under low-load conditions.

Molded Case Circuit Breakers

BX series (100AF to 630AF)

Accessories and auxiliaries

Communication

Communication requires specific auxiliaries (see page 28).

• Communication of status indications

- 1 BSCM module
 - 1 BX cord (internal terminal block) for both communication and 24 V DC supply to the BSCM.
- Communication of status conditions is compatible with a toggle handle and a rotary handle.

• Communication of status indications and controls

- This requires, in addition to the previous auxiliaries:
- 1 communicating motor mechanism connected to the BSCM.

• Communication of measurements

- Available on units 5 / 6, the system consists of:
- 1 BX cord (internal terminal block) for both communication and 24 V DC supply to the Control unit.
- Communication of measurements is compatible with a standard or communicating motor mechanism and a rotary handle.

• Communication of status indications, controls and measurements

- Available on units 5 / 6, the system consists of:
- 1 BSCM module
 - 1 BX cord (internal terminal block) for both communication and 24 V DC supply to the BSCM and the Control unit
 - 1 communicating motor mechanism connected to the BSCM.

Installation of SDx is compatible with communication. The following table indicates auxiliary possibilities depending on the type of trip unit.

Control unit 2

• Communication of status indications

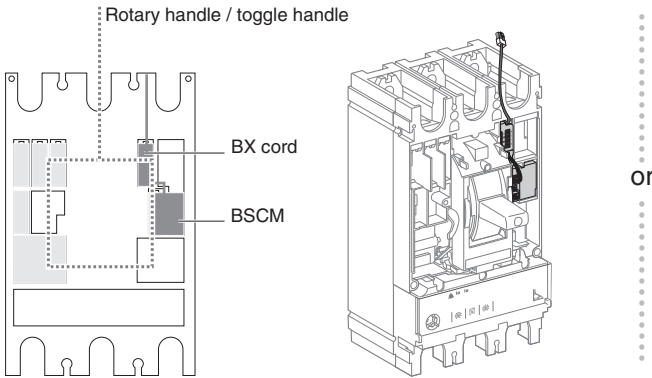

• Communication of status indications and controls

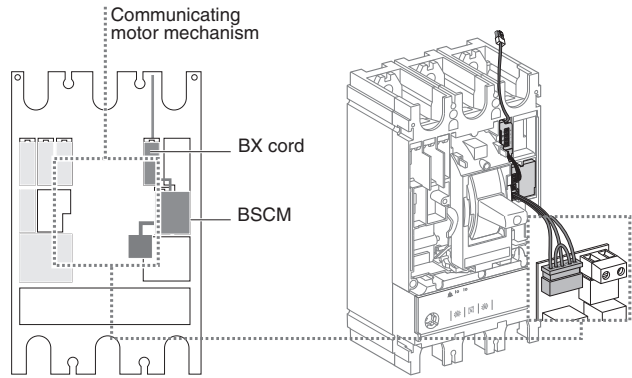

Control units 5 / 6

• Communication of status indications

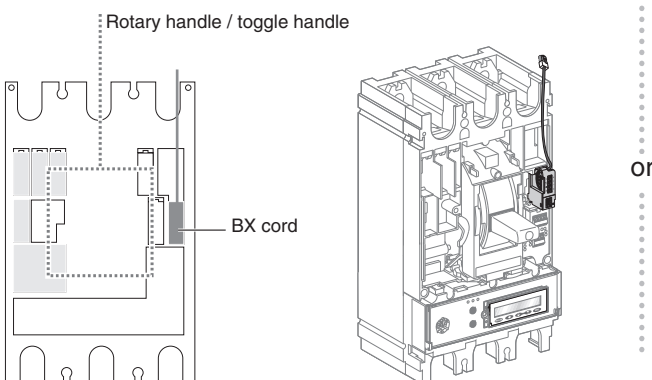

• Communication of status indications, controls and measurements with or without FDM121 display

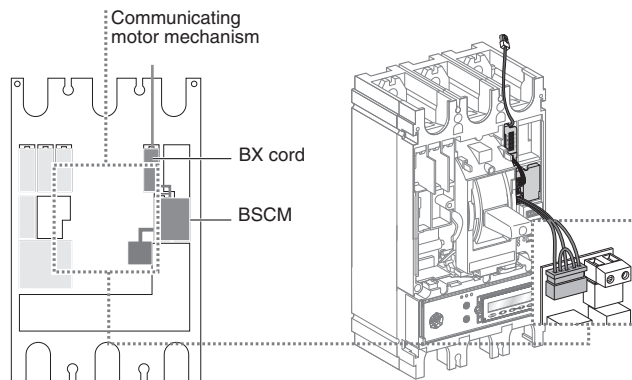

■ Indication contacts

These common-point changeover contacts provide remote circuit-breaker status information. They can be used for indications, electrical locking, relaying, etc. They comply with the IEC 60947-5 international recommendation.



Indication contacts

Functions

• Breaker-status indications, during normal operation or after a fault

A single type of contact provides all the different indication functions:

- OF (ON/OFF) indicates the position of the circuit breaker contacts
- SD (trip indication) indicates that the circuit breaker has tripped due to:
 - an overload
 - a short-circuit
 - a ground fault (unit 6)
 - operation of a voltage release
 - operation of the "push to trip" button
 - disconnection when the device is ON.

The SD contact returns to de-energised state when the circuit breaker is reset.

- SDE (fault-trip indication) indicates that the circuit breaker has tripped due to:
 - an overload
 - a short-circuit
 - a ground fault (unit 6).

The SD contact returns to de-energised state when the circuit breaker is reset.

All the above auxiliary contacts are also available in "low-level" versions capable of switching very low loads (e.g. for the control of PLCs or electronic circuits).

Installation

- OF,SD and SDE functions: a single type of contact provides all these different indication functions, depending on where it is inserted in the device. The contacts clip into slots behind the front cover of the circuit breaker.

The SDE function on a BX100 - 250 A equipped with a magnetic, thermal-magnetic or Control unit 2 requires the SDE actuator.

■ SDx modules for Control unit

SDx module

The SDx module remotes the trip or alarm conditions of BX circuit breakers equipped with electronic protection. The SD2 output, available on all Control units, corresponds to the overload-trip indication.

The SD4 output, available on unit 5 / 6, is assigned to:

- overload pre-alarm (unit 5)
- ground-fault trip indication (unit 6).

These two outputs automatically reset when the device is closed (turned ON).

For Control units 5 / 6, the SD2 and SD4 outputs can be reprogrammed to be assigned to other types of tripping or alarm.

• Output characteristics

It is possible to assign a function:

- latching with a time delay. Return to the initial state occurs at the end of the time delay
- permanent latching. In this case, return to the initial state takes place via the communication function.

Static outputs: 24 to 415 V AC / V DC; 80 mA max.

SDE is relay modules with two static outputs. They send different signals depending on the type of fault. They may not be used together.



SDx relay module with its terminal block.

Electrical characteristics of auxiliary contacts

Contacts		Standard				Low level			
Types of contacts		All				OF, SD, SDE			
Rated thermal current (A)		6				5			
Minimum load		100 mA at 24 V DC				1 mA at 4 V DC			
Utilisation cat. (IEC 60947-5-1)		AC12	AC15	DC12	DC14	AC12	AC15	DC12	DC14
Operational current (A)	24V AC/DC	6	6	6	1	5	3	5	1
	48V AC/DC	6	6	2.5	0.2	5	3	2.5	0.2
	110V AC/DC	6	5	0.6	0.05	5	2.5	0.6	0.05
	220/240V AC	6	4	-	-	5	2	-	-
	250V DC	-	-	0.3	0.03	5	-	0.3	0.03
	380/440V AC	6	2	-	-	5	1.5	-	-
	480V AC	6	1.5	-	-	5	1	-	-
660/690V AC	6	0.1	-	-	-	-	-	-	

Molded Case Circuit Breakers

BX series (100AF to 630AF)

Accessories and auxiliaries

Motor mechanism

When equipped with a motor-mechanism module, BX circuit breakers feature very high mechanical endurance as well as easy and sure operation:

- all circuit-breaker indications and information remain visible and accessible, including trip-unit settings and indications
- suitability for isolation is maintained and padlocking remains possible
- double insulation of the front face.

A specific motor mechanism is required for operation via the communication function. This communicating motor mechanism must be connected to the BSCM module to receive the opening and closing orders. Operation is identical to that of a standard motor mechanism.

Applications

- Local motor-driven operation, centralised operation, automatic distribution control.
- Normal/standby source changeover or switching to a replacement source to ensure availability or optimise energy costs.
- Load shedding and reconnection.
- Synchrocoupling.

Operation

The type of operation is selected using the manual/auto mode selection switch (7).

A transparent, lead-seal cover controls access to the switch.

Automatic

When the switch is in the “auto” position, the ON/OFF (I/O) buttons and the charging lever on the mechanism are locked.

- Circuit-breaker ON and OFF controlled by two impulse-type or maintained signals.
- Automatic spring charging following voluntary tripping (by MN or MX), with standard wiring.
- Mandatory manual reset following tripping due to an electrical fault.

Manual

When the switch is in the “manual” position, the ON/OFF (I/O) buttons may be used. A microswitch linked to the manual position can remote the information.

- Circuit-breaker ON and OFF controlled by 2 pushbuttons I/O.
- Recharging of stored-energy system by pumping the lever 8 times.
- Padlocking in OFF position.

Installation and connections

All installation (fixed, plug-in/withdrawable) and connection possibilities are maintained.

Motor-mechanism module connections are made behind its front cover to integrated terminals, for cables up to 2.5 mm².

Optional accessories

- Keylock for locking in OFF position.
- Operations counter for the BX400/630, indicating the number of ON/OFF cycles. Must be installed on the front of the motor-mechanism module.



BX with motor mechanism.

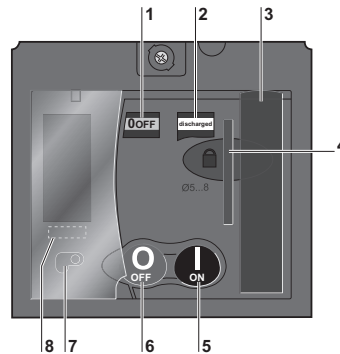

- 1 Position indicator (positive contact indication)
- 2 Spring status indicator (charged, discharged)
- 3 Manual spring-charging lever
- 4 Keylock device (optional)
Locking device (OFF position), using 1 to 3 padlocks, shackle diameter 5 to 8 mm, not supplied
- 5 I (ON) pushbutton
- 6 O (OFF) pushbutton
- 7 Manual/auto mode selection switch. The position of this switch can be indicated remotely.
- 8 Operation counter (BX400/630)

Characteristics

Motor mechanism		MT100 to MT630	
Response time (ms)	opening	< 600	
	closing	< 80	
Operating frequency	cycles/minute max.	4	
Control voltage (V)	DC	24/30 - 48/60 - 110/130 - 250	
	AC 50/60 Hz	48 (50 Hz) - 110/130 - 220/240 - 380/440	
Consumption ⁽¹⁾	DC (W)	opening	≤ 500
		closing	≤ 500
	AC (VA)	opening	≤ 500
		closing	≤ 500

(1) For BX100 to BX250, the inrush current is 2 In for 10 ms.

Electrical endurance

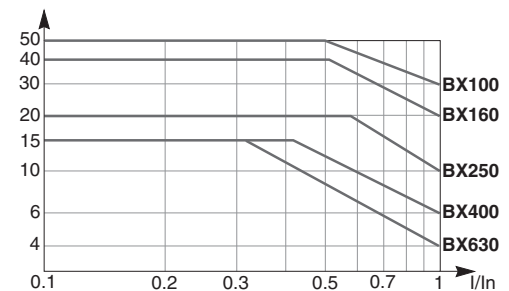

Circuit breaker + motor-mechanism module, in thousands of operations (IEC 60947 2), at 440 V.

■ Remote tripping

MX or MN voltage releases are used to trip the circuit breaker. They serve primarily for remote, emergency-off commands. It is advised to test the system every six months.

MN undervoltage release

The MN release opens the circuit breaker when its supply voltage drops to a value below 35 % of its rated voltage U_n . Undervoltage tripping, combined with an emergency-off button, provides fail-safe tripping. The MN release is continuously supplied, i.e. if supply is interrupted:

- either voluntarily, by the emergency-off button,
- or accidentally, through loss of power or faulty wiring, the release provokes opening of the circuit breaker.

• Opening conditions

Circuit-breaker tripping by an MN release meets the requirements of standard IEC 60947-2.

- Automatic opening of the circuit breaker is ensured when the continuous voltage supply to the release $U \leq 0.35 \times U_n$.
- If the supply voltage is between 0.35 and 0.7 U_n , opening is possible, but not guaranteed. Above 0.7 U_n , opening does not take place.

• Closing conditions

If there is no supply to the MN release, it is impossible to close the circuit breaker, either manually or electrically. Closing is ensured when the voltage supply to the release $U \geq 0.85 \times U_n$. Below this threshold, closing is not guaranteed.

• Characteristics

Power supply	V AC	50/60 Hz: 24 - 48 - 100/130 - 200/240 50 Hz: 380/415 60 Hz: 208/277
	V DC	12 - 24 - 30 - 48 - 60 - 125 -250
Operating threshold	Opening	0.35 to 0.7 U_n
	Closing	0.85 U_n
Operating range		0.85 to 1.1 U_n
Consumption (VA or W)		Pick-up: 10 - Hold: 5
Response time (ms)		50

• Time-delay unit for an MN release

A time delay unit for the MN release eliminates the risk of nuisance tripping due to a transient voltage dip lasting ≤ 200 ms. For shorter micro-outages, a system of capacitors provides temporary supply to the MN at $U > 0.7$ to ensure non tripping.

The correspondence between MN releases and time-delay units is shown below.

Power supply	Corresponding MN release
Unit with fixed delay 200 ms	
48 V AC	48 V DC
220 / 240 V AC	250 V DC
Unit with adjustable delay ≤ 200 ms	
48 - 60 V AC/DC	48 V DC
100 - 130 V AC/DC	125 V DC
220 - 250 V AC/DC	250 V DC

MX shunt release

The MX release opens the circuit breaker via an impulse-type (≥ 20 ms) or maintained order.

• Opening conditions

When the MX release is supplied, it automatically opens the circuit breaker. Opening is ensured for a voltage $U \geq 0.7 \times U_n$.

• Characteristics

Power supply	V AC	50/60 Hz: 24 - 48 - 100/130 - 200/240 50 Hz: 380/415, 60 Hz: 208/277
	V DC	12 - 24 - 30 - 48 - 60 - 125 -250
Operating range		0.7 to 1.1 U_n
Consumption (VA or W)		Pick-up: 10
Response time (ms)		50

Circuit breaker control by MN or MX

When the circuit breaker has been tripped by an MN or MX release, it must be reset before it can be reclosed. MN or MX tripping takes priority over manual closing. In the presence of a standing trip order, closing of the contacts, even temporary, is not possible. Connection using wires up to 1.5 mm² to integrated terminal blocks.



MX or MN voltage release.

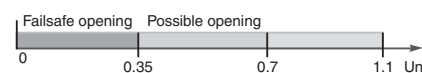

Opening conditions of the MN release.

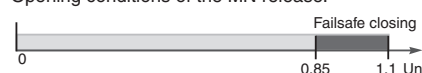

Closing conditions of the MN release.



MN voltage release.

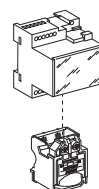

MN release with a time-delay unit.

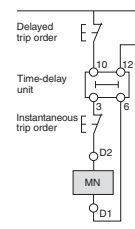

Wiring diagram for emergency-off function with MN + time-delay unit.



Opening conditions of the MX release.

Note: circuit breaker opening using an MN or MX release must be reserved for safety functions. This type of tripping increases wear on the opening mechanism. Repeated use reduces the mechanical endurance of the circuit breaker by 50 %.

Molded Case Circuit Breakers

BX series (100AF to 630AF)

Accessories and auxiliaries

■ Rotary handles

Direct rotary handle

• Standard handle

Degree of protection IP40, IK07.

The direct rotary handle maintains:

- visibility of and access to trip-unit settings
- suitability for isolation
- indication of the three positions O (OFF), I (ON) and tripped
- access to the "push to trip" button.

Device locking

The rotary handle facilitates circuit-breaker locking.

■ Padlocking:

- standard situation, in the OFF position, using 1 to 3 padlocks, shackle diameter 5 to 8 mm, not supplied
- with a simple modification, in the ON and OFF positions. Locking in the ON position does not prevent free circuit-breaker tripping if a fault occurs. In this case, the handle remains the ON position after the circuit breaker tripping. Unlocking is required to go to the tripped then the OFF position.

Early-make or early-break contacts (optional)

Early-make and/or early-break contacts may be used with the rotary handle. It is thus possible to:

- supply an MN undervoltage release before the circuit breaker closes
- open the contactor control circuit before the circuit breaker opens.

• MCC switchboard control

Control of an MCC switchboard is achieved by adding a kit to the standard handle. In addition to the standard functions, the kit offers the characteristics listed below.

Higher degree of protection IP

Degree of protection IP43, IK07.

The IP is increased by a built-in gasket.

Door locking depending on device position

- The door cannot be opened if the circuit breaker is ON or in the tripped position. For exceptional situations, door locking can be temporarily disabled with a tool to open the door when the circuit breaker is closed. This operation is not possible if the handle is locked by a padlock.
- Circuit-breaker closing is disabled if the door is open. This function can be deactivated.

Extended rotary handle

Degree of protection IP56, IK08.

The extended rotary handle makes it possible to operate circuit breakers installed at the back of switchboards, from the switchboard front.

It maintains:

- visibility of and access to trip-unit settings
- suitability for isolation
- indication of the three positions O (OFF), I (ON) and tripped.

Mechanical door locking when device closed

A standard feature of the extended rotary handle is a locking function, built into the shaft, that disables door opening when the circuit breaker is in the ON or tripped positions.

Door locking can be temporarily disabled with a tool to open the door without opening the circuit breaker. This operation is not possible if the handle is locked by a padlock.

Voluntary disabling of mechanical door locking

A modification to the handle, that can be carried out on site, completely disables door locking, including when a padlock is installed on the handle. The modification is reversible.

When a number of extended rotary handles are installed on a door, this disabling function is the means to ensure door locking by a single device.

There are two types of rotary handle:

- direct rotary handle
- extended rotary handle.

There are two models:

- standard with a black handle
- red handle and yellow front for machine-tool control.



BX with a rotary handle.



BX with an MCC rotary handle.



BX with a CNOMO machine-tool rotary handle.



BX with an extended rotary handle installed at the back of a switchboard, with the keylock option and key.

Extended rotary handle (cont.)

Device and door padlocking

Padlocking locks the circuit-breaker handle and disables door opening:

- standard situation, in the OFF position, using 1 to 3 padlocks, shackle diameter 5 to 8 mm, not supplied
- with a simple modification, in the ON and OFF positions. Locking in the ON position does not prevent free circuit-breaker tripping if a fault occurs.

In this case, the handle remains in the ON position after the circuit breaker tripping. Unlocking is required to go to the tripped then the OFF position.

If the door controls were modified to voluntarily disable door locking, padlocking does not lock the door, but does disable handle operation of the device.

Accessory for device operation with the door open

When the device is equipped with an extended rotary handle, a control accessory mounted on the shaft makes it possible to operate the device with the door open.

- The device can be padlocked in the OFF position.
- The accessory complies with UL508.

Early-make or early-break contacts (optional)

The extended rotary handle offers the same possibilities with early-make and/or early-break contacts as the standard rotary handle.

Parts of the extended rotary handles

- A unit that replaces the front cover of the circuit breaker (secured by screws).
- An assembly (handle and front plate) on the door that is always secured in the same position, whether the circuit breaker is installed vertically or horizontally.
- An extension shaft that must be adjusted to the distance. The min/max distance between the back of circuit breaker and door is:

- 185...600 mm for BX100 to 250
- 209...600 mm for BX400/630.

For withdrawable devices, the extended rotary handle is also available with a telescopic shaft to compensate for device disconnection. In this case, the min/max distances are:

- 248...600 mm for BX100 to 250
- 272...600 mm for BX400/630.

Molded Case Circuit Breakers BX series (100AF to 630AF) Operating conditions

■ Operating conditions

Altitude derating

Altitude does not significantly affect the characteristics of BX circuit breakers up to 2000 m. Above this altitude, it is necessary to take into account the decrease in the dielectric strength and cooling capacity of air.

The following table gives the corrections to be applied for altitudes above 2000 metres.

The breaking capacities remain unchanged.

BX100 to 630

Altitude (m)		2000	3000	4000	5000
Dielectric withstand voltage (V)		3000	2500	2100	1800
Insulation voltage (V)	Ui	800	700	600	500
Maximum operational voltage (V)	Ue	690	590	520	460
Average thermal current (A) at 40 °C	In x	1	0.96	0.93	0.9

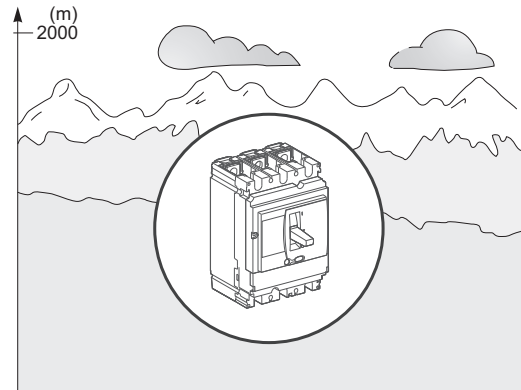

Vibrations

BX devices resist electromagnetic or mechanical vibrations. Tests are carried out in compliance with standard IEC 60068-2-6 for the levels required by merchant-marine inspection organisations (Veritas, Lloyd's, etc.):

- 2 to 13.2 Hz: amplitude ± 1 mm

- 13.2 to 100 Hz: constant acceleration 0.7 g.

Excessive vibration may cause tripping, breaks in connections or damage to mechanical parts.

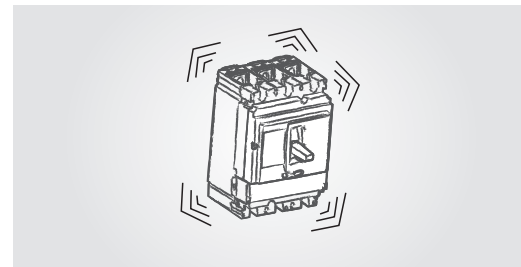

Degree of protection

BX circuit breakers have been tested for degree of protection (IP) mechanical impact protection (IK). See page 7.

Electromagnetic disturbances

BX devices are protected against:

- overvoltages caused by circuit switching

- overvoltages caused by an atmospheric disturbances or by a distribution-system outage (e.g. failure of a lighting system)

- devices emitting radio waves (radios, walkie-talkies, radar, etc.)

- electrostatic discharges produced directly by users.

BX devices have successfully passed the electromagnetic-compatibility tests (EMC) defined by the following international standards. See page 7.

These tests ensure that:

- no nuisance tripping occurs

- tripping times are respected.

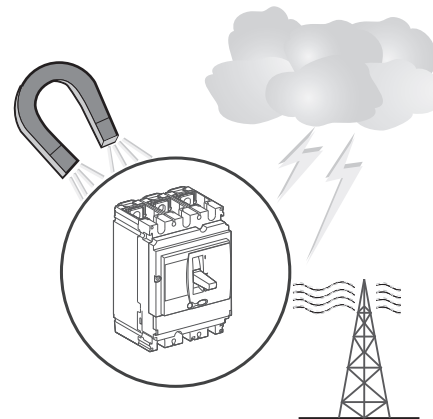

Molded Case Circuit Breakers BX series (100AF to 630AF) Installation in switchboards

■ Power supply and mass

Power supply from the top or bottom

BX circuit breakers can be supplied from either the top or the bottom, without any reduction in performance. This capability facilitates connection when installed in a switchboard.

All connection and insulation accessories can be used on circuit breakers supplied either from the top or bottom.

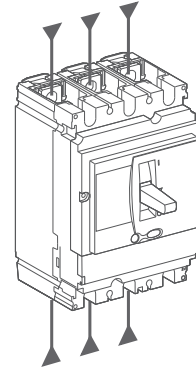

Mass

The table below presents the mass (in kg) of the circuit breakers and the main accessories, which must be summed to obtain the total mass of complete configurations. The values are valid for all performance categories.

Type of device		Circuit breakers	Base	Chassis	Motor mech.
BX100	3P/2D	1.79	0.8	2.2	1.2
	3P/3D	2.05	0.8	2.2	1.2
	4P/4D	2.4	1.05	2.2	1.2
BX160	3P/2D	1.85	0.8	2.2	1.2
	3P/3D	2.2	0.8	2.2	1.2
	4P/4D	2.58	1.05	2.2	1.2
BX250	3P/2D	1.94	0.8	2.2	1.2
	3P/3D	2.4	0.8	2.2	1.2
	4P/4D	2.78	1.05	2.2	1.2
BX400/630	3P/3D	6.19	2.4	2.2	2.8
	4P/4D	8.13	2.8	2.2	2.8

Molded Case Circuit Breakers BX series (100AF to 630AF) Installation in switchboards

■ Safety clearances and minimum distances

General rules

When installing a circuit breaker, minimum distances (safety clearances) must be maintained between the device and panels, bars and other protection devices installed nearby. These distances, which depend on the ultimate breaking capacity, are defined by tests carried out in accordance with standard IEC 60947-2.

If installation conformity is not checked by type tests, it is also necessary to:

- use insulated bars for circuit-breaker connections
- segregate the busbars using insulating screens.

For BX100 to 630 devices, terminal shields and interphase barriers are recommended and may be mandatory depending on the operating voltage of the device and type of installation (fixed, plug-in, etc.).









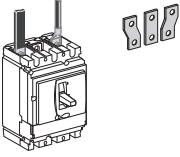
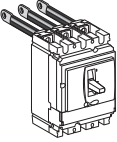
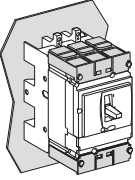
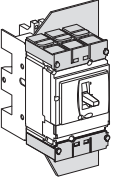

Power connections

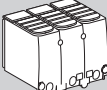
The table below indicates the rules to be respected for BX100 to 630 devices to ensure insulation of live parts for the various types of connection.

- fixed devices with front connection (FC) or rear connection (RC)
- plug-in devices.

Connection accessories such as crimp lugs, bare-cable connectors, terminal extensions (straight, right-angle, double-L and 45°) and spreaders are supplied with interphase barriers. Long terminal shields provide a degree of protection of IP40 (ingress) and IK07 (mechanical impact).

BX100 to 630: rules to be respected to ensure insulation of live parts

Type of connection			Fixed, front connection			Fixed, rear connection	Plug-in or withdrawable	
							On backplate 	Through panel 
Possible, recommended or mandatory accessories:			No insulating accessory	Interphase barriers 	Long terminal shields 	Short terminal shields 	Short terminal shields 	Short terminal shields 
With:								
operating voltage	type of conductor							
≤ 500 V	Insulated bars 		Possible	Possible	Possible	Recommended	Recommended	Mandatory
	Extension terminals Cables + crimp lugs 		No	Mandatory (supplied)	Possible (instead of ph. barriers)	Recommended	Recommended	Mandatory
	Bare cables + connectors 		Possible for cable connectors BX100 to 250	Possible for cable connectors BX100 to 250	Possible for cable connectors BX100 to 250	Recommended	Recommended	Mandatory
> 500 V	Insulated bars 		No	No	Mandatory (use of short terminal shield possible)	Mandatory	Mandatory	Mandatory
	Extension terminals Cables + crimp lugs 		No	No	Mandatory	Mandatory	Mandatory	Mandatory

(1) Long terminal shields, mandatory if the device is fixed through the door, whatever the voltage.

■ Installation example

Safety clearance

Minimum distance between two adjacent circuit breakers

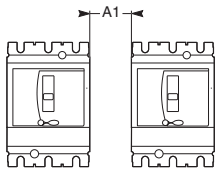

Minimum distance between circuit breaker and front or rear panels

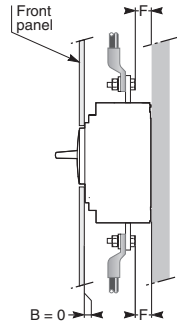

Bare or painted sheetmetal **Note:** if $F < 8$ mm: an insulating screen or long terminal shield is mandatory (see page 40).

Minimum distance between circuit breaker and top, bottom or side panels

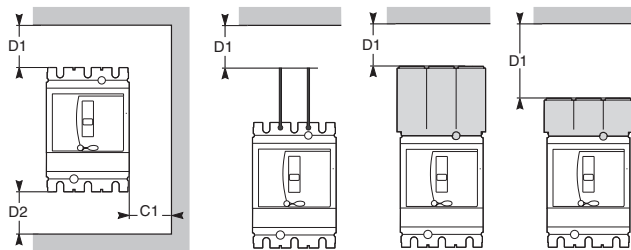

Devices without accessories. Devices with interphase barriers or long or short terminal shields.

Minimum safety clearances for BX100 to 630

Operating voltage	Clearance (mm)						
	Between devices	Between device and sheetmetal					
		Painted sheet metal			Bare sheet metal		
	A1	C1	D1	D2	C1	D1	D2
$U \leq 440$ V for devices equipped with:							
■ no accessories	0	0	30	30	5	40	40
■ short terminal shields	0	0	30	30	5	40	40
■ interphase barriers	0	0	0	0	5	0	0
■ long terminal shields	0	0	0	0	0	0	0
440 V < $U \leq 600$ V for devices equipped with:							
■ short terminal shields	0	0	30	30	10	40	40
■ interphase barriers ⁽¹⁾	0	0	0	0	20	10	10
■ long terminal shields ⁽²⁾	0	0	0	0	10	10	10
$U > 600$ V for devices equipped with:							
■ short terminal shields	0	10	50	50	20	100	100
■ long terminal shields	0	10	30	30	20	40	40

(1) Only for BX100 to 250.
(2) For all cases.

Clearances with respect to live bare busbars

Minimum clearances for BX100 to 630

Operating voltage	Clearances with respect to live bare busbars			
	spacing ≤ 60 mm		spacing > 60 mm	
	F1	F2	F1	F2
$U < 440$ V	350	350	80	80
440 V $\leq U \leq 600$ V	350	350	120	120
$U > 600$ V	prohibited: insulating screen required between device and busbars			

These clearances can be reduced for special installations as long as the configuration is checked by tests.

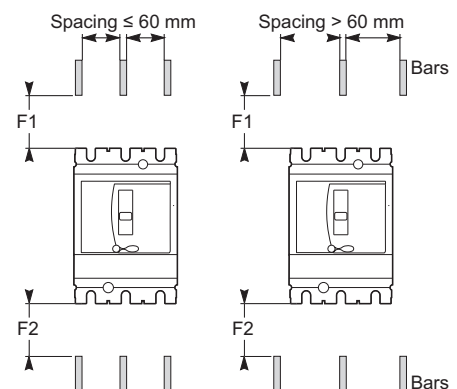

Live busbars.

Molded Case Circuit Breakers BX series (100AF to 630AF) Installation in switchboards

■ Installation example

Remote tripping by MN or MX release

Power consumption is approximately:

- 30 VA for pick-up of the MN and MX releases
- 300 VA to 500 VA for the motor mechanism.

The table below indicates the maximum permissible cable length for different supply voltages and cable cross-sectional areas.

Recommended maximum cable lengths (in metres)

Power supply voltage (V DC)		12 V		24 V		48 V	
Cable cross-section (mm ²)		1.5	2.5	1.5	2.5	1.5	2.5
MN	U source 100 %	15	–	160	–	640	–
	U source 85 %	7	–	40	–	160	–
MX	U source 100 %	60	–	240	–	960	–
	U source 85 %	30	–	120	–	480	–
Motor mechanism	U source 100 %	–	–	10	16	65	110
	U source 85 %	–	–	2	4	17	28

Note: the indicated length is that of each of the two wires.

External neutral voltage tap (ENVT)

This connection is required for accurate power measurements on 3-pole circuit breakers equipped with Control units 5 / 6 E in installations with a distributed neutral. It can be used to measure phase-neutral voltages and calculate power using the 3 wattmeter method.

BX 3-pole circuit breakers come with a wire installed on the device for the connection to the ENVT.

This wire is equipped with a connector for connection to an external wire with the following characteristics:

- cross-sectional area of 1 mm² to 2.5 mm²
- maximum length of 10 metres.

External neutral current transformer (ENCT)

This connection is required to protect the neutral on 3-pole circuit breakers equipped with Control units 5 / 6 A or E in installations with a distributed neutral. For unit 6 A or E, it is required for type G ground-fault protection.

The ENCT is connected in the same way for fixed, plug-in or withdrawable devices:

- fixed devices are connected via terminals T1 and T2 of the internal terminal block.
 - plug-in and withdrawable devices are not connected via the auxiliary terminals. The wires must be connected/disconnected inside the device via terminals T1 and T2.
- The ENCT must be connected to the Control unit trip unit by a shielded twisted pair. The shielding should be connected to the switchboard earth only at the CT end, no more than 30 cm from the CT.
- the power connections of the CT to the neutral (H2 and H1) must be made in the same way for power supply from the top or the bottom (see figure). Make sure they are not reversed for devices with power supply from the bottom.
 - cross-sectional area of 0.4 mm² to 1.5 mm²
 - maximum length of 10 metres.

ULP connection system between Control unit, FDM 121 switchboard display and Modbus interface

The ULP (Universal Logic Plug) wiring system used by BX for connections through to the Modbus network requires neither tools nor settings.

The prefabricated cords are used for both data transfer and

distribution of 24 V DC power. Connectors on each component are identified by ULP (Universal Logic Plug) symbols, ensuring total compatibility between each component.

Available cords

All connections are made with prefabricated cords:

- BX cord for connection of the internal terminal block to the Modbus interface or the FDM 121 display via an RJ45 connector. The cord is available in three lengths, 0.35 m, 1.3 m and 3 m
 - ULP cords with RJ45 connectors at each end for the other connections between components. The cord is available in six lengths, 0.3 m, 0.6 m, 1 m, 2 m, 3 m and 5 m. For greater distances, two cords can be interconnected using the RJ45 female/female accessory.
- Maximum length of 10 m between 2 modules and 30 m in all. A line terminator must be fitted to all components with an unused RJ45 connector.

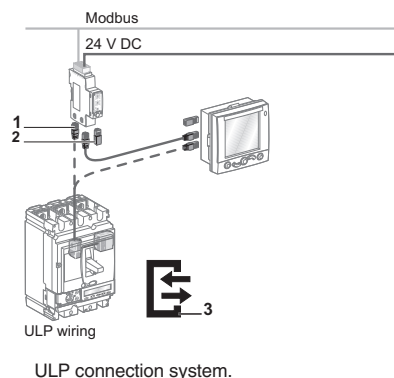
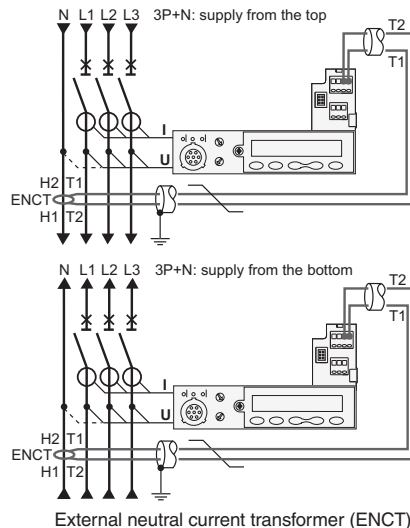
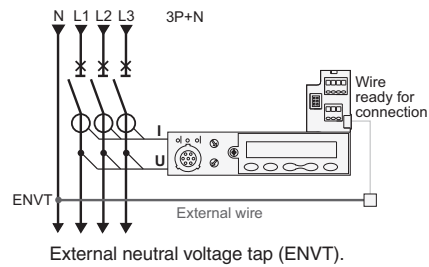

Molded Case Circuit Breakers BX series (100AF to 630AF) Installation in switchboards

24 V DC power-supply module

• Use

An external 24 V DC power supply is required for installations with communication, whatever the type of trip unit. On installations without communication, it is available as an option for Control units 5/6 to:

- modify settings when the circuit breaker is open (OFF position)
- display measurements when the current flowing through the circuit breaker is low
- maintain the display of the cause of tripping.

• Characteristics

The external 24 V DC supply may be used for the entire switchboard.

The required characteristics are indicated in the table below.

Characteristics	
Output voltage	24 V DC -20 % to +10 %
Ripple	±1 %
Overvoltage category (OVC)	OVC IV - as per IEC 60947-1

• Sizing

Sizing must take into account all supplied modules.

Module	Consumption (mA)
Control units 5 / 6	40
BSCM module	10
Modbus communication interface	60
BX cord U > 480 V AC	30
SDx module	20

• Wiring

Unit 5 or 6 not using the Communication function

The external 24 V DC supply is connected via the circuit breaker terminal block.

Use of a 24 V DC battery provides backup power for approximate 3 hours (100 mA) in the event of an interruption in the external supply.

Unit 5 or 6 using the Communication function

The external 24 V DC supply is connected via the Modbus interface using a five-pin connector, including two for the power supply. Stacking accessories (see page 29) can be used to supply a number of interfaces by fast clip-on connection.

The 24 V DC power is distributed downstream by the ULP (Universal Logic Plug) communication cords with RJ45 connectors. This system ensures both data transfer and power distribution to the connected modules.

Recommendations for 24 V DC wiring

- Do not connect the positive terminal to earth.
- Do not connect the negative terminal to earth.
- The maximum length for each conductor (+/-) is ten metres.
- For connection distances greater than ten metres, the plus and minus conductors of the 24 V DC supply must be twisted to improve EMC.
- The 24 V DC conductors must cross the power cables perpendicularly. If this is difficult or impossible, the plus and minus conductors must be twisted.

• Modbus

Each BX circuit breaker equipped with unit 5/6 and an FDM 121 display is connected to the Modbus network via the Modbus interface module.

Connection of all the circuit breakers and other Modbus devices in the switchboard to a Modbus bus is made much easier by using a Modbus RJ45 junction block installed in the switchboard.

Recommendations for Modbus wiring

- The shielding may be earthed.
- The conductors must be twisted to improve immunity (EMC).
- The Modbus conductors must cross the power cables perpendicularly.

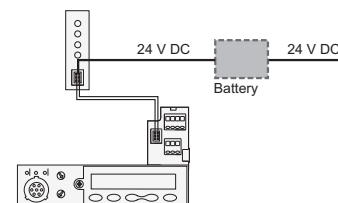

Power supply, without the Communication function, via the terminal block with a backup battery.

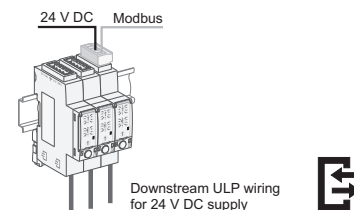

Supply, with the Communication function, via the Modbus interface.

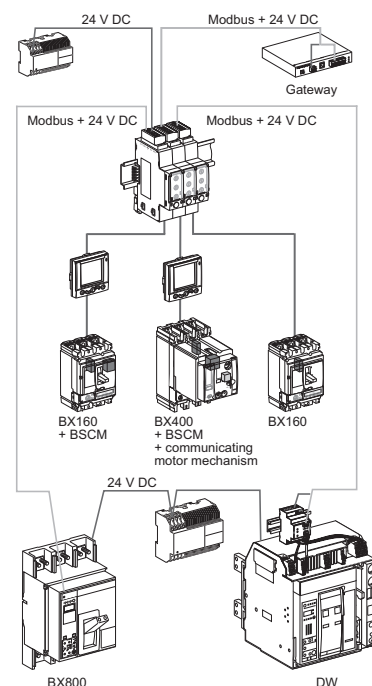

Molded Case Circuit Breakers BX series (100AF to 630AF) Temperature derating

■ BX100 to 250 equipped with thermal-magnetic trip units

The overload protection is calibrated at 40 °C in the lab. This means that when the ambient temperature is less or greater than 40 °C, the I_r protection pick-up is slightly modified.

To obtain the tripping time for a given temperature:

- see the tripping curves for 40 °C (see page 76 and page 77)
- determine tripping times corresponding to the I_r value (thermal setting on the device), corrected for the ambient temperature as indicated in the tables below.

Settings of BX100 to 250 equipped with TM-D trip units, as a function of the temperature

The table indicates the real I_r (A) value for a given rating and temperature.

Rat. (A)	Temperature (°C)													
	10	15	20	25	30	35	40	45	50	55	60	65	70	
16	18.4	18.7	18	18	17	16.6	16	15.6	15.2	14.8	14.5	14	13.8	
25	28.8	28	27.5	27	26.3	25.6	25	24.5	24	23.5	23	22	21	
32	36.8	36	35.2	34.4	33.6	32.8	32	31.3	30.5	30	29.5	29	28.5	
40	46	45	44	43	42	41	40	39	38	37	36	35	34	
50	57.5	56	55	54	52.5	51	50	49	48	47	46	45	44	
63	72	71	69	68	66	65	63	61.5	60	58	57	55	54	
80	92	90	88	86	84	82	80	78	76	74	72	70	68	
100	115	113	110	108	105	103	100	97.5	95	92.5	90	87.5	85	
125	144	141	138	134	131	128	125	122	119	116	113	109	106	
160	184	180	176	172	168	164	160	156	152	148	144	140	136	
200	230	225	220	215	210	205	200	195	190	185	180	175	170	
250	288	281	277	269	263	256	250	244	238	231	225	219	213	

Example 1. What is the tripping time of a BX100 equipped with a TM100D trip unit set to 100 A, for an overload I = 500 A?

The overload I/I_r is calculated as a function of the temperature. Use the above values and the curve on page 77 (shown on the left) to determine the corresponding time.

- At 40 °C, I_r = 100 A, I/I_r = 5 and the tripping time is between 6 and 60 seconds.
- At 20 °C, I_r = 110 A, I/I_r = 4.54 and the tripping time is between 8 and 80 seconds.
- At 60 °C, I_r = 90 A, I/I_r = 5.55 and the tripping time is between 5 and 50 seconds.

Example 2. What is the setting to obtain a real I_r of 210 A, taking into account the temperature, for a BX250 equipped with a TM250D trip unit?

The necessary dial setting, in amperes, is shown below.

- At 40 °C, I_r = (210/250) x 250 A = 210 A
- At 20 °C, I_r = (210/277) x 250 A = 189.5 A
- At 60 °C, I_r = (210/225) x 250 A = 233 A

Additional derating coefficient for an add-on module

The values indicated in the previous tables are valid for fixed circuit breakers equipped with one of the following modules:

- insulation monitoring module
- ammeter module
- current-transformer module.

They also apply for plug-in circuit breakers equipped with:

- ammeter module
- current-transformer module.

However, for plug-in circuit breakers equipped with an insulation monitoring module, the coefficient 0.84 must be applied.

The table below sums up the situation for add-on modules.

Type of device	Circuit breaker	TM-D trip-unit rating	Vigi or insulation monitoring module	Ammeter or current transformer module
Fixed	BX100	16 to 100	1	1
	BX160 to 250	125 to 160		
	BX250	200 to 250		
Plug-in	BX100	16 to 100	0.84	
	BX160	125 to 160		
	BX250	200 to 250		

When thermal-magnetic trip units are used at ambient temperatures other than 40 °C, the I_r pick-up is modified.

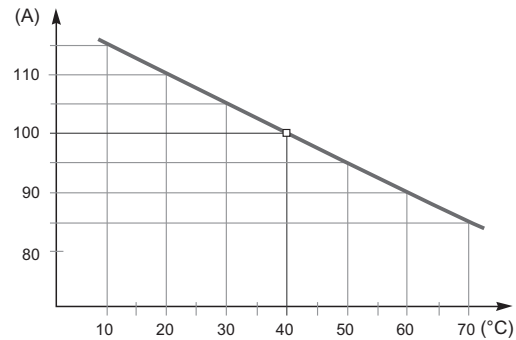

Temperature derating curve for BX100.

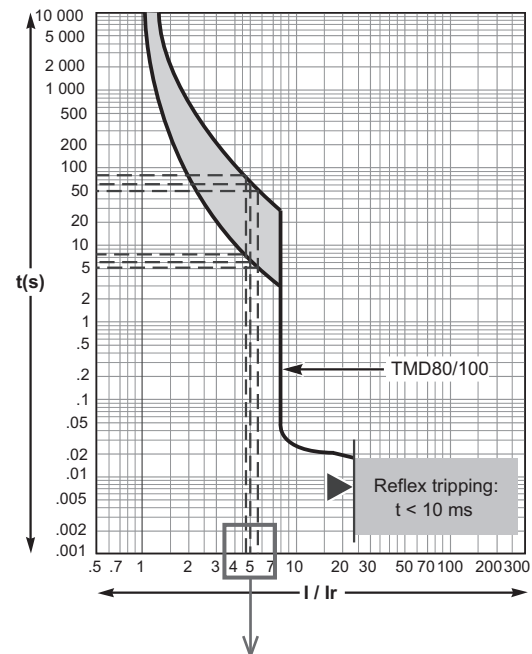

Example 1. Fault I = 500 A

I/I _r	4.5	5	5.5
T °C	20 °C	40 °C	60 °C
t min.	8 s	6 s	5 s
t max.	80 s	60 s	50 s

Thermal-protection curve with minimum and maximum values.

Molded Case Circuit Breakers BX series (100AF to 630AF) Temperature derating

■ BX equipped with electronic trip units

Changes in temperature do not affect measurements by electronic trip units.

- The built-in CT sensors with Rogowski toroids measure the current.
- The control electronics compare the value of the current to the settings defined for 40 °C.

Because temperature has no effect on the toroid measurements, the tripping thresholds do not need to be modified.

However, the temperature rise caused by the flow of current and the ambient temperature increase the temperature of the device. To avoid reaching the thermal withstand level of the equipment, it is necessary to limit the current flowing through the device, i.e. the maximum Ir setting as a function of the temperature.

BX100/160/250

The table below indicates the maximum long-time (LT) protection setting Ir (A) depending on the ambient temperature.

Type of device	Rating (A)	Temperature (°C)							
		40	45	50	55	60	65	70	
BX100/160									
Fixed, plug-in or withdr.		no derating							
BX250									
Fixed, plug-in	100	no derating							
	160	no derating							
Fixed	250	250	250	250	245	237	230	225	
Plug-in	250	250	245	237	230	225	220	215	

BX400 and 630

The table below indicates the maximum long-time (LT) protection setting Ir (A) depending on the ambient temperature.

Type of device	Rating (A)	Temperature (°C)							
		40	45	50	55	60	65	70	
BX400									
Fixed	400	400	400	400	390	380	370	360	
Plug-in	400	400	390	380	370	360	350	340	
BX630									
Fixed	630	630	615	600	585	570	550	535	
Plug-in	630	570	550	535	520	505	490	475	

Example. A fixed BX400 equipped with a Control unit can have a maximum Ir setting of:

- 400 A up to 50 °C
- 380 A up to 60 °C.

Additional derating coefficient for an add-on module

For fixed or plug-in circuit breakers, the addition of a:

- insulation-monitoring module
- ammeter module
- current-transformer module

can modify the derating values. Apply the coefficients shown below.

Derating of a BX equipped with a Control unit

Type of device	Circuit breaker	Control unit rating	Insulation monitoring module	Ammeter module / External sensor (CT)
Fixed	BX100	40 to 100	1	1
	BX160	160		
	BX250	100 to 250		
Plug-in	BX100	40 to 100	0.86	1
	BX160	160		
	BX250	100 to 250		
Fixed	BX400	400	0.97	
	BX630	630	0.90	
Plug-in	BX400	400	0.97	
	BX630	630	0.90	

Electronic trip units are not affected by variations in temperature. If the trip units are used in high-temperature environments, the Control unit setting must nevertheless take into account the temperature limits of the circuit breaker.

Molded Case Circuit Breakers

BX series (100AF to 630AF)

Power loss/ Resistance

■ BX100 to 250 equipped with thermal-magnetic trip units

The values indicated in the tables below are typical values for a device at full rated load and 50/60 Hz.

Power loss per pole (P/pole) in Watts (W)

The value indicated is the power loss at IN, 50/60 Hz, for a three-pole or four-pole circuit breaker. Measurement and calculation of power loss are carried out in compliance with the recommendations of Annex G of standard IEC 60947-2.

Resistance per pole (R/pole) in milliohms (mW)

The value of the resistance per pole is provided as a general indication for a new device. The value of the contact resistance must be determined on the basis of the measured voltage drop, in accordance with the manufacturer's test procedure (ABT instruction document no. 1 - BEE - 02.2 -A).

This measurement is not sufficient to determine the quality of the contacts, i.e. the capacity of the circuit breaker to carry its rated current.

Additional power loss

Additional power loss is equal to the sum of the power dissipated by the following:

- disconnecting contacts (plug-in devices)
- ammeter module
- transformer module.

Calculation of total power loss

Total power loss at full rated load and 50/60 Hz is equal to the sum of the device and additional power losses per pole multiplied by the number of poles (2, 3 or 4).

BX100 to 250 equipped with TM-D trip units

Type of device	Fixed device			Additional power / pole		
	3/4 poles	Rat. (A)	R/pole	P/pole	Plug-in	Ammeter module
BX100	16	11.42	2.92	0	0	0
	25	6.42	4.01	0.1	0	0
	32	3.94	4.03	0.15	0.1	0.1
	40	3.42	5.47	0.2	0.1	0.1
	50	1.64	4.11	0.3	0.1	0.1
	63	2.17	8.61	0.4	0.1	0.1
	80	1.37	8.77	0.6	0.1	0.1
	100	0.88	8.8	1	0.2	0.2
BX160	125	0.69	10.78	1.6	0.3	0.3
	160	0.55	13.95	2.6	0.5	0.5
BX250	200	0.39	15.4	4	0.8	0.8
	250	0.3	18.75	6.3	1.3	1.3

■ BX equipped with electronic trip units

The values indicated in the table below are typical values for a device at full rated load and 50/60 Hz. The definitions and information are the same as that for circuit breakers equipped with thermal-magnetic trip units.

BX100 to 630 equipped with Control unit trip units

Type of device	Fixed device			Additional power / pole		
	3/4 poles	Rat. (A)	R/pole	P/pole	Plug-in	Ammeter module
BX100	40	0.84	1.34	0.2	0.1	0.1
	100	0.468	4.68	1	0.2	0.2
BX160	160	0.36	9.16	2.6	0.5	0.5
BX250	100	0.27	2.73	1.6	0.2	0.2
	250	0.28	17.56	6.3	1.3	1.3
BX400	400	0.12	19.2	9.6	2.4	2.4
BX630	630 ⁽¹⁾	0.1	39.69	19.49	5.95	5.95

(1) The power loss values for the withdrawable circuit breakers are given for 570 A.

BX thermal power loss values are used to calculate total temperature rise in the switchboard in which the circuit breakers are installed.

Molded Case Circuit Breakers BX series (100AF to 630AF) Dimensions and mounting

■ BX100 to 630 fixed version

Dimensions

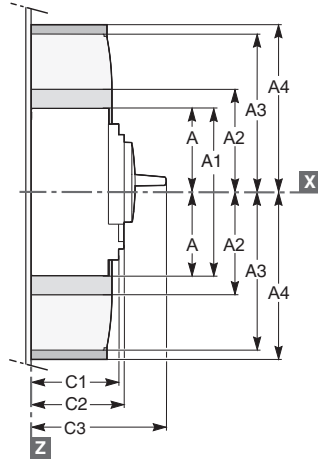
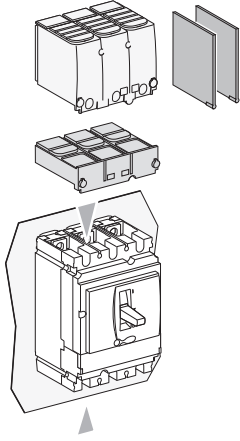

2/3P

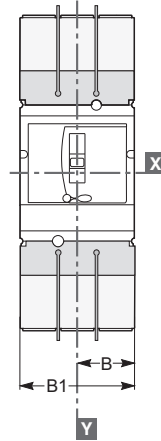

4P

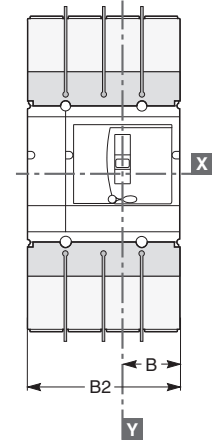

Interphase barriers.
 Short terminal shields.

Long terminal shields (also available for BX400/630 spreaders with 52.5 mm pitch:
 B1 = 157.5 mm, B2 = 210 mm).

Mounting

On backplate

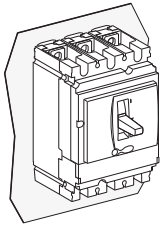

BX100 to 250

2/3P

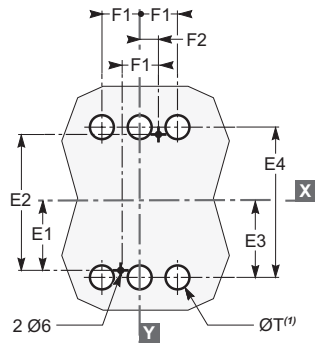

BX400/630

3P

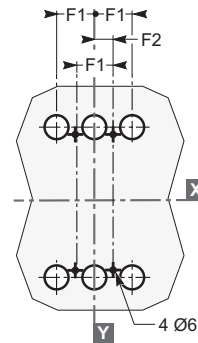

BX100 to 630

4P

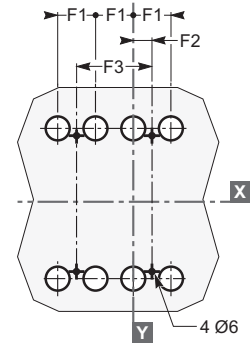

(1) The ØT holes are required for rear connection only.
 For two-pole circuit breakers, the middle holes are not required.

On rails

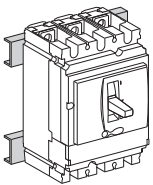

2/3P

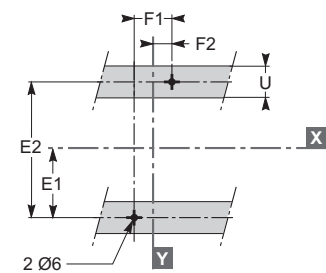

3P

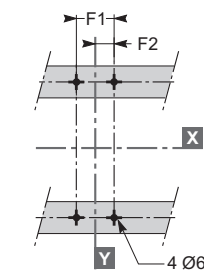

4P

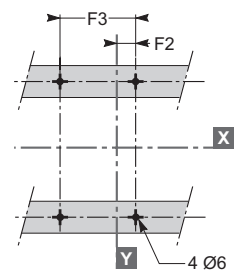

On DIN rail with adapter plate (BX100 to 250)

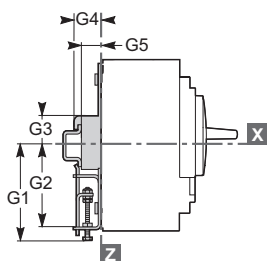
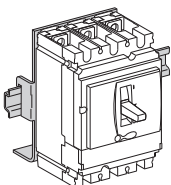

Molded Case Circuit Breakers BX series (100AF to 630AF) Dimensions and mounting

■ BX100 to 630 plug-in version

Dimensions

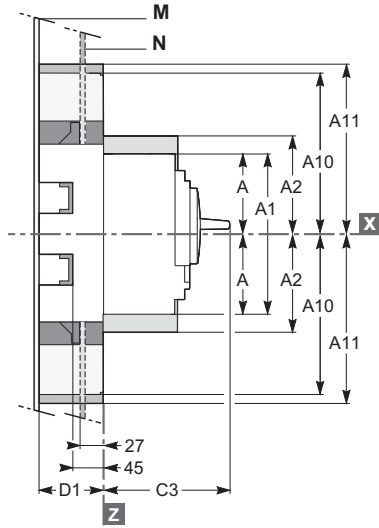
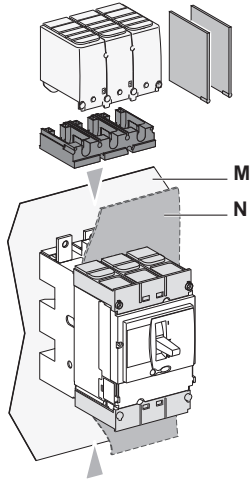

2/3P

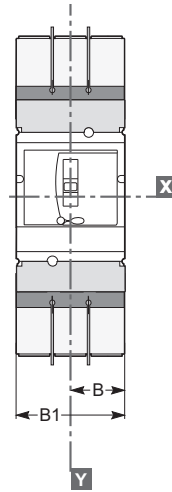

4P

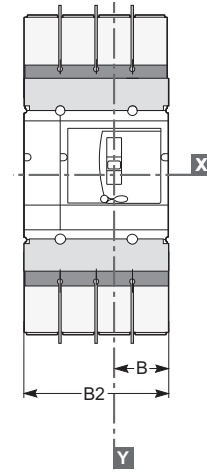

Interphase barriers for base.
 Short terminal shields on circuit breaker.

Long terminal shields (also available for BX400/630 spreaders with 52.5 mm pitch:
 B1 = 157.5 mm, B2 = 210 mm).
 Adapter for base, required to mount long terminal shields or interphase barriers.

Mounting

Through front panel (N)

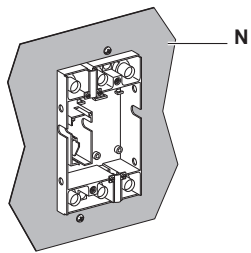

2/3P BX100 to 250

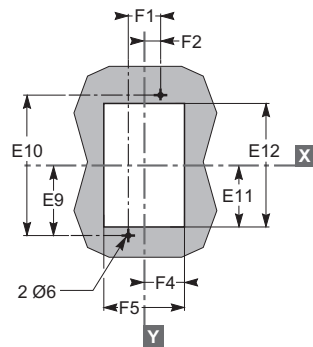

3P BX400/630

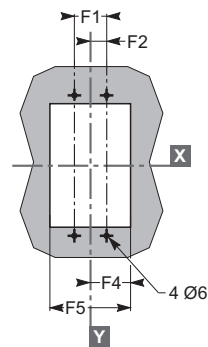

4P BX100 to 630

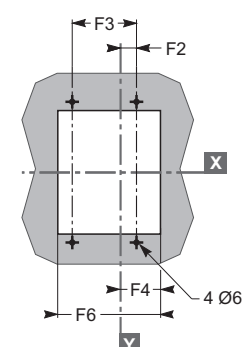

Molded Case Circuit Breakers BX series (100AF to 630AF) Dimensions and mounting

On backplate (M)

Front connection (an insulating screen is supplied with the base and must be fitted between the base and the backplate)

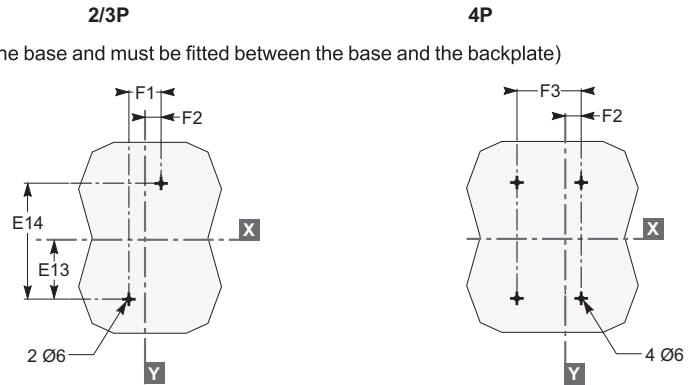
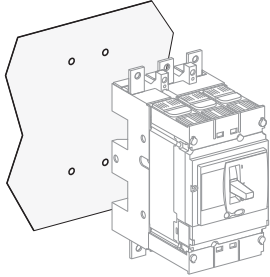

Connection by exterior-mounted rear connectors

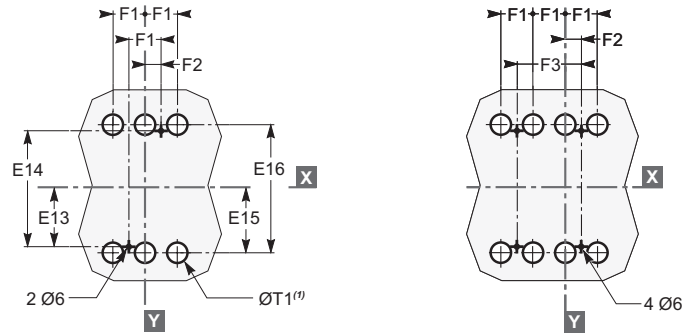
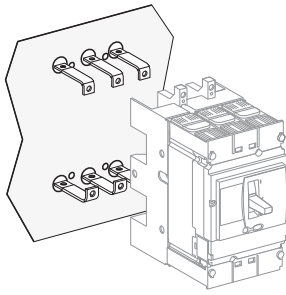

(1) The ØT1 holes are required for rear connection only (for two-pole circuit breakers, the middle holes are not required).

Connection by interior-mounted rear connectors

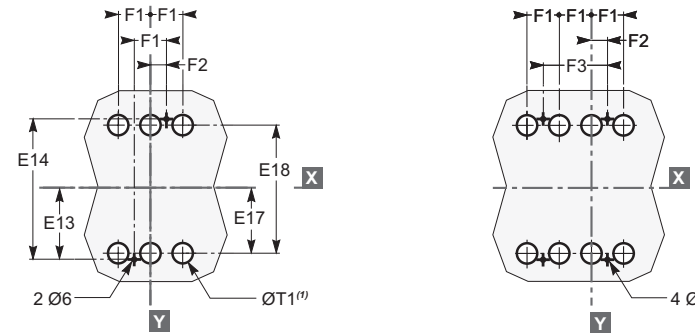
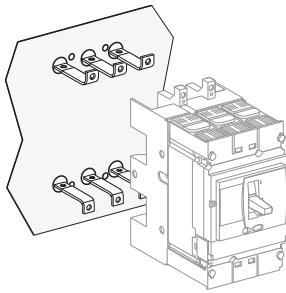

(1) The ØT1 holes are required for rear connection only (for two-pole circuit breakers, the middle holes are not required).

On rails

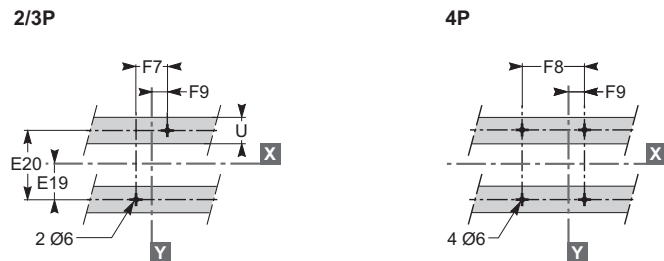
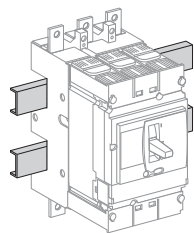

Type	A	A1	A2	A10	A11	B	B1	B2	C3	D1	E9	E10	E11	E12	E13	E14	E15
BX100/160/250	80.5	161	94	175	210	52.5	105	140	126	75	95	190	87	174	77.5	155	79
BX400/630	127.5	255	142.5	244	281	70	140	185	168	100	150	300	137	274	125	250	126
Type	E16	E17	E18	E19	E20	F1	F2	F3	F4	F5	F6	F7	F8	F9	ØT1	U	
BX100/160/250	158	61	122	37.5	75	35	17.5	70	54.5	109	144	70	105	35	24	y 32	
BX400/630	252	101	202	75	150	45	22.5	90	71.5	143	188	100	145	50	33	y 35	

Molded Case Circuit Breakers BX series (100AF to 630AF) Dimensions and mounting

Motor mechanism module for BX100 to 630

Dimensions

Fixed circuit breaker

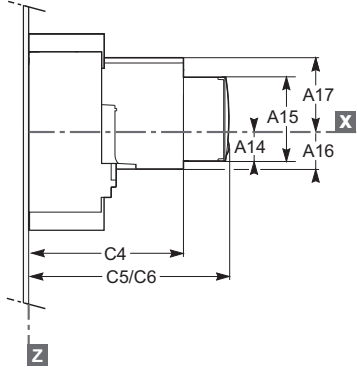
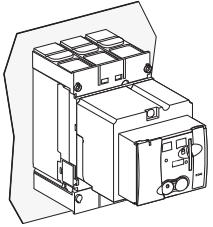

C5: without keylock
C6: with keylock

3P

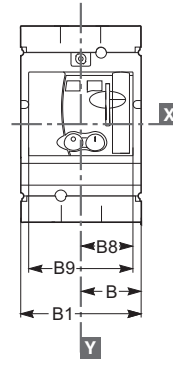

4P

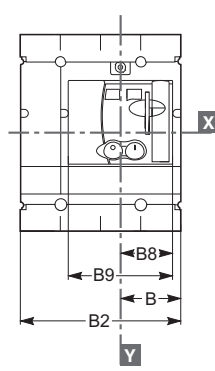

Plug-in circuit breaker

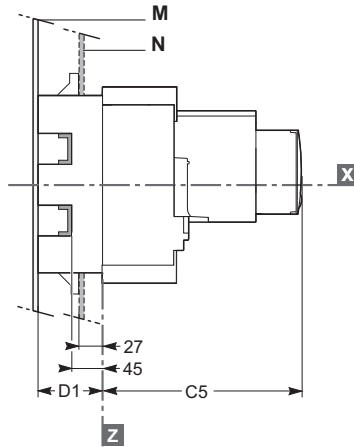
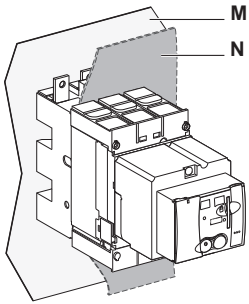

Molded Case Circuit Breakers BX series (100AF to 630AF) Dimensions and mounting

■ Direct rotary handle for BX100 to 630

Dimensions

Fixed circuit breaker

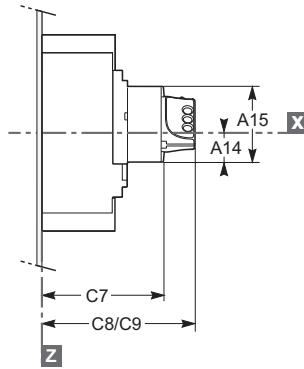
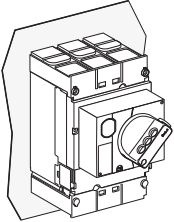

C8: without keylock
C9: with keylock

3P

4P

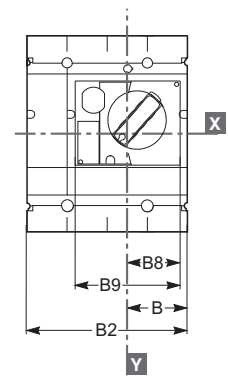
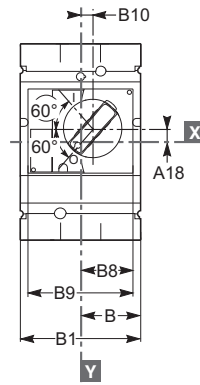

Plug-in circuit breaker

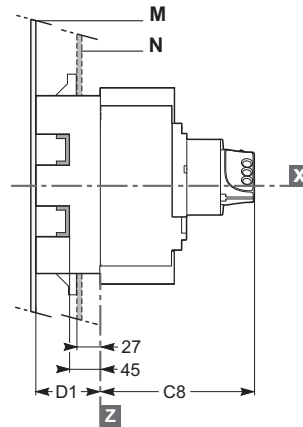
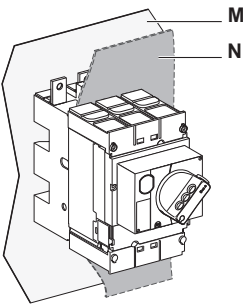

Molded Case Circuit Breakers BX series (100AF to 630AF) Dimensions and mounting

Extended rotary handle for BX100 to 630

Dimensions

Fixed and plug-in circuit breakers

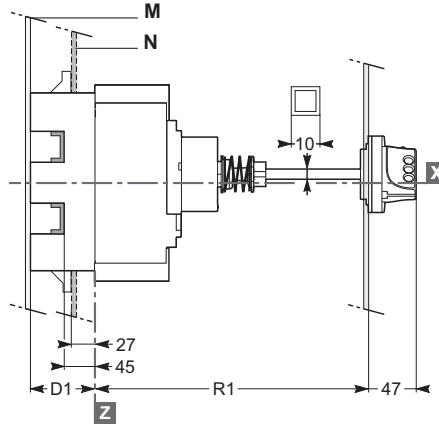
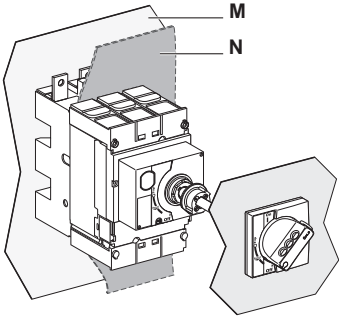

Cutout for shaft (mm)

Type	R1
BX100/160/250	min. 171 max. 600
BX400/630	min. 195 max. 600

Dimensions and front-panel cutout

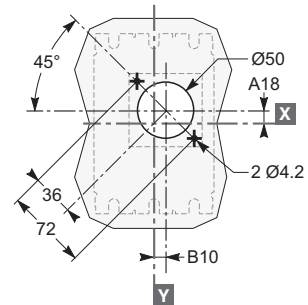
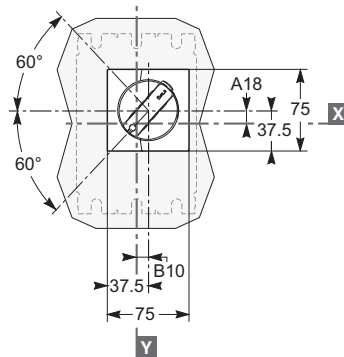

Type	A18	B10	D1
BX100/160/250	9	9.25	75
BX400/630	24.6	5	100

Molded Case Circuit Breakers BX series (100AF to 630AF) Power connections

■ BX100 to 630 fixed version

Connection locations

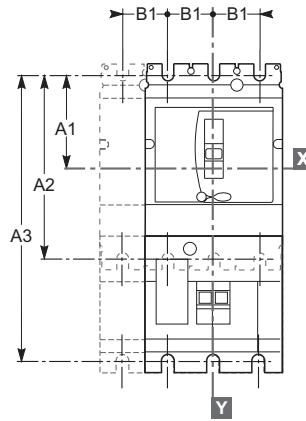
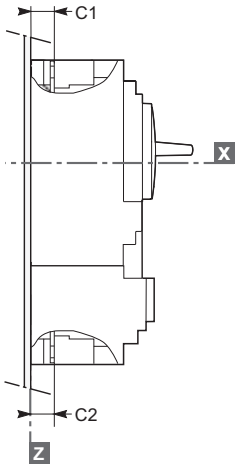

Type	A1	A2	B1	C1	C2
BX100/160	70	140	35	19.5	19.5
BX250	70	140	35	21.5	19.5
BX400/630	113.5	227	45	26	26

Front connection without accessories

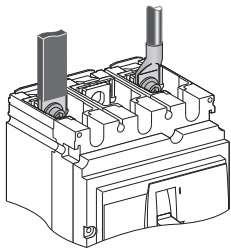

BX100 to 250

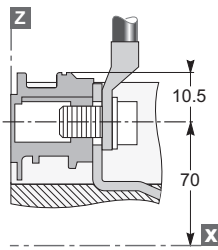

Cables with lugs/bars

BX400/630

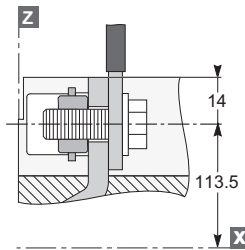

Bars/cables with lugs

Connection with accessories

Long and short rear connectors

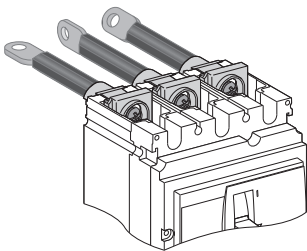

BX100 to 250

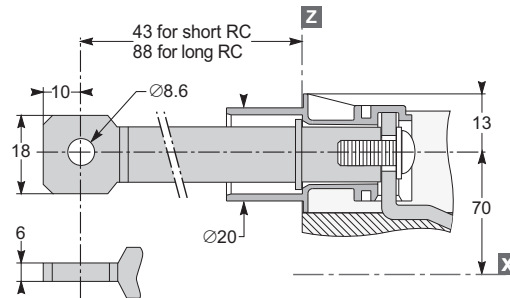

BX400/630

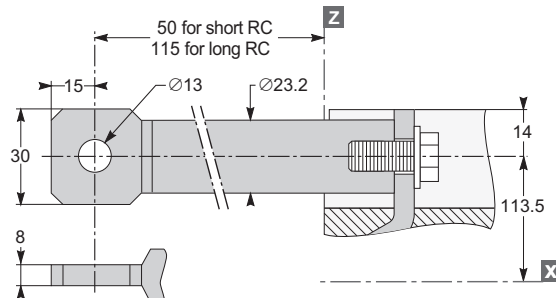

Molded Case Circuit Breakers
BX series (100AF to 630AF)
Power connections

Connection with accessories (cont.)

Spreaders

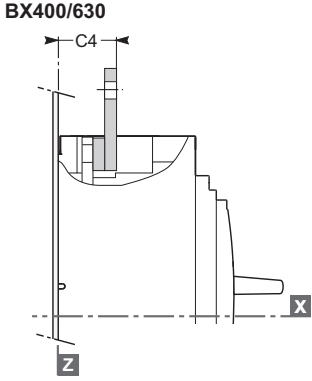
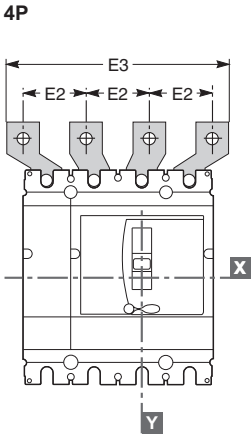
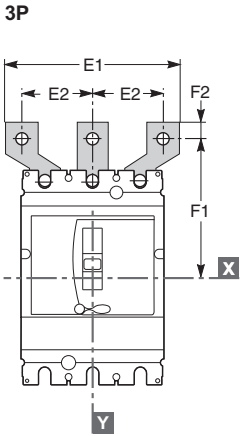
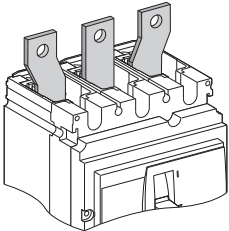

Type	C4	E1	E2	E3	F1	F2
BX400/630	44	135	52.5	187.5	152.5	15
		170	70	240	166	15

Molded Case Circuit Breakers BX series (100AF to 630AF) Power connections

■ BX100 to 630 plug-in versions

Connection locations

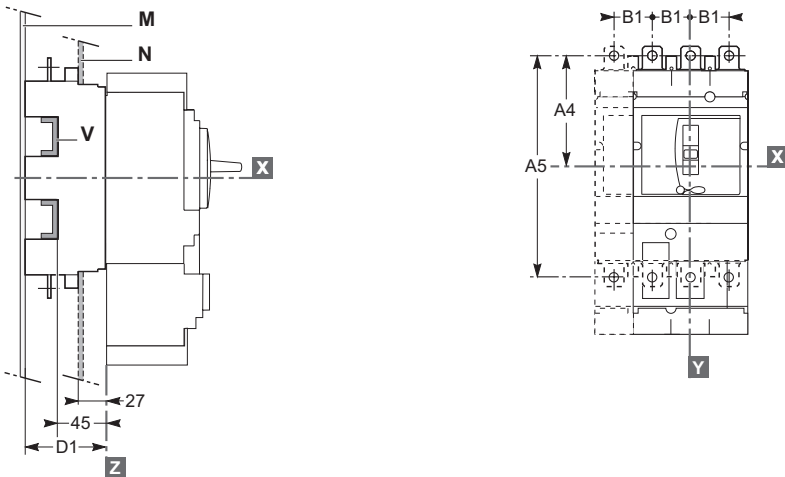

Type	A4	A5	B1	D1
BX100 to 250	100	200	35	75
BX400/630	156.5	313	45	100

Note:
b for mounting on a backplate, the insulating screen supplied with the plug-in base must be installed.
b for withdrawable versions, terminal shields are recommended.

Connection without accessories

Front connection: mounting on backplate (M) or rails (V)

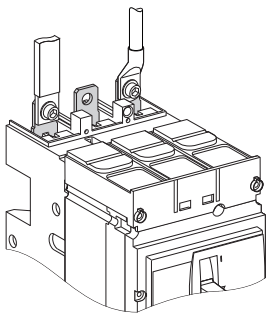

BX100 to 250

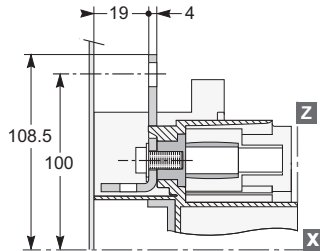

BX400/630

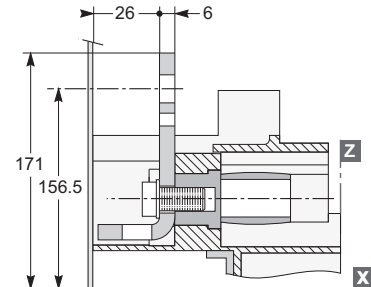

Rear connection: mounting through front panel (N) or on rails (V)

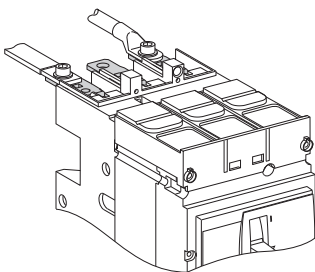

BX100 to 250

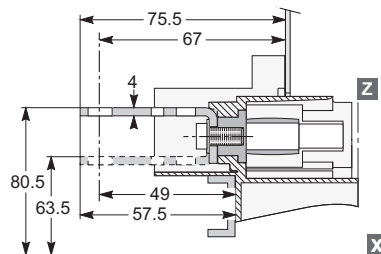

BX400/630

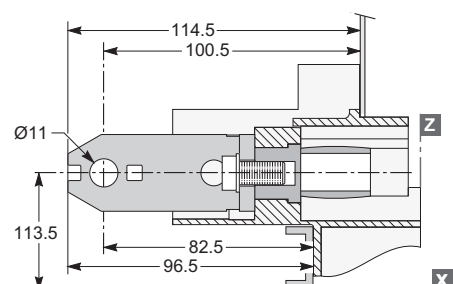
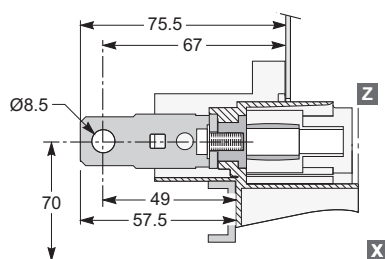
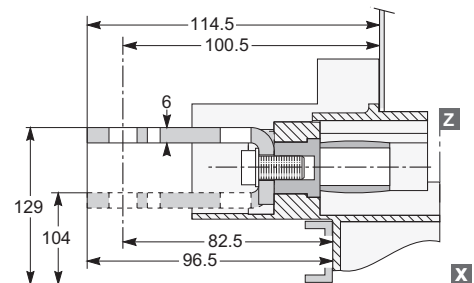

Molded Case Circuit Breakers BX series (100AF to 630AF) Power connections

Connection with accessories (cont.)

Spreaders: mounting on backplate (M) or rails (V)

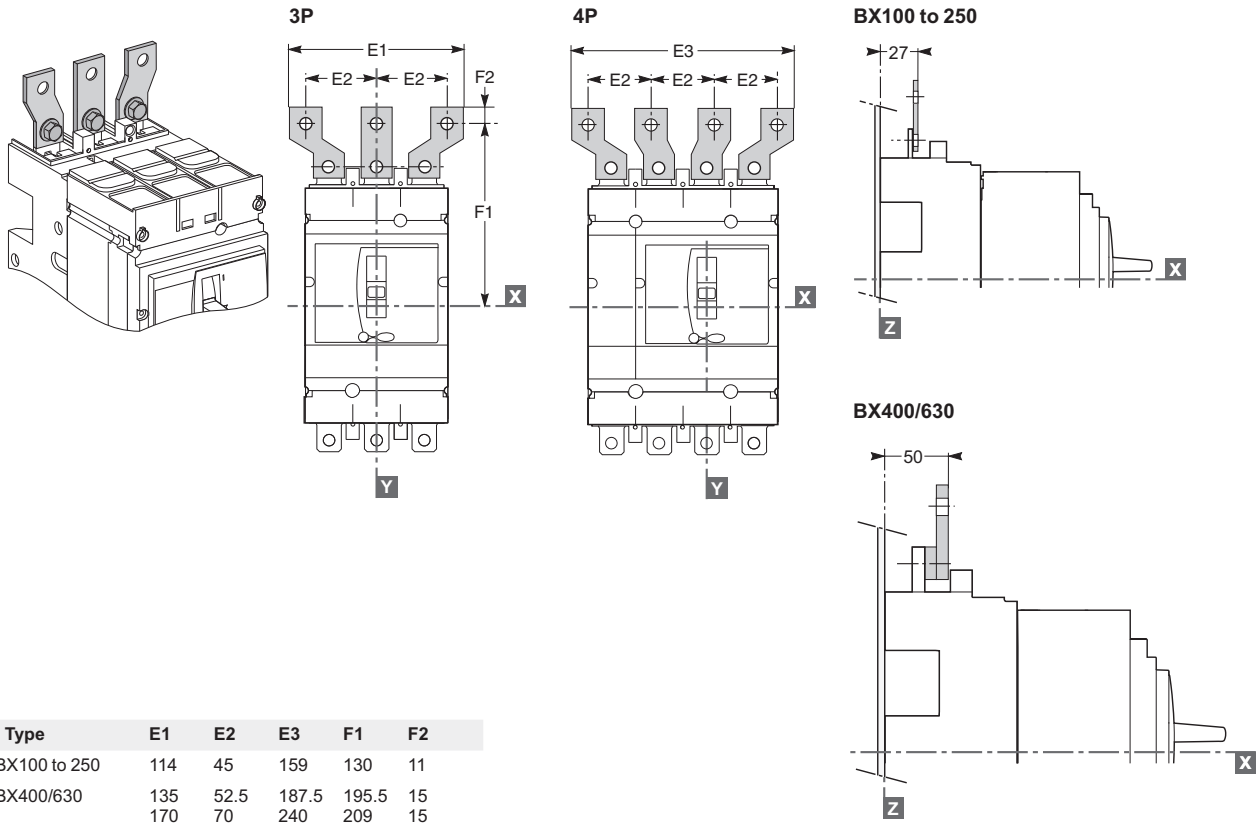

Long insulated rear connectors: mounting on backplate (M) or rails (V)

Exterior-mounted rear connectors

BX100 to 250

BX400/630

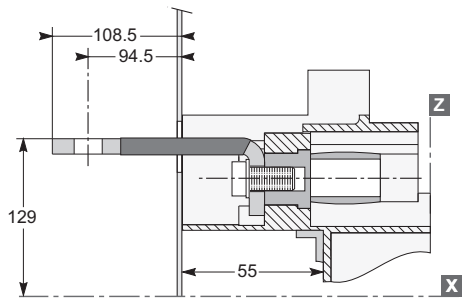
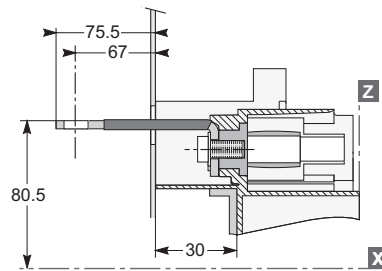
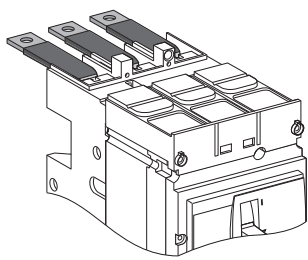

Interior-mounted rear connectors

BX100 to 250

BX400/630

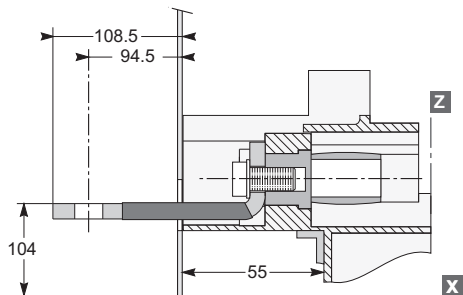
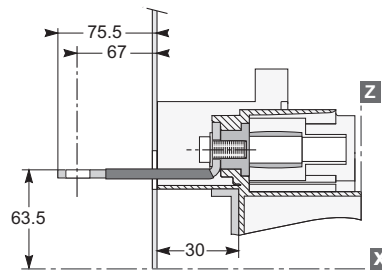
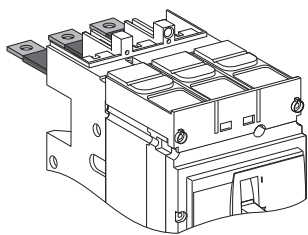

Long, insulated connectors are mandatory.

Molded Case Circuit Breakers BX series (100AF to 630AF) Power connections

■ Connection of insulated bars or cables with lugs to BX100 to 630

Direct connection to BX100 to 630				
Dimensions		BX100	BX160/250	BX400/630
Bars	L (mm)	≤ 25	≤ 25	≤ 32
	l (mm)	d + 10	d + 10	d + 15
	d (mm)	≤ 10	≤ 10	≤ 15
	e (mm)	≤ 6	≤ 6	3 ≤ e ≤ 10
	Ø (mm)	6.5	8.5	10.5
Lugs	L (mm)	≤ 25	≤ 25	≤ 32
	Ø (mm)	6.5	8.5	10.5
Torque (Nm) ⁽¹⁾		10	15	50
Torque (Nm) ⁽²⁾		5/5	5/5	20/11
Torque (Nm) ⁽³⁾		8	8	20

- (1) Tightening torque on the circuit breaker for lugs or bars.
 (2) Tightening torque on fixed devices for rear connectors/tightening torque on plug-in or withdrawable devices for power connectors.
 (3) Tightening torque on the plug-in base for terminal extensions.

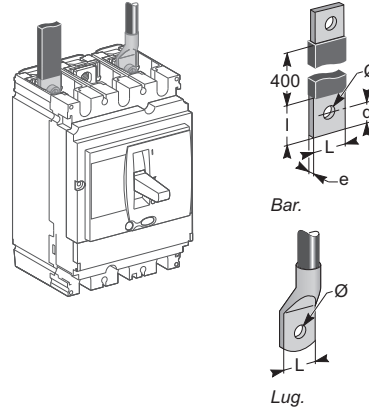

Connection with accessories to BX100 to 250 (IEC 228)			
Pole pitch			
Without spreaders		35 mm	
With spreaders		45 mm	
Dimensions		With spreaders or terminal extensions	
		BX100	BX160/250
Bars	L (mm)	≤ 25	≤ 25
	l (mm)	20 ≤ l ≤ 25	20 ≤ l ≤ 25
	d (mm)	≤ 10	≤ 10
	e (mm)	≤ 6	≤ 6
	Ø (mm)	6.5	8.5
Lugs	L (mm)	≤ 25	≤ 25
	Ø (mm)	6.5	8.5
Torque (Nm) ⁽¹⁾		10	15
Torque (Nm) ⁽²⁾		5	5

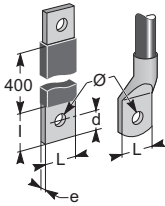

- (1) Tightening torque on the circuit breaker for spreaders or terminal extensions.
 (2) Tightening torque on the plug-in base for spreaders or terminal extensions.
 Spreaders and straight, right-angle, 45°, double-L and edgewise terminal extensions are supplied with flexible interphase barriers.

Connection with accessories to BX400 and 630 (IEC 228)					
Pole pitch					
Without spreaders		45 mm			
With spreaders		52.5 or 70 mm			
Dimensions		With spreaders		With terminal extensions	
Bars	L (mm)	≤ 40	≤ 32		
	l (mm)	d + 15	30 ≤ l ≤ 34		
	d (mm)	≤ 20	≤ 15		
	e (mm)	3 ≤ e ≤ 10	3 ≤ e ≤ 10		
	Ø (mm)	12.5	10.5		
	Lugs	L (mm)	≤ 40	≤ 32	
Ø (mm)		12.5	10.5		
Torque (Nm) ⁽¹⁾		50	50		
Torque (Nm) ⁽²⁾		20	20		

- (1) Tightening torque on the circuit breaker for spreaders or terminal extensions.
 (2) Tightening torque on the plug-in base for spreaders or terminal extensions.
 Spreaders and right-angle, 45° and edgewise terminal extensions are supplied with flexible interphase barriers.

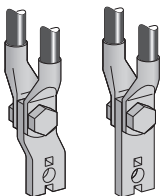

Mounting detail: 2 cables with lugs.

Accessories for BX400 and 630 Spreaders made up of separate parts for 52.5 and 70 mm pitch

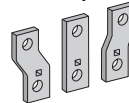

Tinned copper

For U > 600 V, use of the 52.5 mm pitch spreaders requires a specific insulation kit.
 The 70 mm pitch spreaders may not be used.

Molded Case Circuit Breakers BX series (100AF to 630AF) Wiring diagrams

■ BX100 to 630 Fixed circuit breakers

Power

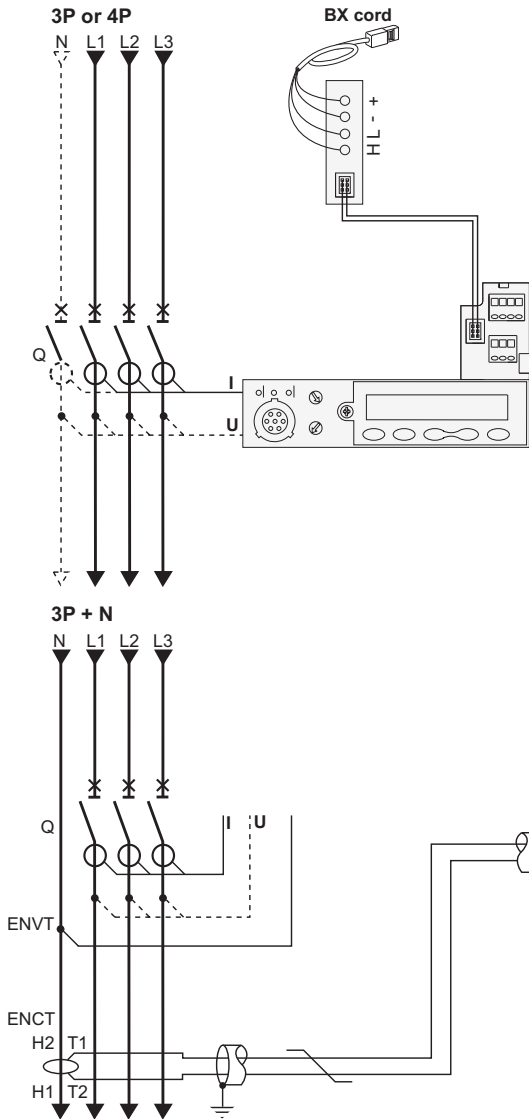

Control unit

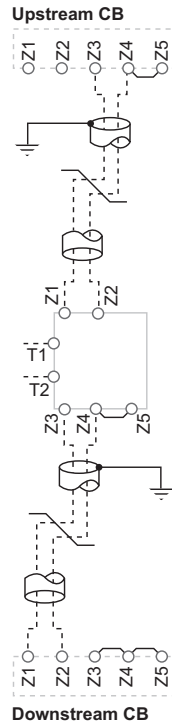

Remote operation

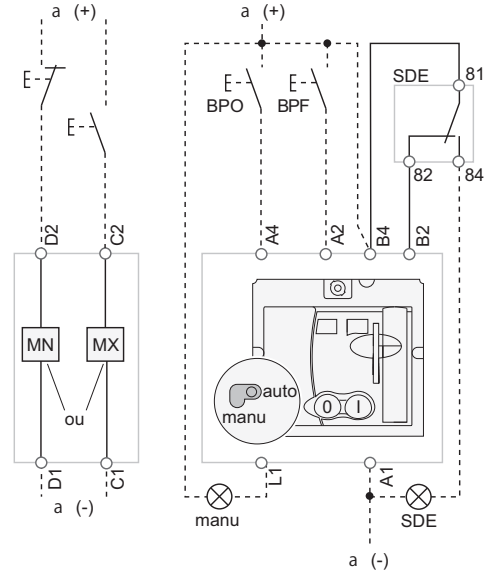

Motor mechanism (MT)

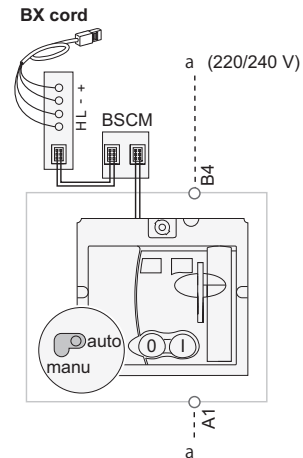

Communicating motor mechanism (MTc)

Control unit A or E

A/E Communication
H(WH), L(BL): data
- (BK), + (RD): 24 V DC power supply

A/E ZSI (Zone Selective Interlocking)
Z1: ZSI OUT SOURCE
Z2: ZSI OUT
Z3: ZSI IN SOURCE
Z4: ZSI IN ST (short time)
Z5: ZSI IN GF (ground fault)
Note: Z3, Z4, Z5 for BX400/630 only.

A/E ENCT: external neutral current transformer:
- shielded cable with 1 twisted pair (T1, T2)
- shielding earthed at one end only (CT end).
Connection L = 30 cm max.
- maximum length of 10 metres
- cable size 0.4 to 1.5 mm²
- recommended cable: Belden 8441 or equivalent.

E ENVT: external neutral voltage tap for connection to the neutral via a 3P circuit breaker.

Remote operation

MN: undervoltage release

or

MX: shunt release

Motor mechanism (MT)

A4: opening order
A2: closing order
B4, A1: power supply to motor mechanism
L1: manual position (manu)
B2: SDE interlocking (mandatory for correct operation)

BPO: opening pushbutton

BPF: closing pushbutton

Communicating motor mechanism (MTc)

B4, A1: motor mechanism power supply
BSCM: breaker status and control module

Indication contacts

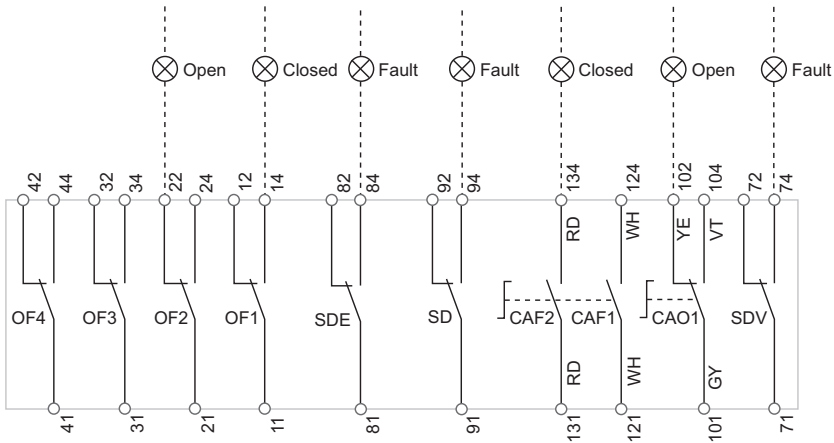

The diagram is shown with circuits de-energised, all devices open, connected and charged and relays in normal position.

Terminals shown in red O must be connected by the customer.

Indication contacts

- OF2 / OF1:** device ON/OFF indication contacts
- OF4 / OF3:** device ON/OFF indication contacts (BX400/630)
- SDE:** fault-trip indication contact (short-circuit, overload, ground fault, earth leakage)
- SD:** trip-indication contact
- CAF2/CAF1:** early-make contact (rotary handle only)
- CAO1:** early-break contact (rotary handle only)

Colour code for auxiliary wiring

- | | |
|-------------------|-------------------|
| RD: red | VT: violet |
| WH: white | GY: grey |
| YE: yellow | OR: orange |
| BK: black | BL: blue |
| GN: green | |

Molded Case Circuit Breakers BX series (100AF to 630AF) Wiring diagrams

■ BX100 to 630 Plug-in circuit breakers

Power

Control unit

Remote operation

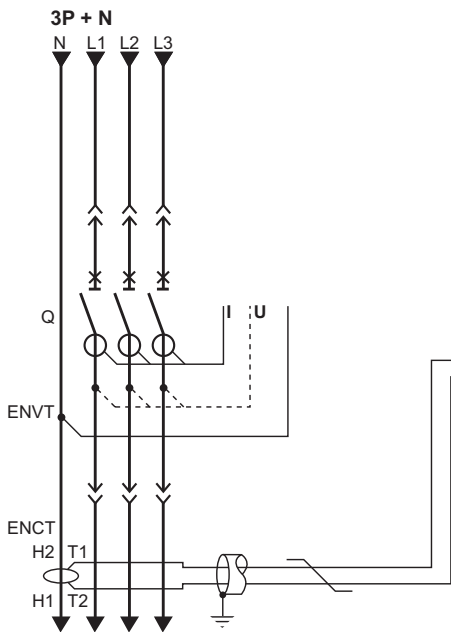
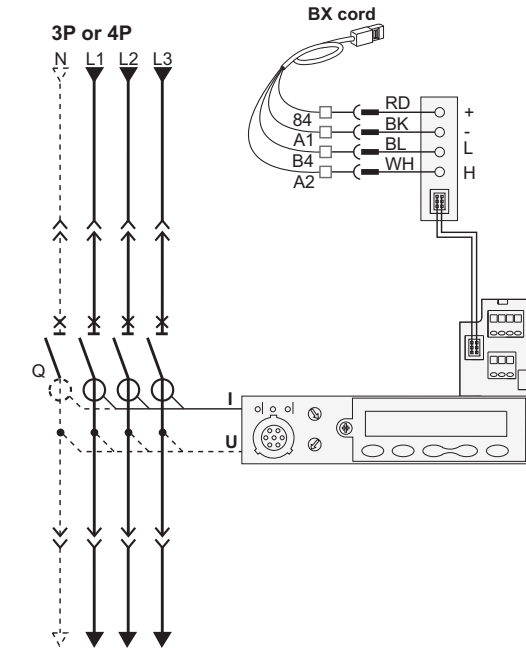

Upstream CB

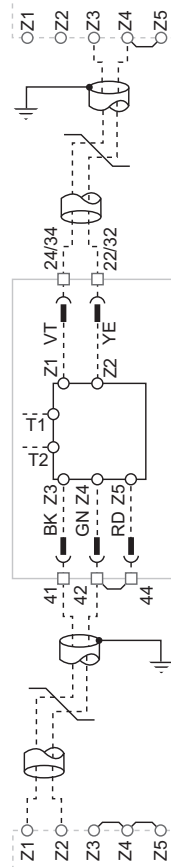

Downstream

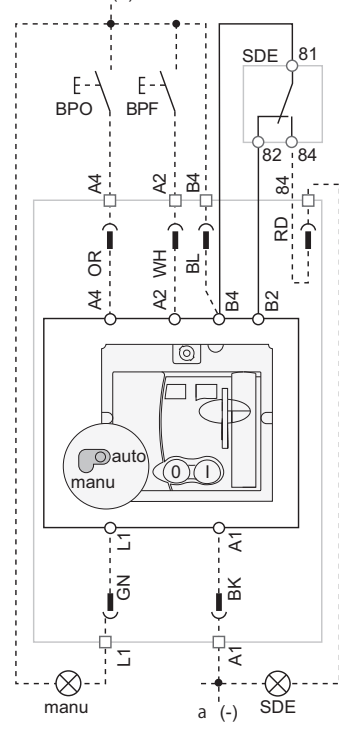
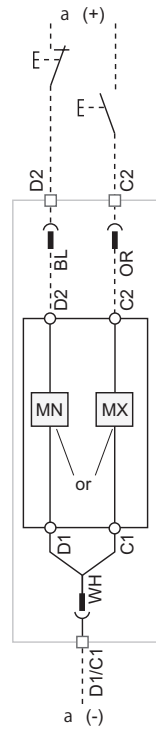
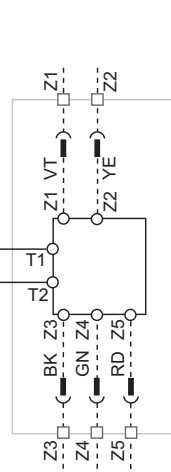

Motor mechanism (MT)

BX cord

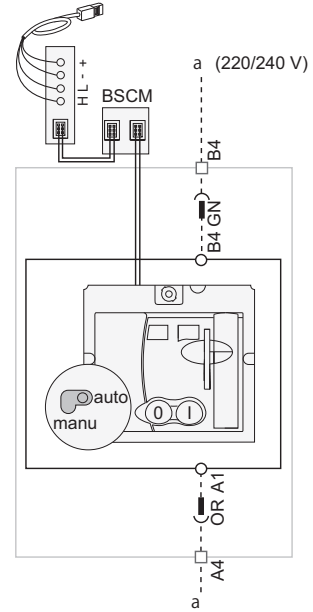

Communicating motor mechanism (MTc)

The diagram is shown with circuits de-energised, all devices open, connected and charged and relays in normal position.

Molded Case Circuit Breakers BX series (100AF to 630AF) Wiring diagrams

Indication contacts

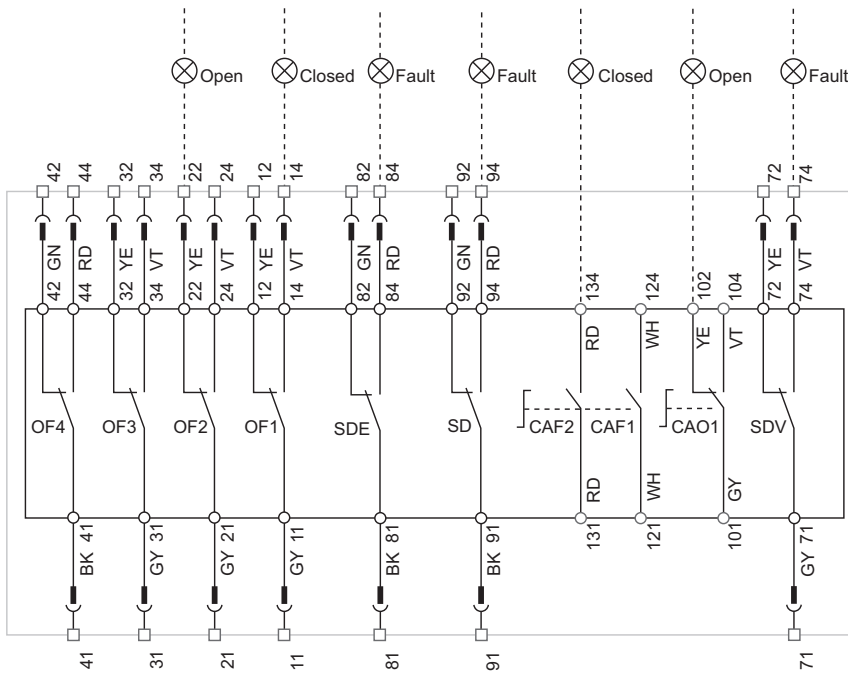

Carriage switches

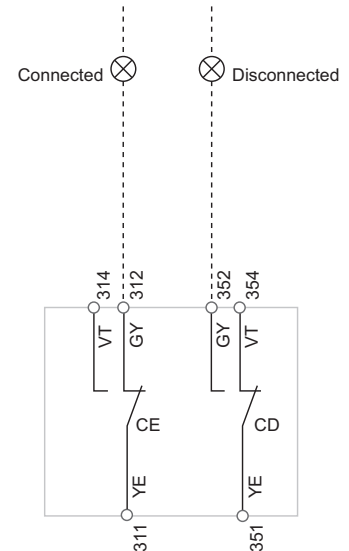

Control unit A or E

- A/E Communication**
H(WH), L(BL): data
- (BK), + (RD): 24 V DC power supply
-
- A/E ZSI (Zone Selective Interlocking)**
Z1: ZSI OUT SOURCE
Z2: ZSI OUT
Z3: ZSI IN SOURCE
Z4: ZSI IN ST (short time)
Z5: ZSI IN GF (ground fault)
Note: Z3, Z4, Z5 for BX400/630 only.
-
- A/E ENCT: external neutral current transformer:**
- shielded cable with 1 twisted pair (T1, T2)
- shielding earthed at one end only (CT end).
Connection L = 30 cm max.
- maximum length of 10 metres
- cable size 0.4 to 1.5 mm²
- recommended cable: Belden 8441 or equivalent.
-
- E ENVT: external neutral voltage tap for connection to the neutral via a 3P circuit breaker.**

Colour code for auxiliary wiring

- | | |
|-------------------|-------------------|
| RD: red | VT: violet |
| WH: white | GY: grey |
| YE: yellow | OR: orange |
| BK: black | BL: blue |
| GN: green | |

Terminals shown in red ∇ / ○ must be connected by the customer.

Remote operation

- MN:** undervoltage release
or
MX: shunt release

Motor mechanism (MT)

- A4:** opening order
A2: closing order
B4, A1: motor mechanism power supply
L1: manual position (manu)
B2: SDE interlocking (mandatory for automatic or remote recharging)
BPO: opening pushbutton
BPF: closing pushbutton

Communicating motor mechanism (MTc)

- B4, A1:** motor mechanism power supply
BSCM: breaker status and control module

Indication contacts

- OF2 / OF1:** device ON/OFF indication contacts
OF4 / OF3: device ON/OFF indication contacts (BX400/630)
SDE: fault-trip indication contact (short-circuit, overload, ground fault, earth leakage)
SD: trip-indication contact
CAF2/CAF1: early-make contact (rotary handle only)
CAO1: early-break contact (rotary handle only)

Molded Case Circuit Breakers BX series (100AF to 630AF) Wiring diagrams

■ BX100 to 630 Motor mechanism

The diagram is shown with circuits de-energised, all devices open, connected and charged and relays in normal position.

After tripping initiated by the "Push to trip" button or by the undervoltage (MN) release or the shunt (MX) release, device reset can be automatic, remote or manual.

Following tripping due to an electrical fault (with an SDE contact), reset must be carried out manually.

Motor mechanism (MT) with automatic reset

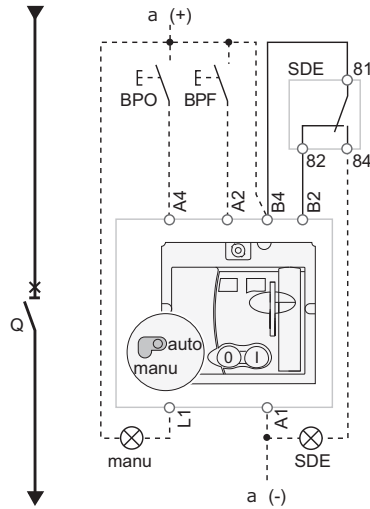

Motor mechanism (MT) with remote reset

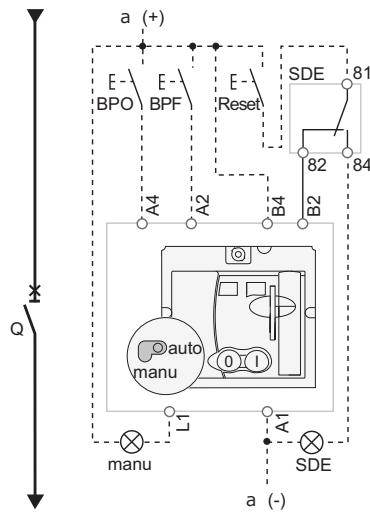

Motor mechanism (MT) with manual reset

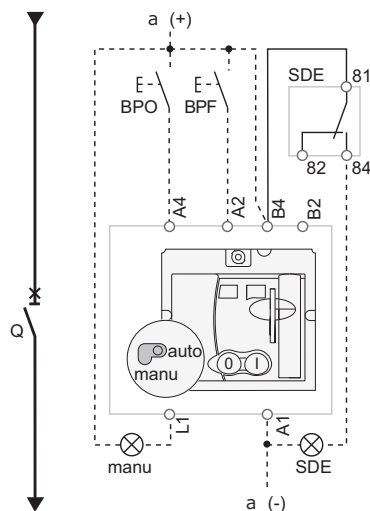

Symbols

- Q:** circuit breaker
- A4 :** opening order
- A2:** closing order
- B4, A1:** motor mechanism power supply
- L1:** manual position (manu)
- B2:** SDE interlocking (mandatory for correct operation)
- BPO:** opening pushbutton
- BPF:** closing pushbutton
- SDE:** fault-trip indication contact (short-circuit, overload, ground fault, earth leakage)

Molded Case Circuit Breakers BX series (100AF to 630AF) Wiring diagrams

Communicating motor mechanism (MTC)

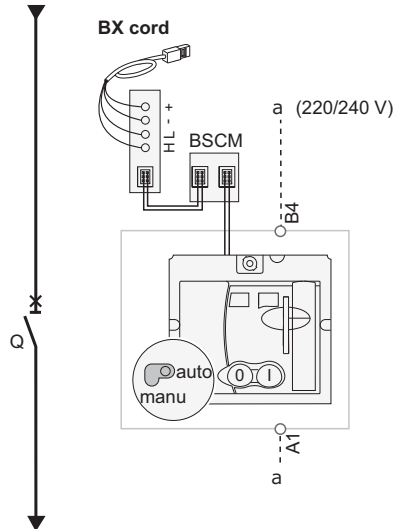

Schematic representation of the communicating motor mechanism (MT).

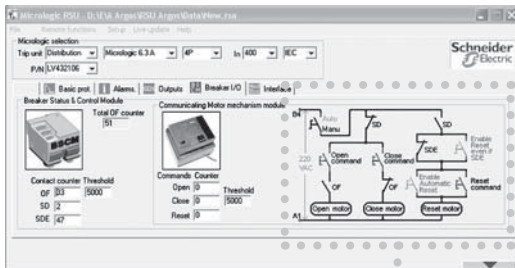

RSU utility setup screen for the communicating motor mechanism.

RSU screen for the communicating motor mechanism (MTC)

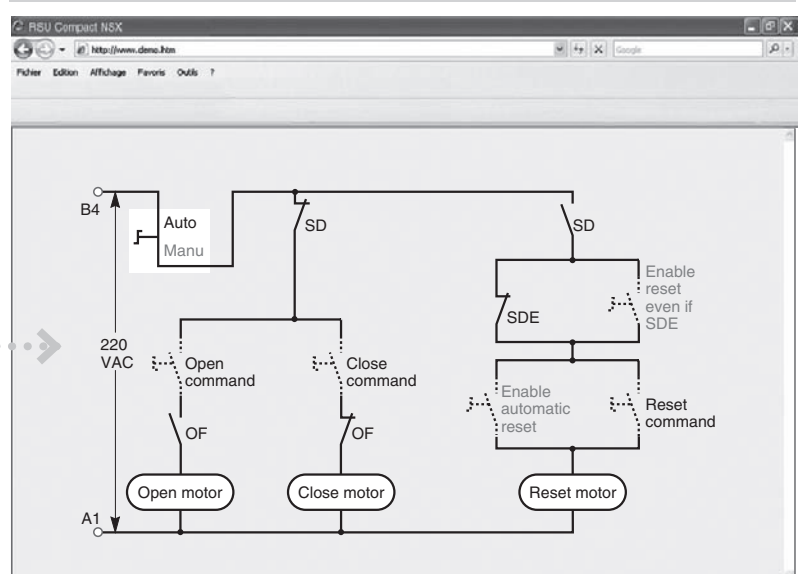

Single-line diagram of communicating motor mechanism

Opening, closing and reset orders are transmitted via the communication network. The "Enable automatic reset" and "Enable reset even if SDE" parameters must be set using the RSU software via the screen by clicking the blue text.

"Auto/manu" is a switch on the front of the motor mechanism.

Symbols

- Q:** circuit breaker
- B4, A1:** motor mechanism power supply
- BSCM:** breaker status and control module

Terminals shown in red **O** must be connected by the customer.

Molded Case Circuit Breakers BX series (100AF to 630AF) Wiring diagrams

■ BX100 to 630 SDx module with Control unit

The diagram is shown with circuits de-energised, all devices open, connected and charged and relays in normal position.

Symbols

SD1, SD3: SDx-module power supply

SD2: output 1 (80 mA max.)

SD4: output 2 (80 mA max.)

	SD2	SD4
Unit 2	SDT	-
Unit 5	SDT or output 1	PAL Ir or output 2
Unit 6	SDT or output 1	SDG or output 2

Terminals shown in red O must be connected by the customer.

Connection

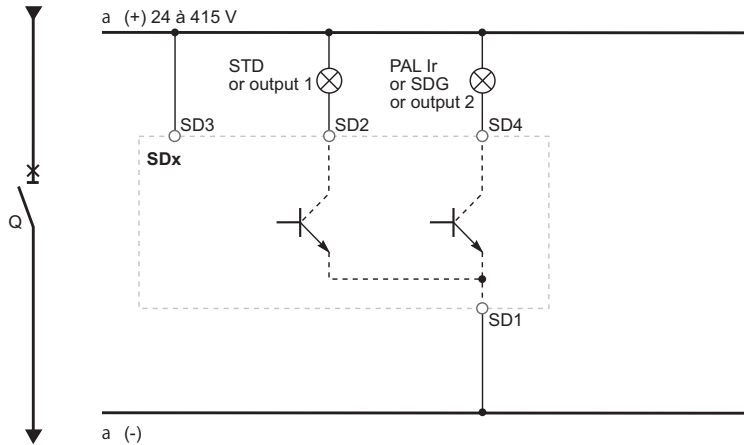

Operation

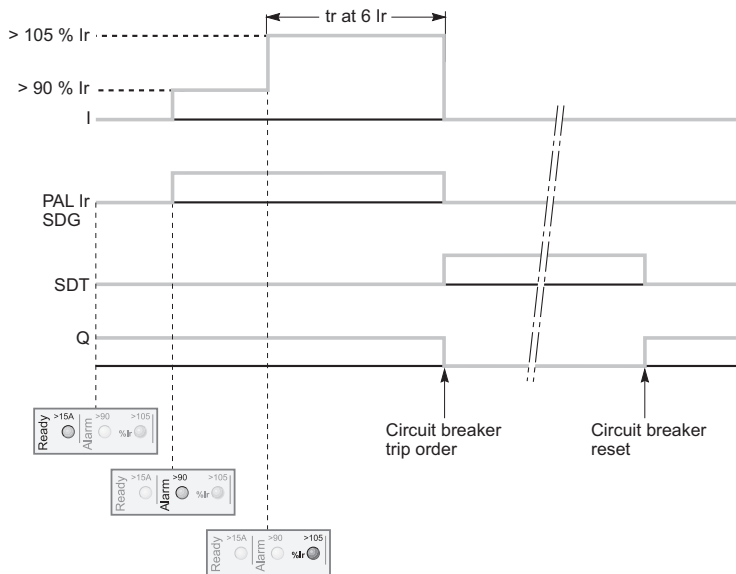

- I:** charge current
- PAL Ir:** thermal overload pre-alarm
- SDG:** ground-fault signal
- SDT:** thermal-fault signal
- Q:** circuit breaker

Molded Case Circuit Breakers BX series (100AF to 630AF) Wiring diagrams

Detailed connection of the circuit breakers on communication network Modbus.

Connection

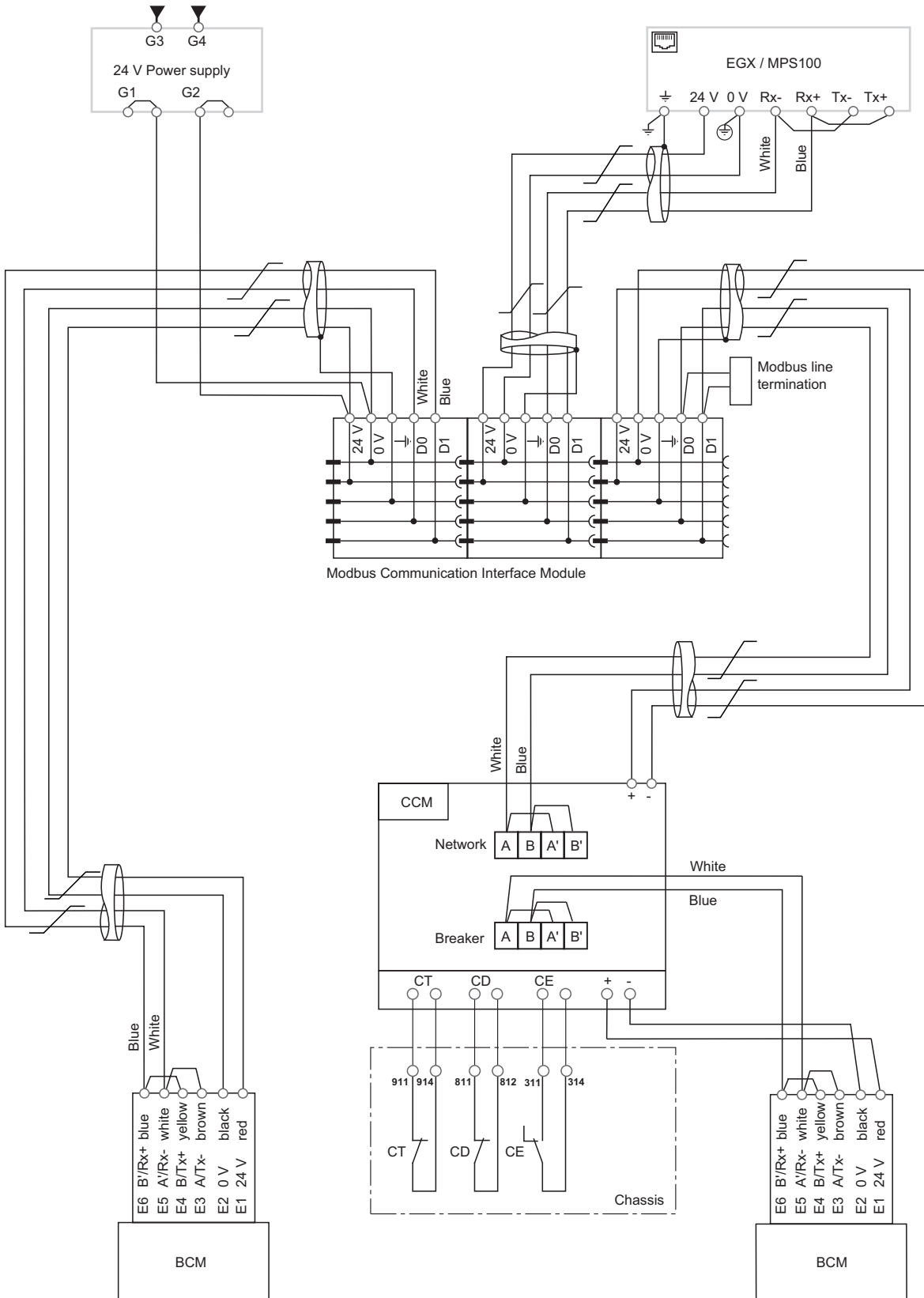

Molded Case Circuit Breakers BX series (100AF to 630AF) Tripping curves

■ Tripping curves

• BX100 to 250 Protection of distribution systems

TM magnetic trip units

TM16D

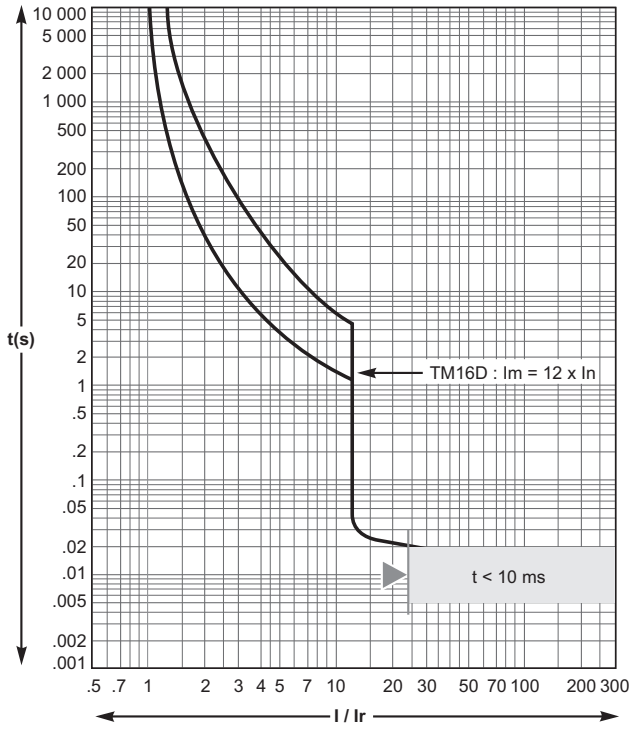

TM25D

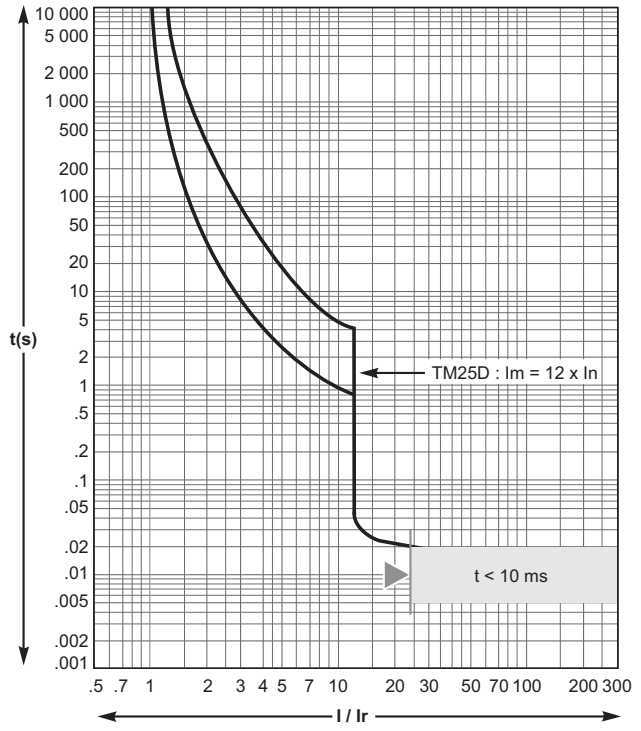

TM32D / TM40D

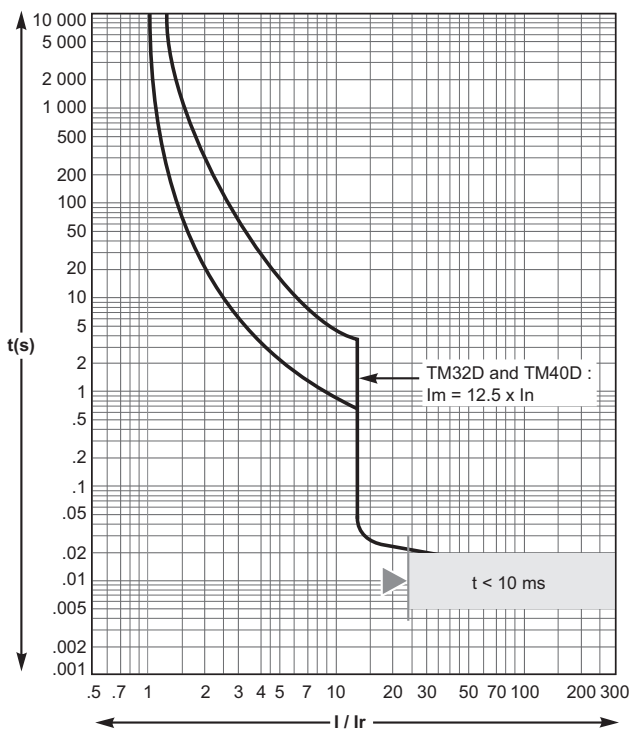

TM50D / TM63D

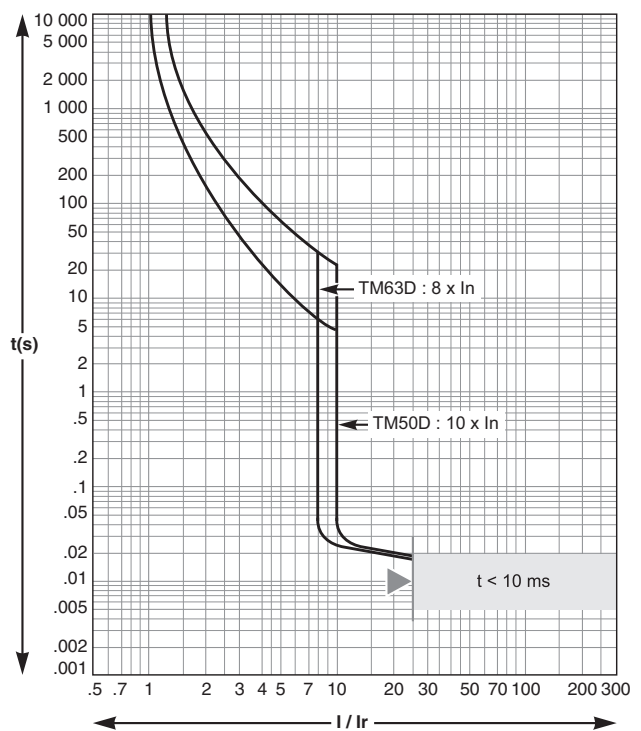

Molded Case Circuit Breakers BX series (100AF to 630AF) Tripping curves

TM magnetic trip units (cont.)

TM80D / TM100D

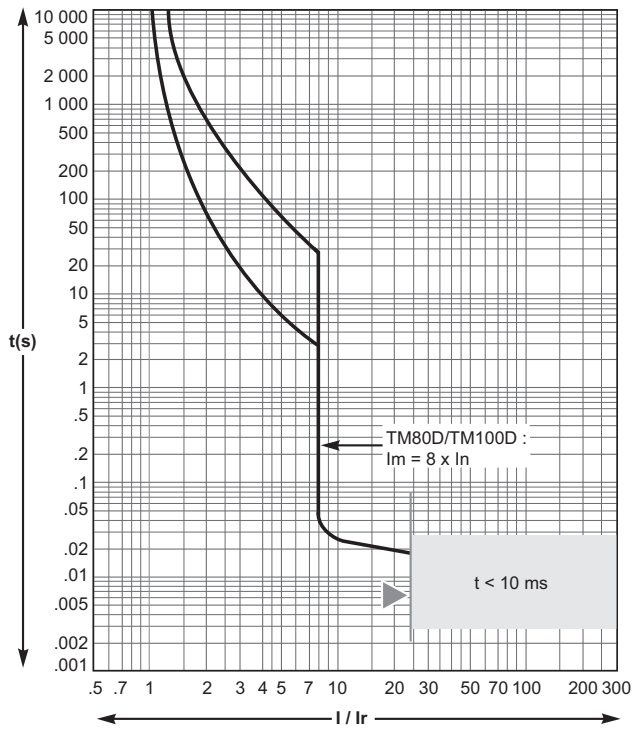

Reflex tripping.

TM125D / TM160D

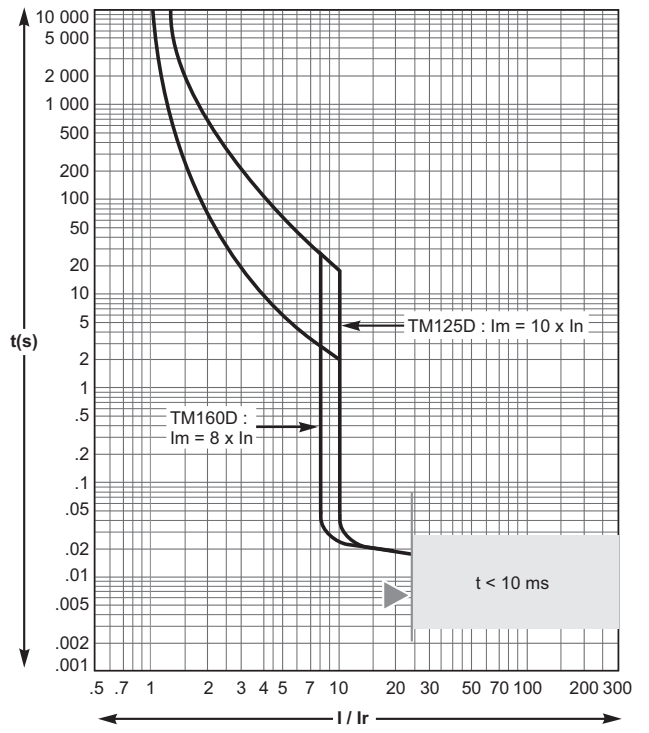

TM200D / TM250D

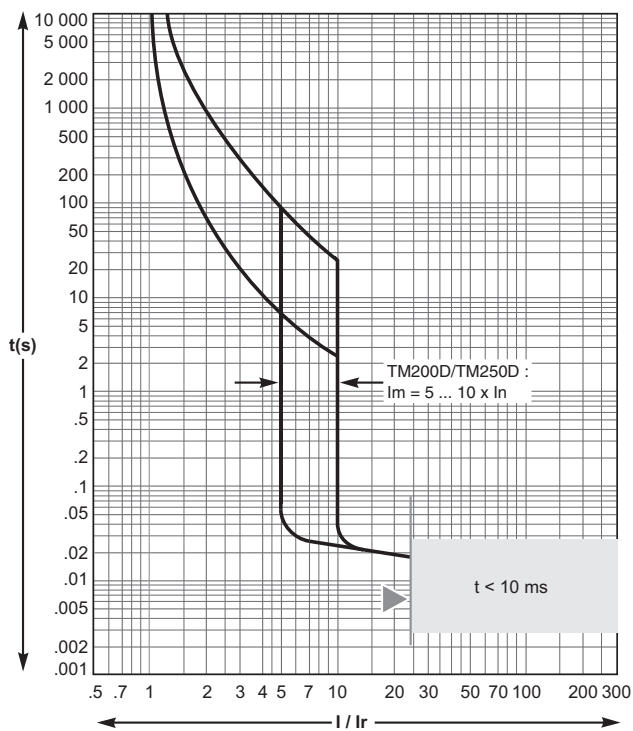

Reflex tripping.

Molded Case Circuit Breakers BX series (100AF to 630AF) Tripping curves

• BX100 to 250 Protection of distribution systems

Control unit 2

Unit 2 - 40... 160 A

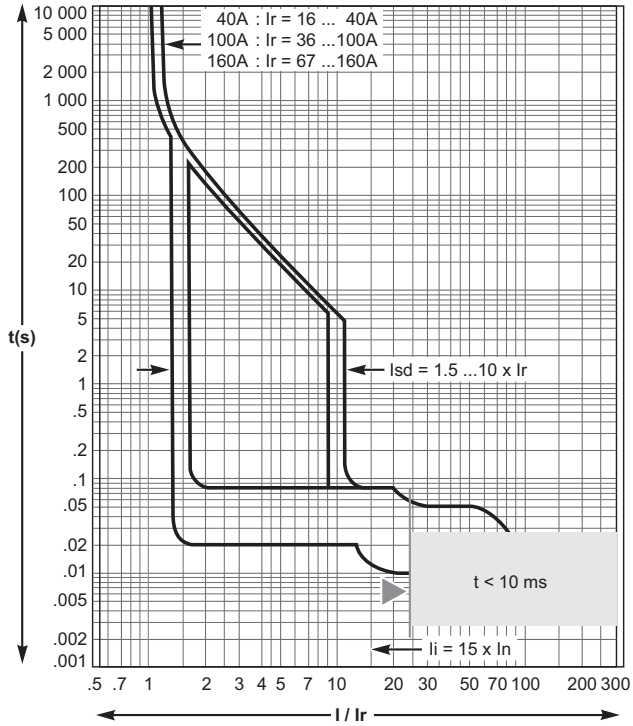

Reflex tripping.

Unit 2 - 250 A

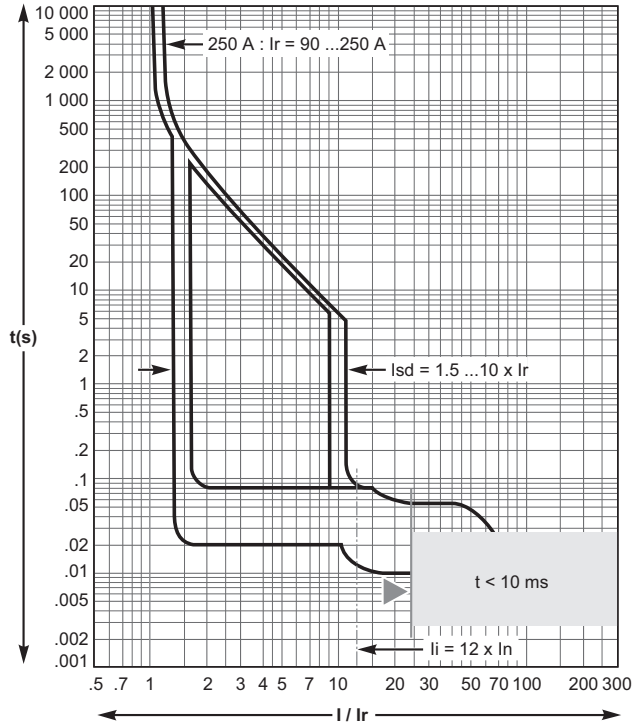

Molded Case Circuit Breakers BX series (100AF to 630AF) Tripping curves

Control unit 5A, 5E, 6A and 6E

Unit 5A, 6A, 5E and 6E - 40... 160 A

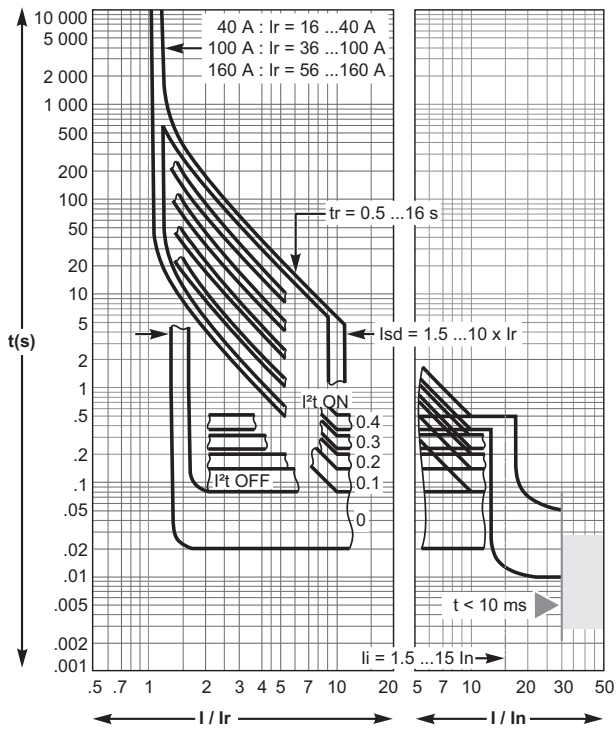

Reflex tripping.

Unit 5A, 6A, 5E and 6E - 250 A

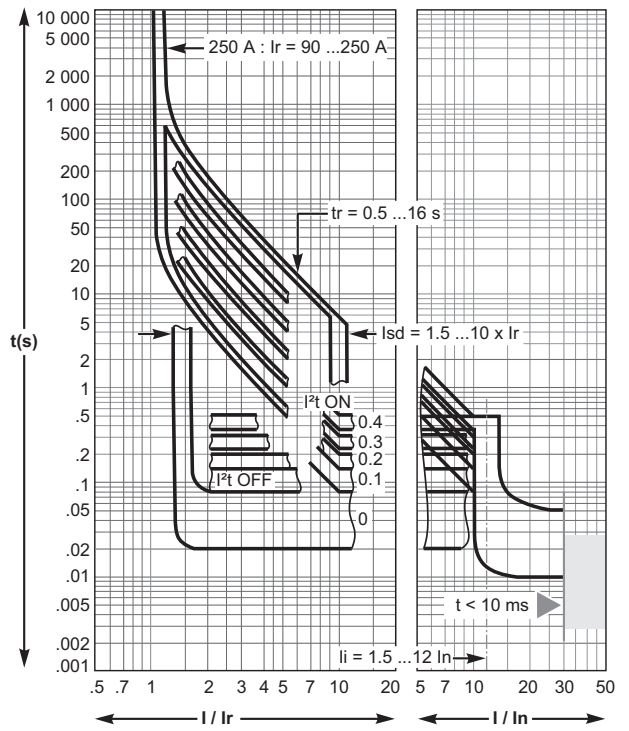

Unit 6A, 6E (ground-fault protection)

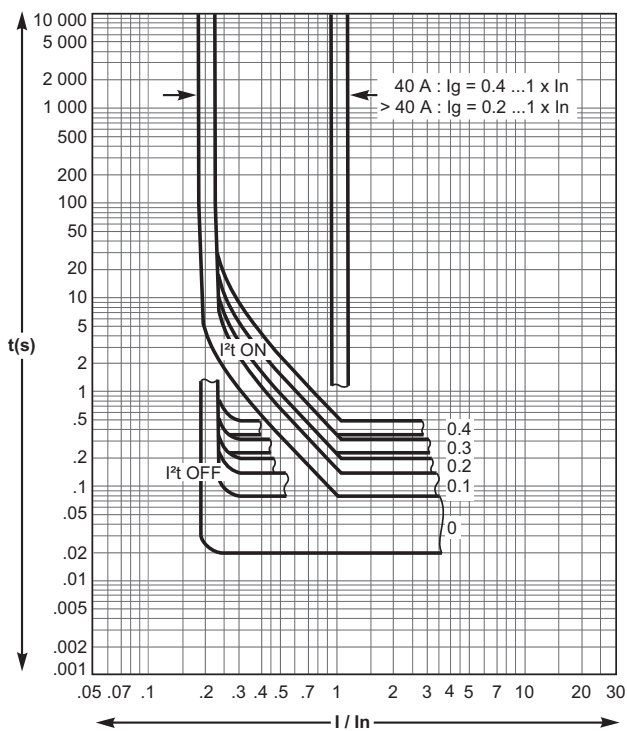

Molded Case Circuit Breakers BX series (100AF to 630AF) Tripping curves

• BX400 to 630 Protection of distribution systems

Control unit 2, 5 and 6A or E

Unit 2 - 250... 400 A

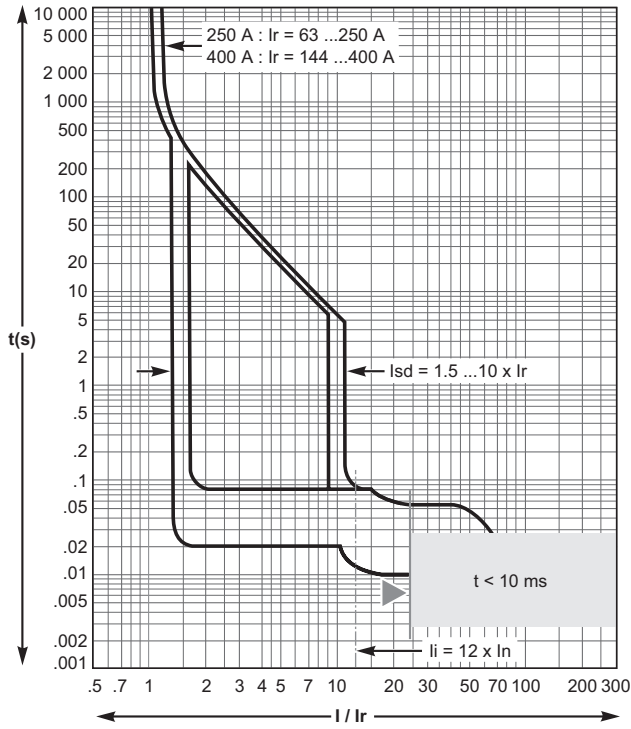

Reflex tripping.

Unit 2 - 630 A

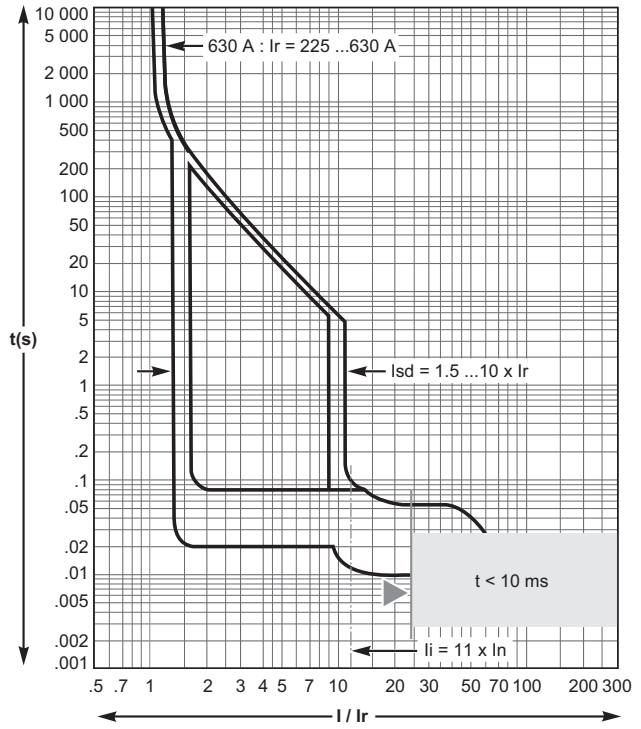

Unit 5 and 6 A or E - 400 A

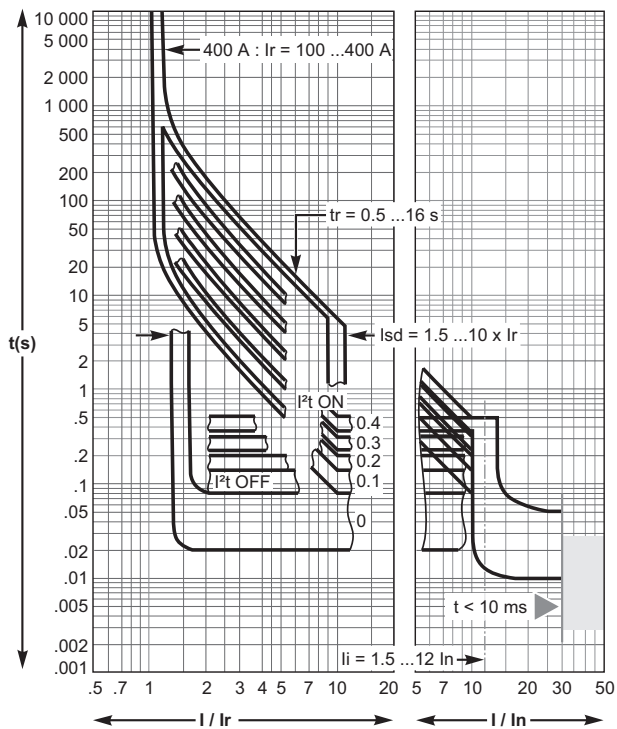

Reflex tripping.

Unit 5 and 6 A or E - 630 A

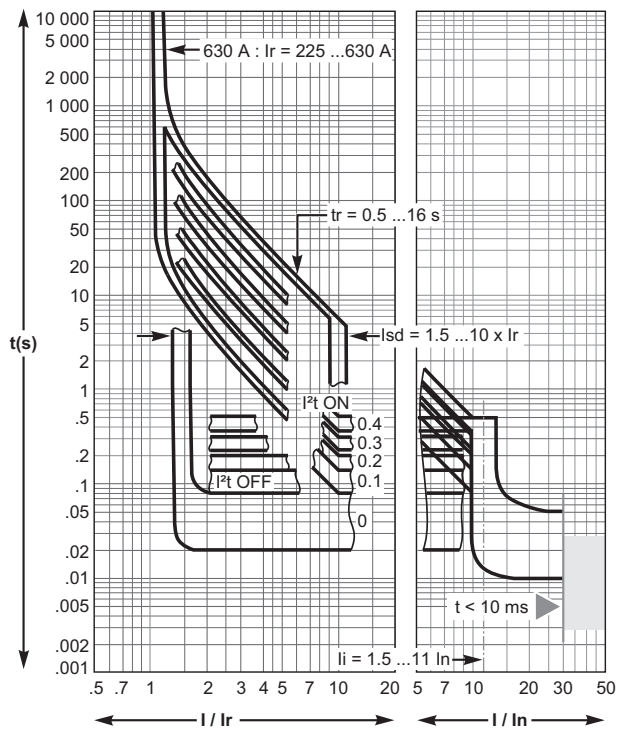

Molded Case Circuit Breakers
BX series (100AF to 630AF)
Tripping curves

Control unit 6A or E (cont.)

Unit 6 A or E (ground-fault protection)

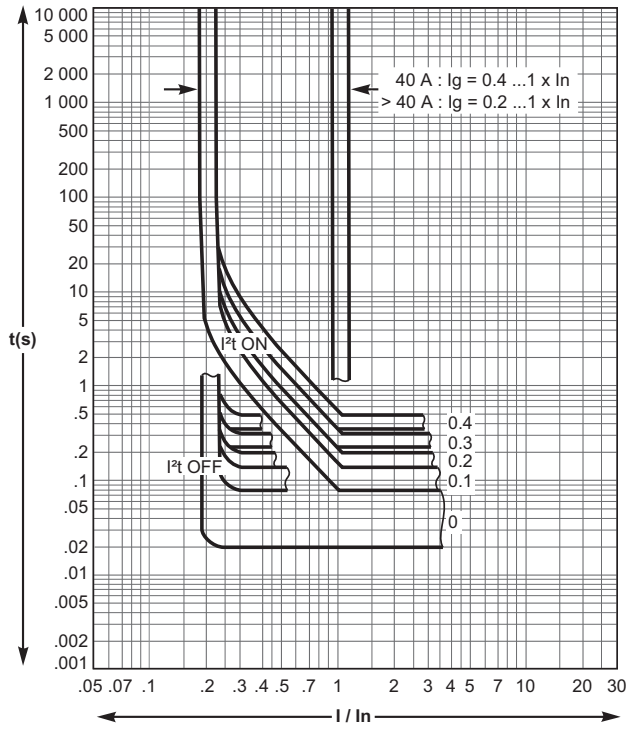

Molded Case Circuit Breakers BX series (100AF to 630AF) Tripping curves

• BX100 to 630 Reflex tripping

BX100 to 630 devices incorporate the exclusive reflex-tripping system.

This system breaks very high fault currents.

The device is mechanically tripped via a "piston" actuated directly by the pressure produced in the breaking units by the short-circuit.

For high short-circuits, this system provides a faster break, thereby ensuring discrimination.

Reflex-tripping curves are exclusively a function of the circuit-breaker rating.

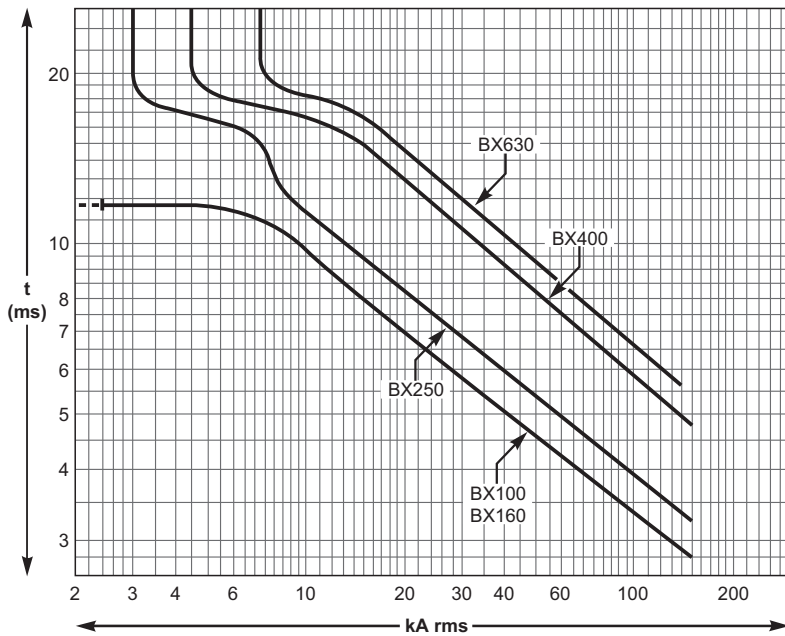

Molded Case Circuit Breakers BX series (100AF to 630AF) Tripping curves

■ Current and energy limiting curves

Ics = 100 % Icu

The exceptional limiting capacity of the BX range greatly reduces the forces created by fault currents in devices. The result is a major increase in breaking performance.

In particular, the service breaking capacity Ics is equal to 100 % of Icu.

The Ics value, defined by IEC standard 60947-2, is guaranteed by tests comprising the following steps:

- break three times consecutively a fault current equal to 100 % of Icu
- check that the device continues to function normally, that is:
 - it conducts the rated current without abnormal temperature rise
 - protection functions perform within the limits specified by the standard
 - suitability for isolation is not impaired.

Longer service life of electrical installations

Current-limiting circuit breakers greatly reduce the negative effects of short-circuits on installations.

Thermal effects

Less temperature rise in conductors, therefore longer service life for cables.

Mechanical effects

Reduced electrodynamic forces, therefore less risk of electrical contacts or busbars being deformed or broken.

Electromagnetic effects

Fewer disturbances for measuring devices located near electrical circuits.

Economy by means of cascading

Cascading is a technique directly derived from current limiting. Circuit breakers with breaking capacities less than the prospective short-circuit current may be installed downstream of a limiting circuit breaker. The breaking capacity is reinforced by the limiting capacity of the upstream device. It follows that substantial savings can be made on downstream equipment and enclosures.

Current and energy limiting curves

The limiting capacity of a circuit breaker is expressed by two curves which are a function of the prospective short-circuit current (the current which would flow if no protection devices were installed):

- the actual peak current (limited current)
- thermal stress (A^2s), i.e. the energy dissipated by the short-circuit in a conductor with a resistance of 1Ω .

Example

What is the real value of a 150 kA rms prospective short-circuit (i.e. 330 kA peak) limited by an BX250L upstream ?
The answer is 30 kA peak (curve page 84).

Maximum permissible cable stresses

The table below indicates the maximum permissible thermal stresses for cables depending on their insulation, conductor (Cu or Al) and their cross-sectional area (CSA). CSA values are given in mm^2 and thermal stresses in A^2s .

CSA		1.5 mm ²	2.5 mm ²	4 mm ²	6 mm ²	10 mm ²
PVC	Cu	2.97x10 ⁴	8.26x10 ⁴	2.12x10 ⁵	4.76x10 ⁵	1.32x10 ⁶
	Al					5.41x10 ⁵
PRC	Cu	4.10x10 ⁴	1.39x10 ⁵	2.92x10 ⁵	6.56x10 ⁵	1.82x10 ⁶
	Al					7.52x10 ⁵
CSA		16 mm ²	25 mm ²	35 mm ²	50 mm ²	
PVC	Cu	3.4x10 ⁶	8.26x10 ⁶	1.62x10 ⁷	3.31x10 ⁷	
	Al	1.39x10 ⁶	3.38x10 ⁶	6.64x10 ⁶	1.35x10 ⁷	
PRC	Cu	4.69x10 ⁶	1.39x10 ⁷	2.23x10 ⁷	4.56x10 ⁷	
	Al	1.93x10 ⁶	4.70x10 ⁶	9.23x10 ⁶	1.88x10 ⁷	

Example

Is a Cu/PVC cable with a CSA of 10 mm² adequately protected by an BX160F?

The table above indicates that the permissible stress is 1.32x10⁶ A²s.

All short-circuit currents at the point where an BX160F (Icu = 35 kA) is installed are limited with a thermal stress less than 6x10⁵ A²s (curve page 84).

Cable protection is therefore ensured up to the limit of the breaking capacity of the circuit breaker.

The limiting capacity of a circuit breaker is its aptitude to let through a current, during a short-circuit, that is less than the prospective short-circuit current.

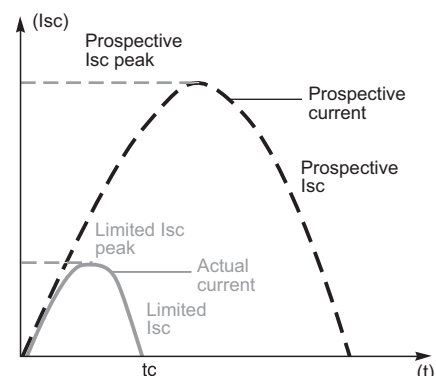

The exceptional limiting capacity of the BX range is due to the rotating double-break technique (very rapid natural repulsion of contacts and the appearance of two arc voltages in-series with a very steep wave front).

Molded Case Circuit Breakers BX series (100AF to 630AF) Tripping curves

■ Current and energy limiting curves

Current-limiting curves

Voltage 400/440 V AC

Limited short-circuit current (kA peak)

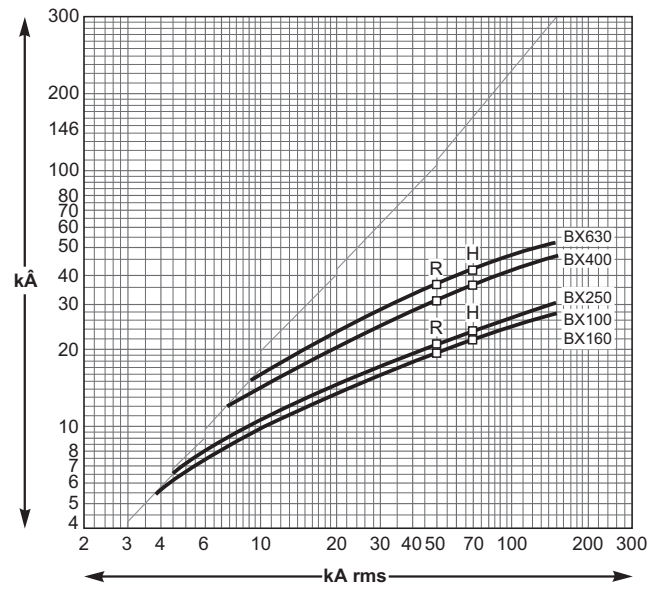

Voltage 660/690 V AC

Limited short-circuit current (kA peak)

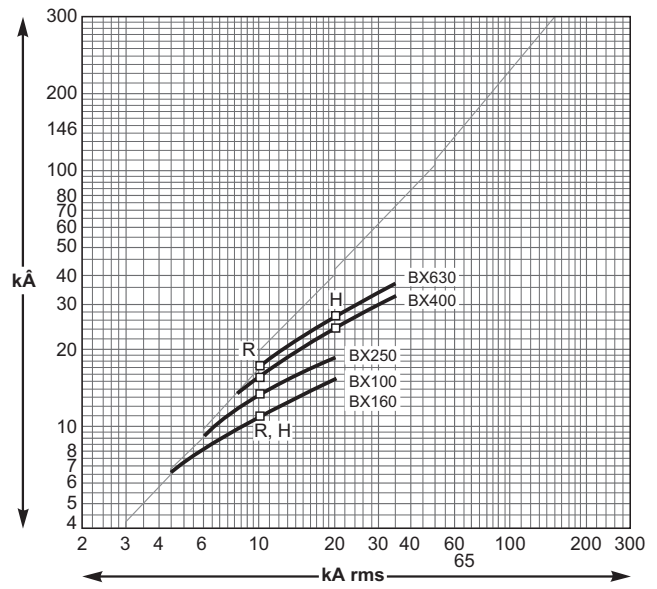

Molded Case Circuit Breakers BX series (100AF to 630AF) Tripping curves

Energy-limiting curves

Voltage 400/440 V AC

Limited energy

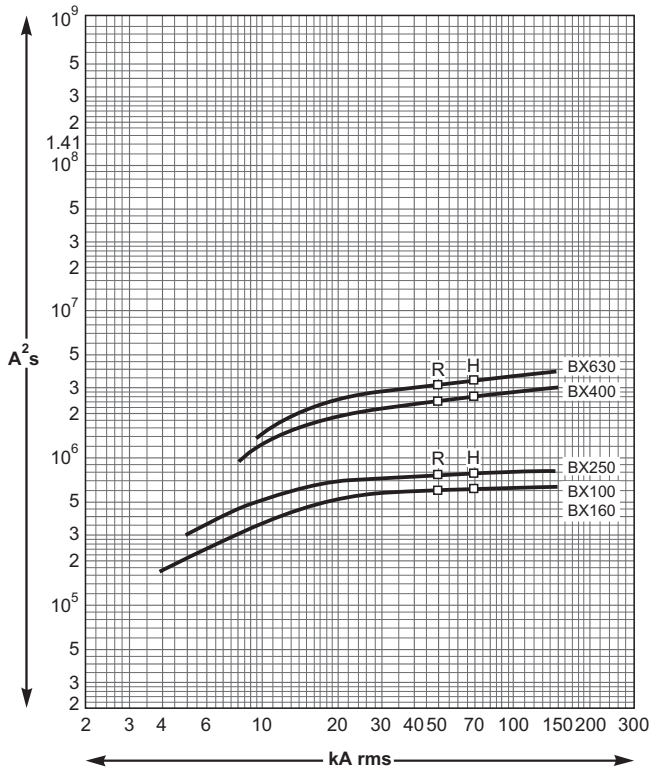

Voltage 660/690 V AC

Limited energy

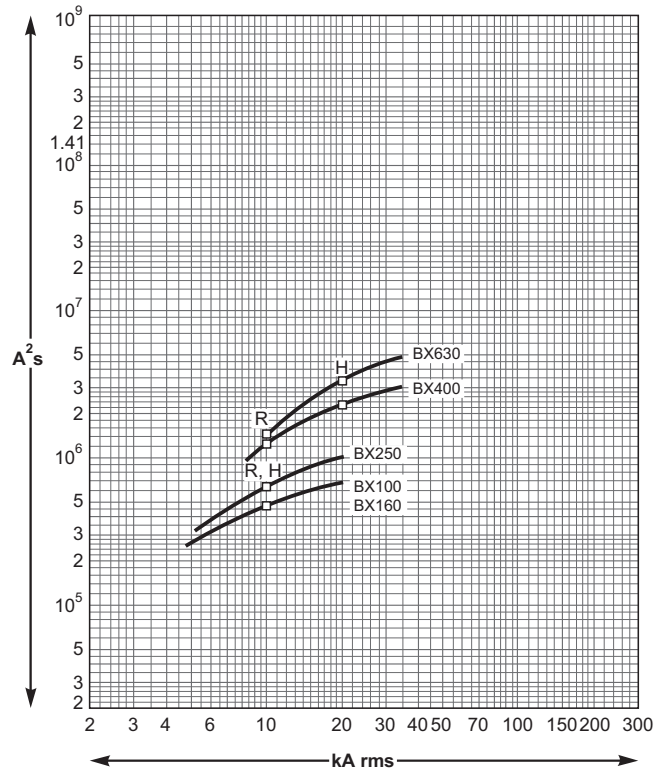

Molded Case Circuit Breakers

BX series (800AF to 1600AF)

Protection of distribution systems

■ BX circuit breakers from 800 to 1600 A

Type				BX800		BX1000		BX1250		BX1600	
Number of poles				3, 4		3, 4		3, 4		3, 4	
Control	Manual	Toggle	●	●	●	●	●	●	●	●	
		Direct or extended rotary handle	●	●	●	●	●	●	●	●	
	Electric	●	●	●	●	●	●	●	●	●	
Type of circuit breaker				R	H	R	H	R	H	R	H
Connections	Fixed	Front connection	●	●	●	●	●	●	●	●	
		Rear connection	●	●	●	●	●	●	●	●	
		Front connection with bare cables	●	●	●	●	●	●	●	●	
	withdrawable (on chassis)	Front connection	●	●	●	●	●	●	●	●	
		Rear connection	●	●	●	●	●	●	●	●	
			●	●	●	●	●	●	●	●	
Electrical characteristics as per Nema AB1				R	H	R	H	R	H	R	H
Breaking capacity at 60 Hz (kA)			240V	50	65	50	65	50	65	50	65
			480V	35	50	35	50	35	50	35	50
			600V	25	50	25	50	25	50	25	50
Electrical characteristics as per IEC 60947-2 and EN 60947-2											
Rated current (A)	In	50°C	630		1000		1250		1600		
		65°C ⁽¹⁾	630		1000		1250		1510		
Rated insulation voltage (V)	Ui	800		800		800		800			
Rated impulse withstand voltage (kV)	Uimp	8		8		8		8			
Rated operational voltage (V)	Ue	AC 50/60Hz		690		690		690		690	
Ultimate breaking capacity (kA rms)	Manual Icu	AC 50/60Hz	220/240V	85	85	85	85	85	85	85	85
			380/415V	50	70	50	70	50	70	50	70
			440V	50	65	50	65	50	65	50	65
			500V/525V	40	50	40	50	40	50	40	50
			660/690V	30	42	30	42	30	42	30	42
	Manual Ics	AC 50/60Hz	220/240V	50	52	50	52	50	52	37	37
			380/415V	50	52	50	52	50	52	37	37
			440V	50	48	50	48	50	48	37	32
			500V/525V	40	37	40	37	40	37	30	25
			660/690V	30	31	30	31	30	31	22	21
	Electrical Icu	AC 50/60Hz	220/240V	50	70	50	70	50	70	50	70
			380/415V	50	70	50	70	50	70	50	70
			440V	50	65	50	65	50	65	50	65
			500V/525V	40	50	40	50	40	50	40	50
			660/690V	30	42	30	42	30	42	30	42
	Electrical Ics	AC 50/60Hz	220/240V	37	35	37	35	37	35	37	35
			380/415V	37	35	37	35	37	35	37	35
			440V	37	32	37	32	37	32	37	32
			500V/525V	30	25	30	25	30	25	30	25
			660/690V	22	21	22	21	22	21	22	21
Short-time withstand current (kA rms)	Icw	AC 50/60Hz	1s	19.2		19.2		19.2		19.2	
			3s	-		-		-		-	
Integrated instantaneous protection	kA peak ±10 %		40		40		40		40		
Suitability for isolation			●		●		●		●		
Utilisation category			B		B		B		B		
Durability (C-O cycles)	Mechanical		10000		10000		10000		10000		
	Electrical	440V	In/2	6000	6000	5000	5000				
			In	5000	5000	4000	2000				
		690V	In/2	4000	4000	3000	2000				
			In	2000	2000	2000	2000				
Pollution degree			3		3		3		3		

**Molded Case Circuit Breakers
BX series (800AF to 1600AF)
Protection of distribution systems**

Circuit breakers			BX800, BX1000, BX1250, BX1600												
Protection and measurements			Control unit												
Interchangeable control units			2.0	5.0	6.0	2.0 A	5.0 A	6.0 A	7.0 A	2.0 E	5.0 E	6.0 E	5.0 P	6.0 P	7.0 P
Overload protection	long time	$I_r (I_n \times \dots)$	●	●	●	●	●	●	●	●	●	●	●	●	●
Short-circuit protection	short time	$I_{sd} (I_r \times \dots)$	-	●	●	-	●	●	●	-	●	●	●	●	●
	instantaneous	$I_i (I_n \times \dots)$	●	●	●	●	●	●	●	●	●	●	●	●	●
Earth-fault protection		$I_g (I_n \times \dots)$	-	-	●	-	-	-	-	-	-	-	-	●	-
Residual earth-leakage protection		$I_{\Delta n}$	-	-	-	-	-	-	●	-	-	-	-	-	●
Zone selective interlocking		ZSI	-	-	-	●	●	●	●	●	●	●	●	●	●
Protection of the fourth pole			●	●	●	●	●	●	●	●	●	●	●	●	●
Current measurements			-	-	-	●	●	●	●	●	●	●	●	●	●
Power measurements			-	-	-	-	-	-	-	●	●	●	●	●	●
Advanced protection			-	-	-	-	-	-	-	-	-	-	●	●	●
Quick view			-	-	-	-	-	-	-	●	●	●	-	-	-
Remote communication by bus															
Device-status indication			●	●	●	●	●	●	●	●	●	●	●	●	●
Device remote operation (2)			●	●	●	●	●	●	●	●	●	●	●	●	●
Transmission of settings			-	-	-	●	●	●	●	●	●	●	●	●	●
Indication and identification of protection devices and alarms			-	-	-	●	●	●	●	●	●	●	●	●	●
Transmission of measured current values			-	-	-	●	●	●	●	●	●	●	●	●	●

Circuit breakers		BX800, BX1000, BX1250, BX1600	
Additional indication and control auxiliaries			
Indication contacts			●
Voltage releases	MX shunt release/MN undervoltage release		●
Installation			
Accessories	terminal extensions and spreaders		●
	terminal shields and interphase barriers		●
	escutcheons		●
Dimensions fixed devices, front connections (mm)	3P	327 x 210 x 147	
H x W x D	4P	327 x 280 x 147	
Mass fixed devices, front connections (kg)	3P	14	
	4P	18	
Source changeover system (see section on "source changeover systems")			
Manual, remote-operated and automatic source changeover systems		b	

(1) With BX800...BX1600, remote operation is possible with electrically operated device.

Molded Case Circuit Breakers BX series (800AF to 1600AF) Control units

Overview of functions

Dependability

Integration of protection functions in an ASIC electronic component used in all control units guarantees a high degree of reliability and immunity to conducted or radiated disturbances.

On A, E and P control units, advanced functions are managed by an independent microprocessor.

Accessories

Certain functions require the addition of control unit accessories, described on page 105.

Name codes

2.0 E
X Y Z

X: type of protection

- 2 for basic protection
- 5 for selective protection
- 6 for selective + earth-fault protection
- 7 for selective + earth-leakage protection.

Y: control-unit generation

identification of the control-unit generation.
"0" signifies the first generation.

Z: type of measurement

- A for "ammeter"
- E for "energy"
- P for "power meter"



All circuit breakers are equipped with a control unit that can be changed on site.

Control units are designed to protect Power circuits and loads. Alarms may be programmed for remote indications.

Measurements of current, voltage, frequency, power and power quality optimise continuity of service and energy management.

Current protection

2: basic protection

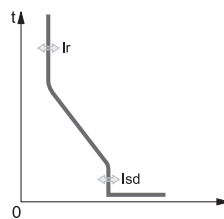

Protection:
long time
+ instantaneous

5: selective protection

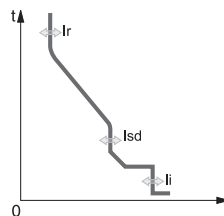

Protection:
long time
+ short time
+ instantaneous

6: selective + earth-fault protection

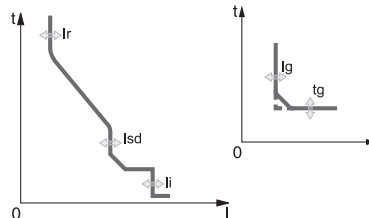

Protection:
long time
+ short time
+ instantaneous
+ earth fault

7: selective + earth-leakage protection

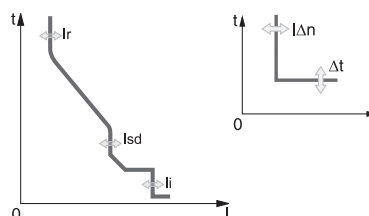

Protection:
long time
+ short time
+ instantaneous
+ earth leakage up to 3200A

Molded Case Circuit Breakers
BX series (800AF to 1600AF)
Control units

Without measurement	Measurements and programmable protection		
	<p>A: ammeter</p> <ul style="list-style-type: none"> ■ $I_1, I_2, I_3, I_N, I_{\text{earth-fault}}, I_{\text{earth-leakage}}$ and maximeter for these measurements ■ fault indications ■ settings in amperes and in seconds. <p>E: Energy</p> <ul style="list-style-type: none"> ■ incorporates all the rms measurements of A, plus voltage, power factor, power and energy metering measurements. □ calculates the current demand value □ "Quickview" function for the automatic cyclical display of the most useful values (as standard or by selection). <p>P: A + power meter + programmable protection</p> <ul style="list-style-type: none"> ■ measurements of V, A, W, VAR, VA, Wh, VARh, VAh, Hz, Vpeak, Apeak, power factor and maximeters and minimeters ■ IDMTL long-time protection, minimum and maximum voltage and frequency, voltage and current imbalance, phase sequence, reverse power ■ load shedding and reconnection depending on power or current ■ measurements of interrupted currents, differentiated fault indications, maintenance indications, event histories and time-stamping, etc. 		

2.0



2.0A



2.0E



5.0



5.0A



5.0E



5.0P



6.0



6.0A



6.0E



6.0P



7.0A



7.0P



Molded Case Circuit Breakers

BX series (800AF to 1600AF)

Control units

■ For BX800 to 1600

Protection

Protection thresholds and delays are set using the adjustment dials.

Overload protection

True rms long-time protection.

Thermal memory: thermal image before and after tripping.

Setting accuracy may be enhanced by limiting the setting range using a different long-time rating plug.

Overload protection can be cancelled using a specific LT rating plug "Off".

Short-circuit protection

Short-time (rms) and instantaneous protection.

Selection of I_{2t} type (ON or OFF) for short-time delay.

Earth-fault protection

Residual or source ground return earth fault protection.

Selection of I_{2t} type (ON or OFF) for delay.

Neutral protection

On three-pole circuit breakers, neutral protection is not possible.

On four-pole circuit breakers, neutral protection may be set using a three-position switch: neutral unprotected (4P 3d), neutral protection at 0.5 I_r (4P 3d + N/2) or neutral protection at I_r (4P 4d).

Indications

Overload indication by alarm LED on the front; the LED goes on when the current exceeds the long-time trip threshold.

Test

A mini test kit or a portable test kit may be connected to the test connector on the front to check circuit-breaker operation after installing the trip unit or accessories.

Fault indications (only for Control unit 6.0)

LEDs indicate the type of fault:

- overload (long-time protection I_r)
- short-circuit (short-time I_{sd} or instantaneous I_i protection)
- earth fault or earth leakage (I_g)
- internal fault (A_p).

Battery power

The fault indication LEDs remain on until the test/reset button is pressed. Under normal operating conditions, the battery supplying the LEDs has a service life of approximately 10 years.

2.0, 5.0 and 6.0 control units protect power circuits. 5.0 and 6.0 offers time discrimination for short-circuits as well.

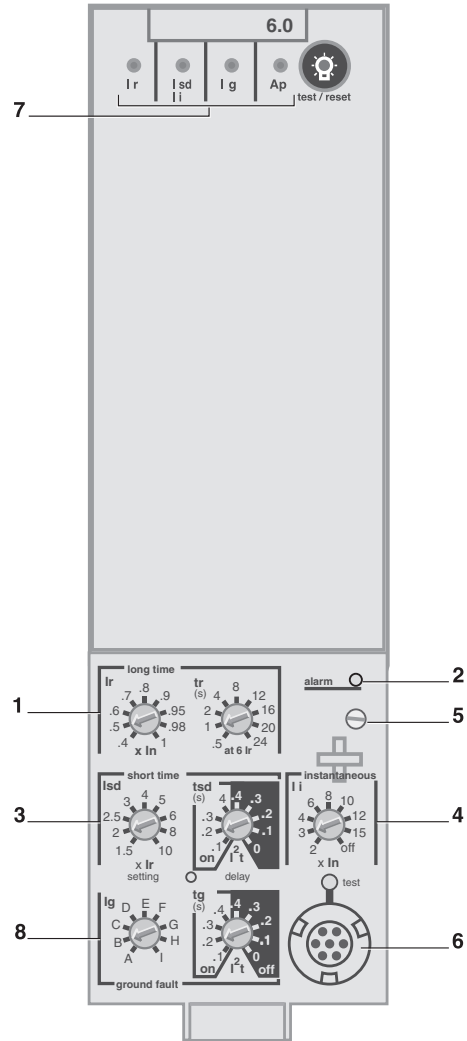

- 1 long-time threshold and tripping delay
- 2 overload alarm (LED)
- 3 short-time pick-up and tripping delay
- 4 instantaneous pick-up
- 5 fixing screw for long-time rating plug
- 6 test connector
- 7 indication of tripping cause
- 8 earth-leakage or earth-fault pick-up and tripping delay

Note: Control units are equipped with a transparent lead-seal cover as standard.

Molded Case Circuit Breakers BX series (800AF to 1600AF) Control units

Protection		2.0									
Long time											
Current setting (A)	$I_r = I_n \times \dots$	0.4	0.5	0.6	0.7	0.8	0.9	0.95	0.98	1	
Tripping between 1.05 and 1.20 x I_r		other ranges or disable by changing long-time rating plug									
Time setting	t (s)	0.5	1	2	4	8	12	16	20	24	
Time delay (s)	accuracy: 0 to -30 %	$1.5 \times I_r$	12.5	25	50	100	200	300	400	500	600
	accuracy: 0 to -20 %	$6 \times I_r$	0.7 ⁽¹⁾	1	2	4	8	12	16	20	24
	accuracy: 0 to -20 %	$7.2 \times I_r$	0.7 ⁽²⁾	0.69	1.38	2.7	5.5	8.3	11	13.8	16.6
Thermal memory		20 minutes before and after tripping									
(1) 0 to -40 % - (2) 0 to -60 %											
Instantaneous											
Pick-up (A)	$I_{sd} = I_r \times \dots$	1.5	2	2.5	3	4	5	6	8	10	
Accuracy: ± 10 %											
Time delay		max. resettable time: 20 ms; max break time: 80 ms									

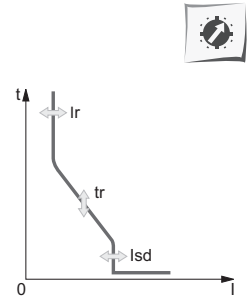

Protection		5.0 / 6.0									
Long time											
Current setting (A)	$I_r = I_n \times \dots$	0.4	0.5	0.6	0.7	0.8	0.9	0.95	0.98	1	
Tripping between 1.05 and 1.20 x I_r		Other ranges or disable by changing long-time rating plug									
Time setting	t_r (s)	0.5	1	2	4	8	12	16	20	24	
Time delay (s)	Accuracy: 0 to -30 %	$1.5 \times I_r$	12.5	25	50	100	200	300	400	500	600
	Accuracy: 0 to -20 %	$6 \times I_r$	0.7 ⁽¹⁾	1	2	4	8	12	16	20	24
	Accuracy: 0 to -20 %	$7.2 \times I_r$	0.7 ⁽²⁾	0.69	1.38	2.7	5.5	8.3	11	13.8	16.6
Thermal memory		20 minutes before and after tripping									
(1) 0 to -40 % - (2) 0 to -60 %											
Short time											
Pick-up (A)	$I_{sd} = I_r \times \dots$	1.5	2	2.5	3	4	5	6	8	10	
Accuracy: ± 10 %											
Time setting t_{sd} (s)	Settings	I^2t Off	0	0.1	0.2	0.3	0.4				
		I^2t On	-	0.1	0.2	0.3	0.4				
Time delay (ms) at 10 x I_r (I^2t Off or I^2t On)	t_{sd} (max resettable time)	20	80	140	230	350					
	t_{sd} (max break time)	80	140	200	320	500					
Instantaneous											
Pick-up (A)	$I_i = I_n \times \dots$	2	3	4	6	8	10	12	15	off	
Accuracy: ± 10 %											
Time delay		Max resettable time: 20 ms Max break time: 50 ms									
Earth fault											
Pick-up (A)	$I_g = I_n \times \dots$	A	B	C	D	E	F	G	H	J	
Accuracy: ± 10 %	$I_n \leq 400$ A	0.3	0.3	0.4	0.5	0.6	0.7	0.8	0.9	1	
	400 A < I_n < 1250 A	0.2	0.3	0.4	0.5	0.6	0.7	0.8	0.9	1	
	$I_n \geq 1250$ A	500	640	720	800	880	960	1040	1120	1200	
Time setting t_g (s)	Settings	I^2t Off	0	0.1	0.2	0.3	0.4				
		I^2t On	-	0.1	0.2	0.3	0.4				
Time delay (ms) at I_n or 1200 A (I^2t Off or I^2t On)	t_g (max resettable time)	20	80	140	230	350					
	t_g (max break time)	80	140	200	320	500					

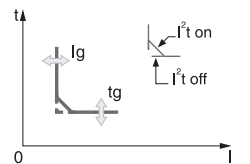
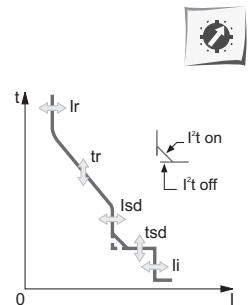

Note: all current-based protection functions require no auxiliary source.
The test / reset button resets maximeters, clears the tripping indication and tests the battery.

Molded Case Circuit Breakers

BX series (800AF to 1600AF)

Control units

■ A "ammeter"

"Ammeter" measurements

A control units measure the true (rms) value of currents. They provide continuous current measurements from 0.2 to 1.2 In and are accurate to within 1.5 % (including the sensors). A digital LCD screen continuously displays the most heavily loaded phase (Imax) or displays the I_1 , I_2 , I_3 , I_N , I_g , $I_{\Delta n}$, stored-current (maximeter) and setting values by successively pressing the navigation button.

The optional external power supply makes it possible to display currents < 20 % In.

Below 0.1 In, measurements are not significant. Between 0.1 and 0.2 In, accuracy changes linearly from 4 % to 1.5 %.

Communication option

In conjunction with the COM communication option, the control unit transmits the following:

- settings
- all "ammeter" measurements
- tripping causes
- maximeter readings.

Protection

Protection thresholds and delays are set using the adjustment dials.

Overload protection

True rms long-time protection.

Thermal memory: thermal image before and after tripping.

Setting accuracy may be enhanced by limiting the setting range using a different long-time rating plug.

Overload protection can be cancelled using a specific LT rating plug "Off".

Short-circuit protection

Short-time (rms) and instantaneous protection.

Selection of I^2t type (ON or OFF) for short-time delay.

Earth-fault protection

Residual or source ground return earth fault protection.

Selection of I^2t type (ON or OFF) for delay.

Residual earth-leakage protection (Vigi).

Operation without an external power supply.

⌋ Protected against nuisance tripping.

⌋ DC-component withstand class A up to 10 A.

Neutral protection

On three-pole circuit breakers, neutral protection is not possible.

On four-pole circuit breakers, neutral protection may be set using a three-position switch: neutral unprotected (4P 3d), neutral protection at 0.5 Ir (4P 3d + N/2), neutral protection at Ir (4P 4d).

Zone selective interlocking (ZSI)

A ZSI terminal block may be used to interconnect a number of control units to provide total discrimination for short-time and earth-fault protection, without a delay before tripping.

Overload alarm

A yellow alarm LED goes on when the current exceeds the long-time trip threshold.

Fault indications

LEDs indicate the type of fault:

- overload (long-time protection Ir)
- short-circuit (short-time Isd or instantaneous Ii protection)
- earth fault or earth leakage (Ig or IΔn)
- internal fault (Ap).

Battery power

The fault indication LEDs remain on until the test/reset button is pressed. Under normal operating conditions, the battery supplying the LEDs has a service life of approximately 10 years.

Test

A mini test kit or a portable test kit may be connected to the test connector on the front to check circuit-breaker operation. For 6.0 A and 7.0 A control units, the operation of earth-fault or earth-leakage protection can be checked by pressing the test button located above the test connector.

A control units protect power circuits.

They also offer measurements, display, communication and current maximeters. Version 6 provides earth-fault protection, version 7 provides earth-leakage protection.

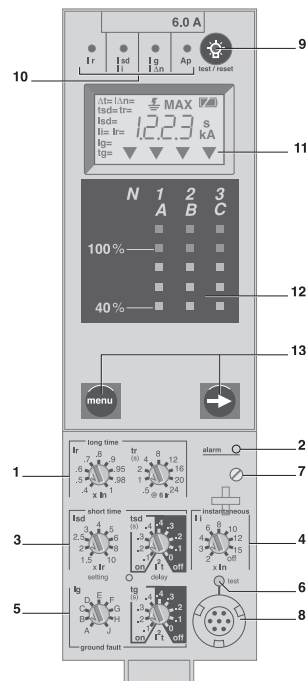

- 1 long-time threshold and tripping delay
- 2 overload alarm (LED) at 1.125 Ir
- 3 short-time pick-up and tripping delay
- 4 instantaneous pick-up
- 5 earth-leakage or earth-fault pick-up and tripping delay
- 6 earth-leakage or earth-fault test button
- 7 long-time rating plug screw
- 8 test connector
- 9 lamp test, reset and battery test
- 10 indication of tripping cause
- 11 digital display
- 12 three-phase bargraph and ammeter
- 13 navigation buttons

Note: A control units come with a transparent lead-seal cover as standard.

Molded Case Circuit Breakers BX series (800AF to 1600AF) Control units

Protection		2.0 A									
Long time											
Current setting (A)		0.4 0.5 0.6 0.7 0.8 0.9 0.95 0.98 1									
Tripping between 1.05 and 1.20 x Ir		Other ranges or disable by changing long-time rating plug									
Time setting		tr (s)									
Time delay (s)		Accuracy: 0 to -30 % 1.5 x Ir									
		Accuracy: 0 to -20 % 6 x Ir									
		Accuracy: 0 to -20 % 7.2 x Ir									
Thermal memory		20 minutes before and after tripping									
(1) 0 to -40 % - (2) 0 to -60 %											
Instantaneous											
Pick-up (A)		I _{sd} = I _r x ...									
Accuracy: ±10 %		1.5 2 2.5 3 4 5 6 8 10									
Time delay		Max resettable time: 20 ms Max break time: 80 ms									

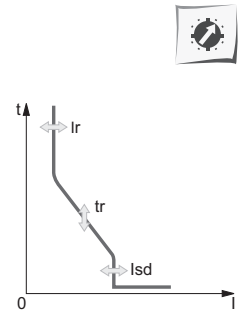

Protection		5.0 / 6.0 / 7.0 A									
Long time											
Current setting (A)		I _r = I _n x ...									
Tripping between 1.05 and 1.20 x Ir		Other ranges or disable by changing long-time rating plug									
Time setting		tr (s)									
Time delay (s)		Accuracy: 0 to -30 % 1.5 x Ir									
		Accuracy: 0 to -20 % 6 x Ir									
		Accuracy: 0 to -20 % 7.2 x Ir									
Thermal memory		20 minutes before and after tripping									
(1) 0 to -40 % - (2) 0 to -60 %											

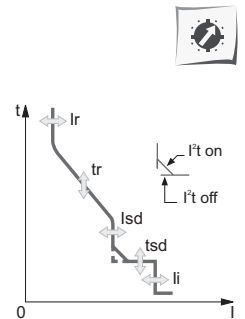

Short time											
Pick-up (A)		I _{sd} = I _r x ...									
Accuracy: ±10 %		1.5 2 2.5 3 4 5 6 8 10									
Time setting tsd (s)		Settings									
		I _{2t} Off									
		I _{2t} On									
Time delay (ms) at 10 x Ir (I _{2t} Off or I _{2t} On)		tsd (max resettable time)									
		tsd (max break time)									

Instantaneous											
Pick-up (A)		I _{li} = I _n x ...									
Accuracy: ±10 %		2 3 4 6 8 10 12 15 off									
Time delay		Max resettable time: 20 ms Max break time: 50 ms									

Earth fault											
6.0 A											
Pick-up (A)		I _g = I _n x ...									
Accuracy: ±10 %		I _n ≤ 400 A									
		400 A < I _n < 1250 A									
		I _n ≥ 1250 A									
Time setting tg (s)		Settings									
		I _{2t} Off									
		I _{2t} On									
Time delay (ms)		tg (max resettable time)									
at I _n or 1200 A (I _{2t} Off or I _{2t} On)		tg (max break time)									

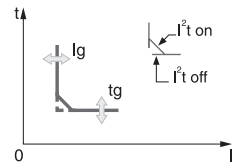

Residual earth leakage (Vigi)											
7.0 A											
Sensitivity (A)		I _{Δn}									
Accuracy: 0 to -20 %		0.5 1 2 3 5 7 10 20 30									
Time delay Δt (ms)		Settings									
		Δt (max resettable time)									
		Δt (max break time)									

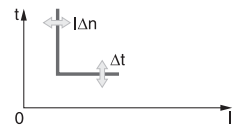

Ammeter		2.0 / 5.0 / 6.0 / 7.0 A									
Type of measurements		Range					Accuracy				
Instantaneous currents		I ₁ , I ₂ , I ₃ , I _N					± 1.5 %				
		I _g (6.0 A)					± 10 %				
		I _{Δn} (7.0 A)					± 1.5 %				
Current maximizers of		I ₁ , I ₂ , I ₃ , I _N					± 1.5 %				

Note: all current-based protection functions require no auxiliary source.
The test / reset button resets maximizers, clears the tripping indication and tests the battery.



Molded Case Circuit Breakers

BX series (800AF to 1600AF)

Control units

■ E “energy”

“Energy meter” measurements

In addition to the ammeter measurements of A

E control units measure and display:

- current demand
- voltages: phase to phase, phase to neutral, average ⁽¹⁾ and unbalanced ⁽¹⁾
- instantaneous power: P, Q, S
- power factor: PF
- power demand: P demand
- energy: Ep, Eq ⁽¹⁾, Es ⁽¹⁾.

Accuracy of active energy Ep is 2 % (including the sensors).
The range of measurement is the same as current with A, depending of an external power supply module (24 V DC).

Communication option

In conjunction with the COM communication option, the control unit transmits the following:

- settings
- all “ammeter” and “energy” measurements
- enable connection to FDM121
- tripping causes
- maximeter / minimeter readings.

Protection

Protection thresholds and delays are set using the adjustment dials.

Overload protection

True rms long-time protection.

Thermal memory: thermal image before and after tripping.

Setting accuracy may be enhanced by limiting the setting range using a different long-time rating plug. Overload protection can be cancelled using a specific LT rating plug “Off”.

Short-circuit protection

Short-time (rms) and instantaneous protection.

Selection of I²t type (ON or OFF) for short-time delay.

Earth-fault protection

Source ground return earth fault protection.

Selection of I²t type (ON or OFF) for delay.

Neutral protection

On three-pole circuit breakers, neutral protection is not possible.

On four-pole circuit breakers, neutral protection may be set using a three-position switch: neutral unprotected (4P 3d), neutral protection at 0.5 Ir (4P 3d + N/2), neutral protection at Ir (4P 4d).

Zone selective interlocking (ZSI)

A ZSI terminal block may be used to interconnect a number of control units to provide total discrimination for short-time and earth-fault protection, without a delay before tripping.

Overload alarm

A yellow alarm LED goes on when the current exceeds the long-time trip threshold.

Programmable contacts

The programmable contacts may be used to signal events (Ir, Isd, Alarm Ir, Alarm Ig, Ig). They can be programmed using the keypad on the E control unit or remotely using the COM option (BCM ULP) and RSU software.

Fault indications

LEDs indicate the type of fault:

- overload (long-time protection Ir)
- short-circuit (short-time Isd or instantaneous Ii protection)
- earth fault (Ig)
- internal fault (Ap).

Trip history

The trip history displays the list of the last 10 trips. For each trip, the following indications are recorded and displayed:

- the tripping cause: Ir, Isd, Ii, Ig or Auto-protection (Ap) trips
- the date and time of the trip (requires communication option).

Battery power

The fault indication LEDs remain on until the test/reset button is pressed. Under normal operating conditions, the battery supplying the LEDs has a service life of approximately 10 years.

Test

A mini test kit or a portable test kit may be connected to the test connector on the front to check circuit-breaker operation. For 6.0 E control units, the operation of earth-fault or earth-leakage protection can be checked by pressing the test button located above the test connector.

E control units protect power circuits. They also offer measurements, display, communication and current maximeters. Version 6 provides earth-fault protection.

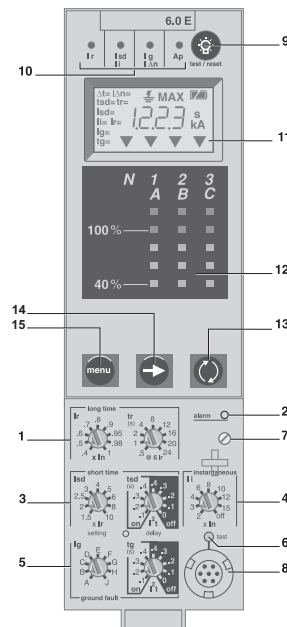

- 1 long-time threshold and tripping delay
- 2 overload alarm (LED) at 1.125 Ir
- 3 short-time pick-up and tripping delay
- 4 instantaneous pick-up
- 5 earth-leakage or earth-fault pick-up and tripping delay
- 6 earth-leakage or earth-fault test button
- 7 long-time rating plug screw
- 8 test connector
- 9 lamp test, reset and battery test
- 10 indication of tripping cause
- 11 digital display
- 12 three-phase bargraph and ammeter
- 13 navigation button “quick View” (only with E)
- 14 navigation button to view menu contents
- 15 navigation button to change menu

(1) Display on FDM121 only.

Note: E control units come with a transparent lead-seal cover as standard.

Molded Case Circuit Breakers BX series (800AF to 1600AF) Control units

Protection		2.0 E									
Long time											
Current setting (A)		0.4 0.5 0.6 0.7 0.8 0.9 0.95 0.98 1									
Tripping between 1.05 and 1.20 x Ir		Other ranges or disable by changing long-time rating plug									
Time setting		tr (s) 0.5 1 2 4 8 12 16 20 24									
Time delay (s)	Accuracy: 0 to -30 %	1.5 x Ir	12.5	25	50	100	200	300	400	500	600
	Accuracy: 0 to -20 %	6 x Ir	0.7 ⁽¹⁾	1	2	4	8	12	16	20	24
	Accuracy: 0 to -20 %	7.2 x Ir	0.7 ⁽²⁾	0.69	1.38	2.7	5.5	8.3	11	13.8	16.6
Thermal memory		20 minutes before and after tripping									
(1) 0 to -40 % - (2) 0 to -60 %											
Instantaneous											
Pick-up (A)	Isd = Ir x ...	1.5	2	2.5	3	4	5	6	8	10	
Accuracy: ±10 %											
Time delay		Max resettable time: 20 ms Max break time: 80 ms									

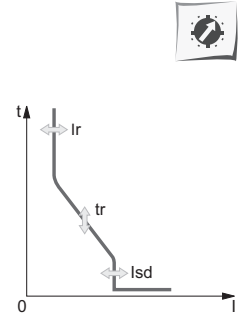

Protection		5.0 / 6.0 E									
Long time											
Current setting (A)		Ir = In x ...									
Tripping between 1.05 and 1.20 x Ir		Other ranges or disable by changing long-time rating plug									
Time setting		tr (s) 0.5 1 2 4 8 12 16 20 24									
Time delay (s)	Accuracy: 0 to -30 %	1.5 x Ir	12.5	25	50	100	200	300	400	500	600
	Accuracy: 0 to -20 %	6 x Ir	0.7 ⁽¹⁾	1	2	4	8	12	16	20	24
	Accuracy: 0 to -20 %	7.2 x Ir	0.7 ⁽²⁾	0.69	1.38	2.7	5.5	8.3	11	13.8	16.6
Thermal memory		20 minutes before and after tripping									
(1) 0 to -40 % - (2) 0 to -60 %											
Short time											
Pick-up (A)	Isd = Ir x ...	1.5	2	2.5	3	4	5	6	8	10	
Accuracy: ±10 %											
Time setting tsd (s)	Settings	I ² t Off	0	0.1	0.2	0.3	0.4				
		I ² t On	-	0.1	0.2	0.3	0.4				
Time delay (ms) at 10 x Ir (I ² t Off or I ² t On)	tsd (max resettable time)	20	80	140	230	350					
	tsd (max break time)	80	140	200	320	500					
Instantaneous											
Pick-up (A)	Ii = In x ...	2	3	4	6	8	10	12	15	off	
Accuracy: ±10 %											
Time delay		Max resettable time: 20 ms Max break time: 50 ms									

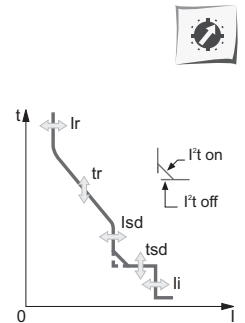

Earth fault		6.0 E									
Pick-up (A)	Ig = In x ...	A	B	C	D	E	F	G	H	J	
Accuracy: ±10 %	In ≤ 400 A	0.3	0.3	0.4	0.5	0.6	0.7	0.8	0.9	1	
	400 A < In < 1250 A	0.2	0.3	0.4	0.5	0.6	0.7	0.8	0.9	1	
	In ≥ 1250 A	500	640	720	800	880	960	1040	1120	1200	
Time setting tg (s)	Settings	I ² t Off	0	0.1	0.2	0.3	0.4				
		I ² t On	-	0.1	0.2	0.3	0.4				
Time delay (ms) at In or 1200 A (I ² t Off or I ² t On)	tg (max resettable time)	20	80	140	230	350					
	tg (max break time)	80	140	200	320	500					
Energy		2.0 / 5.0 / 6.0 E									
Type of measurements		Range Accuracy									
Instantaneous currents	I ₁ , I ₂ , I ₃ , I _N	0.2 x In to 1.2 x In									± 1.5 %
	I _g (6.0 E)	0.05 x In to In									± 10 %
Current maximeters of	I ₁ , I ₂ , I ₃ , I _N	0.2 x In to 1.2 x In									± 1.5 %
Demand currents of I ₁ , I ₂ , I ₃ , I _g		0.2 x In to 1.2 x In									± 1.5 %
Voltages	V12, V23, V31, V1N, V2N, V3N	100 to 690 V									± 0.5 %
Active power	P	30 to 2000 kW									± 2 %
Power factor	PF	0 to 1									± 2 %
Demand power	P demand	30 to 2000 kW									± 2 %
Active energy	Ep	-1010 GWh to 1010 GWh									± 2 %

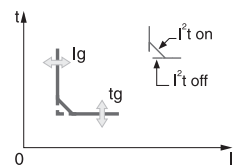

Note: all current-based protection functions require no auxiliary source.
The test / reset button resets maximeters, clears the tripping indication and tests the battery.



Molded Case Circuit Breakers BX series (800AF to 1600AF) Control units

■ P "power"

Protection



Protection settings

The adjustable protection functions are identical to those of A (overloads, short-circuits, earth-fault and earth-leakage protection).

Fine adjustment

Within the range determined by the adjustment dial, fine adjustment of thresholds (to within one ampere) and time delays (to within one second) is possible on the keypad or remotely using the COM option.

IDMTL (Inverse Definite Minimum Time Lag) setting

Coordination with fuse-type or medium-voltage protection systems is optimised by adjusting the slope of the overload-protection curve. This setting also ensures better operation of this protection function with certain loads.

Neutral protection

On three-pole circuit breakers, neutral protection may be set using the keypad or remotely using the COM option, to one of four positions: neutral unprotected (4P 3d), neutral protection at 0.5 I_r (4P 3d + N/2), neutral protection at I_r (4P 4d) and neutral protection at 1.6 I_r (4P 3d + 1.6N). Neutral protection at 1.6 I_r is used when the neutral conductor is twice the size of the phase conductors (major load imbalance, high level of third order harmonics).

On four-pole circuit breakers, neutral protection may be set using a three-position switch or the keypad: neutral unprotected (4P 3d), neutral protection at 0.5 I_r (4P 3d + N/2), neutral protection at I_r (4P 4d). Neutral protection produces no effect if the long-time curve is set to one of the IDMTL protection settings.

Programmable alarms and other protection

Depending on the thresholds and time delays set using the keypad or remotely using the COM option, the P control unit monitors currents and voltage, power, frequency and the phase sequence. Each threshold overrun is signalled remotely via the COM option. Each threshold overrun may be combined with tripping (protection) or an indication carried out by an optional M6C programmable contact (alarm), or both (protection and alarm).

Load shedding and reconnection

Load shedding and reconnection parameters may be set according to the power or the current flowing through the circuit breaker. Load shedding is carried out by a supervisor via the COM option or by an M6C programmable contact.

Indication option via programmable contacts

The M6C (six contacts) auxiliary contacts may be used to signal threshold overruns or status changes. They can be programmed using the keypad on the P control unit or remotely using the COM option (BCM ULP) and RSU software.

Communication option (COM)

The communication option may be used to:

- remotely read and set parameters for the protection functions
- transmit all the calculated indicators and measurements
- signal the causes of tripping and alarms
- consult the history files and the maintenance-indicator register
- maximeter reset.

An event log and a maintenance register, stored in control-unit memory but not available locally, may be accessed in addition via the COM option.

P control units include all the functions offered by A.

In addition, they measure voltages and calculate power and energy values.

They also offer new protection functions based on currents, voltages, frequency and power reinforce load protection in real time.

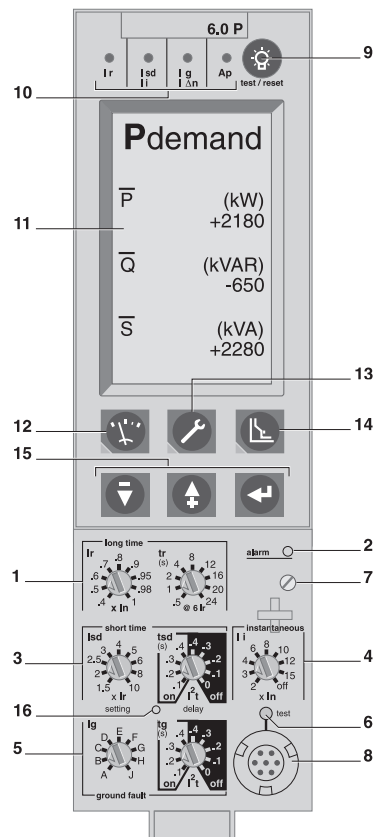

- 1 Long-time current setting and tripping delay.
- 2 Overload signal (LED).
- 3 Short-time pick-up and tripping delay.
- 4 Instantaneous pick-up.
- 5 Earth-leakage or earth-fault pick-up and tripping delay.
- 6 Earth-leakage or earth-fault test button.
- 7 Long-time rating plug screw.
- 8 Test connector.
- 9 Lamp + battery test and indications reset.
- 10 Indication of tripping cause.
- 11 High-resolution screen.
- 12 Measurement display.
- 13 Maintenance indicators.
- 14 Protection settings.
- 15 Navigation buttons.
- 16 Hole for settings lockout pin on cover.

Note: P control units come with a non-transparent lead-seal cover as standard.

Molded Case Circuit Breakers BX series (800AF to 1600AF) Control units

Protection		5.0 / 6.0 / 7.0 P									
Long time (rms)											
Current setting (A)	$I_r = I_n \times \dots$	0.4	0.5	0.6	0.7	0.8	0.9	0.95	0.98	1	
Tripping between 1.05 and 1.20 x I_r		Other ranges or disable by changing long-time rating plug									
Time setting	t_r (s)	0.5	1	2	4	8	12	16	20	24	
Time delay (s)	Accuracy: 0 to -30 %	$1.5 \times I_r$	12.5	25	50	100	200	300	400	500	600
	Accuracy: 0 to -20 %	$6 \times I_r$	0.7 ⁽¹⁾	1	2	4	8	12	16	20	24
	Accuracy: 0 to -20 %	$7.2 \times I_r$	0.7 ⁽²⁾	0.69	1.38	2.7	5.5	8.3	11	13.8	16.6
IDMTL setting	Curve slope		SIT	VIT	EIT	HVFuse	DT				
Thermal memory		20 minutes before and after tripping									
(1) 0 to -40 % - (2) 0 to -60 %											
Short time (rms)											
Pick-up (A)	$I_{sd} = I_r \times \dots$	1.5	2	2.5	3	4	5	6	8	10	
Accuracy: $\pm 10\%$											
Time setting t_{sd} (s)	Settings	I^2t Off	0	0.1	0.2	0.3	0.4				
		I^2t On	-	0.1	0.2	0.3	0.4				
Time delay (ms) at 10 I_r (I^2t Off or I^2t On)	t_{sd} (max resettable time)		20	80	140	230	350				
	t_{sd} (max break time)		80	140	200	320	500				
Instantaneous											
Pick-up (A)	$I_i = I_n \times \dots$	2	3	4	6	8	10	12	15	off	
Accuracy: $\pm 10\%$											
Time delay		Max resettable time: 20 ms Max break time: 50 ms									
Earth fault		6.0 P									
Pick-up (A) Accuracy: $\pm 10\%$	$I_g = I_n \times \dots$	A	B	C	D	E	F	G	H	J	
	$I_n \leq 400$ A	0.3	0.3	0.4	0.5	0.6	0.7	0.8	0.9	1	
	400 A < $I_n < 1250$ A	0.2	0.3	0.4	0.5	0.6	0.7	0.8	0.9	1	
	$I_n \geq 1250$ A	500	640	720	800	880	960	1040	1120	1200	
Time setting t_g (s)	Settings	I^2t Off	0	0.1	0.2	0.3	0.4				
		I^2t On	-	0.1	0.2	0.3	0.4				
Time delay (ms)	t_g (max resettable time)		20	80	140	230	350				
	at I_n or 1200 A (I^2t Off or I^2t On)	t_g (max break time)		80	140	200	320	500			
Residual earth leakage (Vigi)		7.0 P									
Sensitivity (A)	$I_{\Delta n}$	0.5	1	2	3	5	7	10	20	30	
Accuracy: 0 to -20 %											
Time delay Δt (ms)	Settings		60	140	230	350	800				
	Δt (max resettable time)		60	140	230	350	800				
	Δt (max break time)		140	200	320	500	1000				
Alarms and other protection		5.0 / 6.0 / 7.0 P									
Current		Threshold					Delay				
Current unbalance	$I_{unbalance}$	0.05 to 0.6 Iaverage					1 to 40 s				
Max. demand current	$I_{max\ demand}$: I1, I2, I3, IN,	0.2 I_n to I_n					15 to 1500 s				
Earth fault alarm		I_t					10 to 100 % I_n ⁽³⁾				
							1 to 10 s				
Voltage											
Voltage unbalance	$U_{unbalance}$	2 to 30 % x $U_{average}$					1 to 40 s				
Minimum voltage	U_{min}	100 to U_{max} between phases					1.2 to 10 s				
Maximum voltage ⁽⁴⁾	U_{max}	U_{min} to 1200 between phases					1.2 to 10 s				
Power											
Reverse power	rP	5 to 500 kW					0.2 to 20 s				
Frequency											
Minimum frequency	F_{min}	45 to F_{max}					1.2 to 5 s				
Maximum frequency	F_{max}	F_{min} to 440 Hz					1.2 to 5 s				
Phase sequence											
Sequence (alarm)	$\Delta\emptyset$	$\emptyset 1/2/3$ or $\emptyset 1/3/2$					0.3 s				
Load shedding and reconnection		5.0 / 6.0 / 7.0 P									
Measured value		Threshold					Delay				
Current	I	0.5 to 1 I_r per phases					20 % t_r to 80 % t_r				
Power	P	200 kW to 10 MW					10 to 3600 s				
Power		5.0 / 6.0 / 7.0 P									
Type of measurements		Range					Accuracy				
Current maximeters of	I_1, I_2, I_3, I_N	0.2 x I_n to 1.2 x I_n					$\pm 1.5\%$				
Voltages	V12, V23, V31, V1N, V2N, V3N	100 to 690 V					$\pm 0.5\%$				
Power factor	PF	0 to 1					$\pm 2\%$				
Frequency (Hz)							0.1 %				

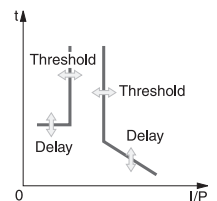
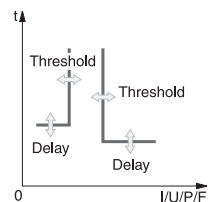
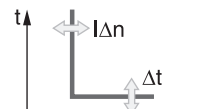
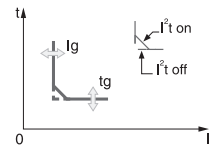
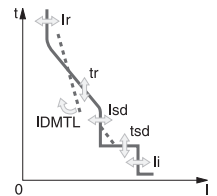

(3) $I_n \leq 400$ A 30 %, 400 A < $I_n < 1250$ A 20 %, $I_n \geq 1250$ A 10 %

(4) For 690 V applications, a step-down transformer must be used if the voltage exceeds the nominal value of 690 V by more than 10 %.

Note: all current-based protection functions require no auxiliary source.

Voltage-based protection functions are connected to AC power via a voltage measurement input built into the circuit breaker.

Molded Case Circuit Breakers BX series (800AF to 1600AF) Control units

■ P "power"



Measurements

The P control unit calculates in real time all the electrical values (V, A, W, VAR, VA, Wh, VARh, VAh, Hz), power factors and cosj factors.

The P control unit also calculates demand current and demand power over an adjustable time period. Each measurement is associated with a minimeter and a maximeter.

In the event of tripping on a fault, the interrupted current is stored. The optional external power supply makes it possible to display the value with the circuit breaker open or not supplied.

Instantaneous values

The value displayed on the screen is refreshed every second. Minimum and maximum values of measurements are stored in memory (minimeters and maximeters).

Currents					
I rms	A	1	2	3	N
	A	E-fault		E-leakage	
I max rms	A	1	2	3	N
	A	E-fault		E-leakage	
Voltages					
U rms	V	12	23	31	
V rms	V	1N	2N	3N	
U average rms	V	(U12 + U23 + U31) / 3			
U unbalance	%				
Power, energy					
P active, Q reactive, S apparent	W, Var, VA	Totals			
E active, E reactive, E apparent	Wh, VARh, VAh	Totals consumed - supplied			
		Totals consumed			
		Totals supplied			
Power factor	PF	Total			
Frequencies					
F	Hz				

Demand metering

The demand is calculated over a fixed or sliding time window that may be programmed from 5 to 60 minutes. According to the contract signed with the power supplier, an indicator associated with a load shedding function makes it possible to avoid or minimise the costs of overrunning the subscribed power. Maximum demand values are systematically stored and time stamped (maximeter).

Currents					
I demand	A	1	2	3	N
	A	E-fault		E-leakage	
I max demand	A	1	2	3	N
	A	E-fault		E-leakage	
Power					
P, Q, S demand	W, Var, VA	Totals			
P, Q, S max demand	W, Var, VA	Totals			

Minimeters and maximeters

Only the current and power maximeters may be displayed on the screen.

Time-stamping

Time-stamping is activated as soon as time is set manually or by a supervisor.

No external power supply module is required (max. drift of 1 hour per year).

Reset

An individual reset, via the keypad or remotely, acts on alarms, minimum and maximum data, peak values, the counters and the indicators.

Additional measurements accessible with the COM option

Some measured or calculated values are only accessible with the COM communication option:

- $I_{peak} / \sqrt{2}, (I_1 + I_2 + I_3)/3, I_{unbalance}$
- load level in % Ir
- total power factor.

The maximeters and minimeters are available only via the COM option for use with a supervisor.

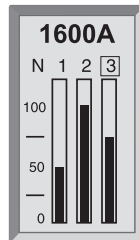

Default display.

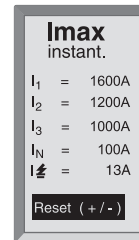

Display of a maximum current.

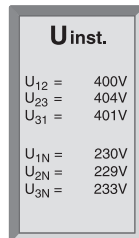

Display of a voltage.

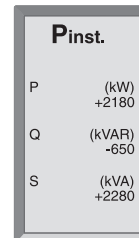

Display of a power.

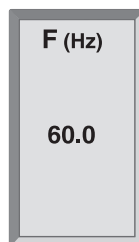

Display of a frequency.

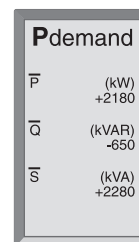

Display of a demand power.

Histories and maintenance indicators.....



The last ten trips and alarms are recorded in two separate history files that may be displayed on the screen:

- tripping history:
 - type of fault
 - date and time
 - values measured at the time of tripping (interrupted current, etc.)
- alarm history:
 - type of alarm
 - date and time
 - values measured at the time of the alarm.

All the other events are recorded in a third history file which is only accessible through the communication network.

- Event log history (only accessible through the communication network):
 - modifications to settings and parameters
 - counter resets
 - system faults
 - fallback position
 - thermal self-protection
 - loss of time
 - overrun of wear indicators
 - test-kit connections
 - etc.

Note: All the events are time stamped: time-stamping is activated as soon as time is set manually or by a supervisor. No external power supply module is required (max. drift of 1 hour per year).

Maintenance indicators with COM option (BCM ULP)

A number of maintenance indicators may be called up on the screen to better plan for device maintenance:

- contact wear
- operation counter:
 - cumulative total
 - total since last reset.

Additional maintenance indicators are also available through the COM network, and can be used as an aid in troubleshooting:

- highest current measured
- number of test-kit connections
- number of trips in operating mode and in test mode.

Additional technical characteristics

Safety

Measurement functions are independent of the protection functions.

The high-accuracy measurement module operates independently of the protection module.

Simplicity and multi-language

Navigation from one display to another is intuitive. The six buttons on the keypad provide access to the menus and easy selection of values. When the setting cover is closed, the keypad may no longer be used to access the protection settings, but still provides access to the displays for measurements, histories, indicators, etc.

Control unit is also multi-language, including the following languages: English, Spanish, Portuguese, Russian, Chinese, French, German...

Intelligent measurement

Measurement-calculation mode:

- energies are calculated on the basis of the instantaneous power values, in two manners:
 - the traditional mode where only positive (consumed) energies are considered
 - the signed mode where the positive (consumed) and negative (supplied) energies are considered separately
- measurement functions implement the new “zero blind time” concept which consists in continuously measuring signals at a high sampling rate. The traditional “blind window” used to process samples no longer exists. This method ensures accurate energy calculations even for highly variable loads (welding machines, robots, etc.).

Always powered

All current-based protection functions require no auxiliary source. Voltage-based protection functions are connected to AC power via a voltage measurement input built into the circuit breaker.

Stored information

The fine setting adjustments, the last 100 events and the maintenance register remain in the control-unit memory even when power is lost.

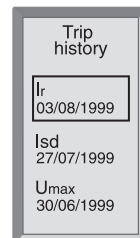

Display of a tripping history.

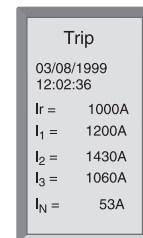

Display after tripping.

Molded Case Circuit Breakers

BX series (800AF to 1600AF)

Power Meter functions

■ A/E/P control unit with COM option (BCM ULP)

A/E/P measurement functions are made possible by Control unit intelligence and the accuracy of the sensors. They are handled by a microprocessor that operates independent of protection functions.

In addition to protection functions, A/E/P control units offer all the functions of Power Meter products as well as operating-assistance for the circuit breaker.

Measurements



Instantaneous rms measurements

The control unit continuously display the RMS value of the highest current of the three phases and neutral (I_{max}). The navigation buttons can be used to scroll through the main measurements.

In the event of a fault trip, the trip cause is displayed.

The control unit A measures phase, neutral, ground fault currents.

The control unit E offers voltage, power, Power Factor, measurements in addition to the measurements provided by control unit A.

The control unit P offer frequency, $\cos \phi$ in addition to the measurements provided by control unit E.

Maximeters / minimeters

Every instantaneous measurement provided by control unit A or E can be associated with a maximeter/minimeter. The maximeters for the highest current of the 3 phases and neutral, the demand current and power can be reset via the FDM121 display unit or the communication system.

Energy metering

The control unit E/P also measures the energy consumed since the last reset of the meter. The active energy meter can be reset via control unit keypad or the FDM121 display unit or the communication system.

Demand and maximum demand values

control unit E/P also calculates demand current and power values. These calculations can be made using a block or sliding interval that can be set from 5 to 60 minutes in steps of 1 minute. The window can be synchronised with a signal sent via the communication system. Whatever the calculation method, the calculated values can be recovered on a PC via Modbus communication.

Ordinary spreadsheet software can be used to provide trend curves and forecasts based on this data. They will provide a basis for load shedding and reconnection operations used to adjust consumption to the subscribed power.

Molded Case Circuit Breakers BX series (800AF to 1600AF) Power Meter functions



Control units A/E/P integrated Power Meter functions			Type		Display
			A/E	P	Control unit LCD
Display of protection settings					
Pick-ups (A) and delays	All settings can be displayed	I _r , t _r , I _{sd} , t _{sd} , I _i , I _g , t _g	A/E	P	■
Measurements					
Instantaneous rms measurements					
Currents (A)	Phases and neutral	I ₁ , I ₂ , I ₃ , I _N	A/E	P	■
	Average of phases	$I_{avg} = (I_1 + I_2 + I_3) / 3$	A/E	P	-
	Highest current of the 3 phases and neutral	I _{max} of I ₁ , I ₂ , I ₃ , I _N	A/E	P	■
	Ground fault (control unit 6)	% I _g (pick-up setting)	A/E	P	■
	Current unbalance between phases	% I _{avg}	- / E	P	-
Voltages (V)	Phase-to-phase	V ₁₂ , V ₂₃ , V ₃₁	- / E	P	■
	Phase-to-neutral	V _{1N} , V _{2N} , V _{3N}	- / E	P	■
	Average of phase-to-phase voltages	$V_{avg} = (V_{12} + V_{23} + V_{31}) / 3$	- / E	P	-
	Average of phase-to-neutral voltages	$V_{avg} = (V_{1N} + V_{2N} + V_{3N}) / 3$	- / E	P	-
	Ph-Ph and Ph-N voltage unbalance	% V _{avg} and % V _{avg}	- / E	P	-
	Phase sequence	1-2-3, 1-3-2	- / -	P	■
Frequency (Hz)	Power system	f	- / -	P	■
Power	Active (kW)	P, total	- / E	P	■
		P, per phase	- / E	P	■ ⁽²⁾
	Reactive (kVAR)	Q, total	- / E	P	■
		Q, per phase	- / -	P	■ ⁽²⁾
	Apparent (kVA)	S, total	- / E	P	■
		S, per phase	- / -	P	■ ⁽²⁾
	Power Factor	PF, total	- / E	P	■
		PF, per phase	- / -	P	■ ⁽²⁾
Cos.ϕ	Cos.ϕ, total	- / -	P	■ ⁽²⁾	
	Cos.ϕ, per phase	- / -	P	■ ⁽²⁾	
Maximeters / minimeters					
	Associated with instantaneous rms measurements	Reset via FDM121 display unit and control unit keypad	A/E	P	■
Energy metering					
Energy	Active (kW), reactive (kVARh), apparent (kVAh)	Total since last reset	- / E	P	■
Demand and maximum demand values					
Demand current (A)	Phases and neutral	Present value on the selected window	- / E	P	■
		Maximum demand since last reset	- / E	P	■ ⁽²⁾
Demand power	Active (kWh), reactive (kVAR), apparent (kVA)	Present value on the selected window	- / E	P	■
		Maximum demand since last reset	- / E	P	■ ⁽²⁾
Calculation window	Sliding, fixed or com-synchronised	Adjustable from 5 to 60 minutes in 1 minute steps ⁽¹⁾	- / E	P	-

(1) Available via the communication system only.

(2) Available for control unit P only.

Molded Case Circuit Breakers

BX series (800AF to 1600AF)

Operating-assistance functions

■ A/E/P control unit with COM option (BCM ULP)

Histories



- Trip indications in clear text in a number of user-selectable languages.
- Time-stamping: date and time of trip.

Maintenance indicators.....



Control unit have indicators for, among others, the number of operating cycles, contact wear P, load profile and operating times (operating hours counter) of the DW air circuit breaker. It is possible to assign an alarm to the operating cycle counter to plan maintenance.

The various indicators can be used together with the trip histories to analyse the level of stresses the device has been subjected to.

Management of installed devices

Each circuit breaker equipped with a COM option (BCM ULP) can be identified via the communication system:

- serial number
- firmware version
- hardware version
- device name assigned by the user.

This information together with the previously described indications provides a clear view of the installed devices.

A/E/P operating assistance functions			Type		Display
			A/E	P	Control unit LCD
Operating assistance					
Trip history					
Trips	Cause of tripping	Ir, lsd, li, lg, lΔn	- /E	P	■
Maintenance indicators					
Counter	Mechanical cycles	Assignable to an alarm	A/E	P	-
	Electrical cycles	Assignable to an alarm	A/E	P	-
	Hours	Total operating time (hours) ⁽¹⁾	A/E	P	-
Indicator	Contact wear	%	- / -	P	-
Load profile	Hours at different load levels	% of hours in four current ranges: 0-49 % In, 50-79 % In, 80-89 % In and ≥ 90 % In	A /E	P	-

(1) Also available via the communication system.

Additional technical characteristics

Contact wear

Each time Compact opens, the P trip unit measures the interrupted current and increments the contact-wear indicator as a function of the interrupted current, according to test results stored in memory. Breaking under normal load conditions results in a very slight increment. The indicator value may be read on the FDM121 display. It provides an estimation of contact wear calculated on the basis of the cumulative forces affecting the circuit breaker. When the indicator reaches 100 %, it is advised to inspect the circuit breaker to ensure the availability of the protected equipment.

Circuit breaker load profile

Control units A/E/P calculates the load profile of the circuit breaker protecting a load circuit. The profile indicates the percentage of the total operating time at four current levels (% of breaker In):

- 0 to 49 % In
- 50 to 79 % In
- 80 to 89 % In
- ≥ 90 % In.

This information can be used to optimise use of the protected equipment or to plan ahead for extensions.

Molded Case Circuit Breakers BX series (800AF to 1600AF) Switchboard-display functions

Communication components

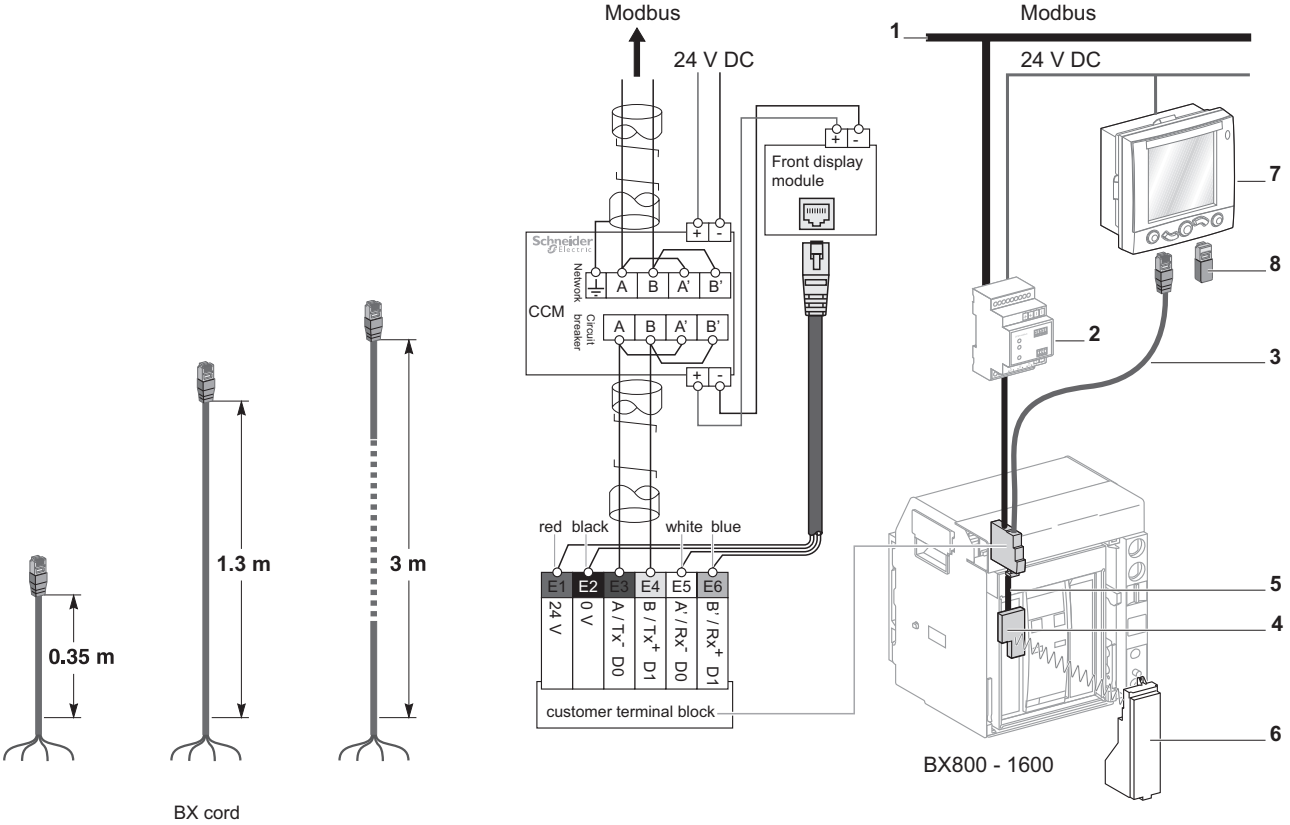

Molded Case Circuit Breakers

BX series (800AF to 1600AF)

Protection of distribution systems

■ Control units for BX800 to 1600

• External sensors

External sensor for earth-fault and neutral protection

The sensors, used with the 3P circuit breakers, are installed on the neutral conductor for:

- neutral protection (with P)
- residual type earth-fault protection (with A, E and P).

The rating of the sensor (CT) must be compatible with the rating of the circuit breaker:

- BX800 to 1600 A - 400/1600 CT

Rectangular sensor for earth-leakage protection

The sensor is installed around the busbars (phases + neutral) to detect the zero-phase sequence current required for the earth-leakage protection. Rectangular sensors are available in two sizes.

Inside dimensions (mm)

- 280 x 115 up to 1600 A for BX800 to 1600 A

• Long-time rating plug

Four interchangeable plugs may be used to limit the long-time threshold setting range for higher accuracy.

The time delay settings indicated on the plugs are for an overload of 6 I_r (for further details, see the characteristics on page 95 and page 99).

As standard, control units are equipped with the 0.4 to 1 plug.

Setting ranges

Standard	I _r = I _n x...	0.4	0.5	0.6	0.7	0.8	0.9	0.95	0.98	1
Low-setting option	I _r = I _n x...	0.4	0.45	0.50	0.55	0.60	0.65	0.70	0.75	0.8
High-setting option	I _r = I _n x...	0.80	0.82	0.85	0.88	0.90	0.92	0.95	0.98	1
Off plug	No long-time protection (I _r = I _n for I _{sd} setting)									

Important: long-time rating plugs must always be removed before carrying out insulation or dielectric withstand tests.

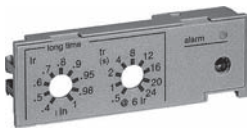

Long-time rating plug

• External 24 V DC power-supply module

The external power-supply module makes it possible to use the display even if the circuit breaker is open or not supplied (for the exact conditions of use, see the “electrical diagrams” part of this catalogue).

This module powers both the control unit (100 mA) and M6C programmable contacts (100 mA).

If the COM communication option is used, the communication bus requires 24 V DC power supply. With the A/E control unit, this module makes it possible to display currents of less than 20 % of I_n.

With the control unit P, it can be used to display fault currents after tripping.

Characteristics

■ Power supply:

- 110/130, 200/240, 380/415 V AC (+10 % -15 %)

- 24/30, 48/60, 100/125 V DC (+20 % -20 %).

- Output voltage: 24 V DC ±5 %, 1 A.

- Ripple < 1 %.

- Dielectric withstand : 3.5 kV rms between input/output, for 1 minute.

- Overvoltage category: as per IEC 60947-1 cat. 4.

Protection setting functions

GetnSet can also be used to back up circuit breaker settings and restore them on the same device or, under certain conditions, copy them to any BX circuit breakers equipped with the same type of Control unit.

This concerns only advanced settings, as other parameters must be set manually using the dials on the control unit.

- When commissioning the installation, safeguard the configuration parameters of your electrical distribution system by creating a back-up of circuit breaker settings so that they can be restored at any time.
- The settings read by GetnSet can be transferred to a PC and are compatible with RSU software (Remote Setting Utility). Protection configurations can also be created on a PC using this software, copied to GetnSet's internal memory and uploaded to a BX and DW circuit breakers with a compatible trip unit and dial settings.

Operating procedure

The procedure includes several steps.

- Plug GetnSet into the receptacle on the front of the control unit of a BX and DW circuit breakers.
- On the keypad, select the type of data (operating data or settings) and the transfer direction (download or upload). This operation can be done as many times as required for the entire set of BX and DW circuit breakers.
- Downloaded data is transferred to the GetnSet internal memory and a file is created for each BX device (either an .rsu file for settings or a.dgl file for operating data).
- Data can be transferred between GetnSet and a PC via a USB or Bluetooth connection.
- Operating data can be imported in an Excel spreadsheet and protection settings can be read with RSU (remote setting utility) software.

Features

- Battery-powered to power a control unit even if the breaker has been opened or tripped. This battery provides power for an average of 1 hour of use, enough for more than 100 download operations.
- Can be used on BX and DW circuit breakers equipped or not equipped with a Modbus "device" communication module.
- Portable, standalone accessory eliminating the need for a PC to connect to a Compact and Masterpact circuit breakers.
- No driver or software required for GetnSet connection to a PC.
- Can be used with many circuit breakers, one after the other.
- Embedded memory sized to hold data from more than 5000 circuit breakers.
- Supplied with its battery, a cable for connection to trip units, a USB cable for connection to a PC and a battery charger.

Compatibility

- Control units A, E, P.
- PC with USB port or Bluetooth link and Excel software.

Technical characteristics

Charger power supply	100 - 240 V; ~1 A; 50 - 60 Hz
Charger power consumption	Max 100 W
Battery	3.3 V DC; 9 mAh; Li-Ion
Operating temperature	-20 to +60 °C
GetnSet dimensions	95 x 60 x 35 mm

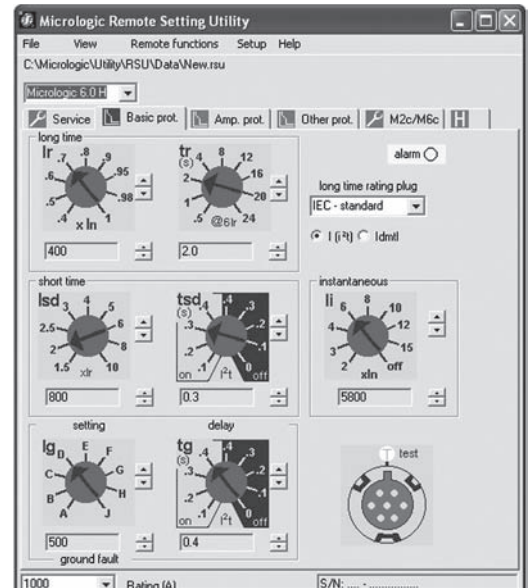

Molded Case Circuit Breakers BX series (800AF to 1600AF) Communication

■ BX800 to 1600 COM option

For fixed devices, the COM option is made up of:

- a Modbus BCM ULP “device” communication module, installed behind the Control unit and supplied with its set of sensors (OF, SDE, PF and CH micro switches) its kit for connection to XF and MX1 communicating voltage releases and its COM terminal block (inputs E1 to E6).

For drawout devices, the COM option is made up of:

- a Modbus BCM ULP “device” communication module, installed behind the Control unit and supplied with its set of sensors (OF, SDE, PF and CH micro switches) its kit for connection to XF and MX1 communicating voltage releases and its COM terminal block (inputs E1 to E6).
- a “chassis” communication module supplied separately with its set of sensors (CE, CD and CT contacts) Modbus CCM.

Modbus BCM ULP “Device” communication module

This module is independent of the control unit. It receives and transmits information on the communication network. An infra-red link transmits data between the control unit and the communication module.

Consumption: 30 mA, 24 V.

XF and MX1 communicating voltage releases

The XF and MX1 communicating voltage releases are equipped for connection to the “device” communication module.

The remote-tripping function (MX2 or MN) are independent of the communication option. They are not equipped for connection to the “device” communication module.

All the BX devices can be fitted with the communication function thanks to the COM option.

BX uses the Modbus communications protocol for full compatibility with the supervision management systems. An external gateway is available for communication on other networks:

Eco COM is limited to the transmission of metering data and status. It is not used to communicate controls.



Modbus BCM ULP “device” communication module.

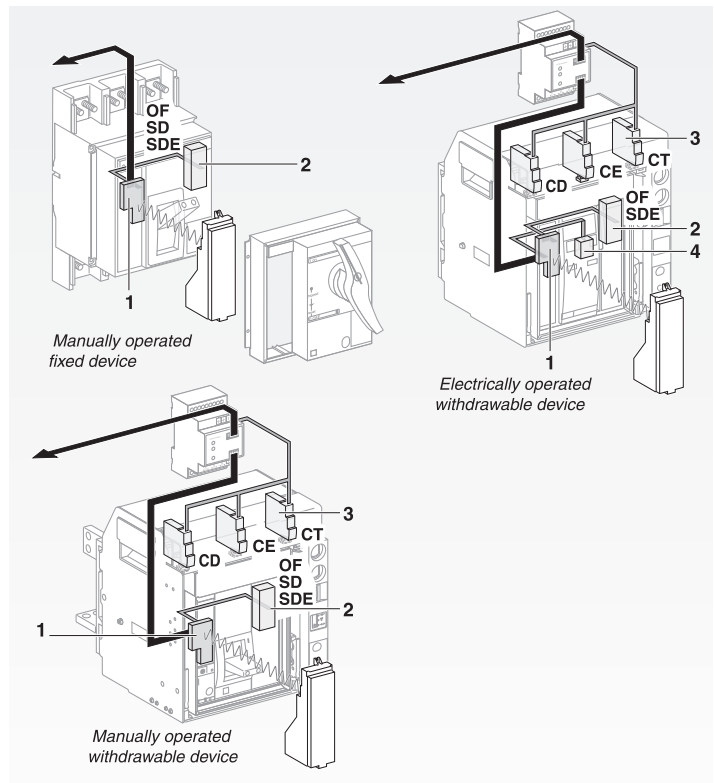

- 1 Modbus BCM ULP “Device” communication module.
- 2 OF, SDE, PF and CH micro switches.
- 3 CE, CD and CT contacts.
- 4 XF, MN or MX communicating voltage releases.

— : Hard wire.
— : Modbus.

■ Overview of functions

Four functional levels

The BX can be integrated into a Modbus communication environment.

There are four possible functional levels that can be combined.

	Switch-disconnectors	Circuit breaker
Status indications		
ON/OFF (O/F)	○	S A E P
Spring charged CH	○	S A E P
Ready to close	○	S A E P
Fault-trip SDE	○	S A E P
Connected / disconnected / test position	○	S A E P
CE/CD/CT (CCM only)		S A E P
Controls		
MX1 open	○	S A E P
XF close	○	S A E P
Measurements		
Instantaneous measurement information	○	A E P
Averaged measurement information	○	E P
Maximeter / minimeter	○	A E P
Energy metering	○	E P
Demand for current and power	○	E P
Power quality	○	
Operating assistance		
Protection and alarm settings		P
Histories		E P
Time stamped event tables		P
Maintenance indicators		A E P

Communication Modbus bus

The Modbus RS 485 (RTU protocol) system is an open bus on which communicating Modbus devices are installed. All types of PLCs and microcomputers may be connected to the bus.

Addresses

The Modbus communication parameters (address, baud rate, parity) are entered using the keypad on the A, E, P. For a switch-disconnector, it is necessary to use the RSU (Remote Setting Utility) control unit utility.

Modbus addresses

@xx	Circuit breaker manager	(1 to 47)
@xx + 50	Chassis manager	(51 to 97)
@xx + 200	Measurement manager	(201 to 247)
@xx + 100	Protection manager	(101 to 147)

The manager addresses are automatically derived from the circuit breaker address @xx entered via the control unit (the default address is 47).

Number of devices

The maximum number of devices that may be connected to the Modbus bus depends on the type of device, the baud rate (19200 is recommended), the volume of data exchanged and the desired response time. The RS 485 physical layer offers up to 32 connection points on the bus (1 master, 31 slaves).

A fixed device requires only one connection point (communication module on the device). A drawout device uses two connection points (communication modules on the device and on the chassis).

The number must never exceed 31 fixed devices or 15 drawout devices.

Length of bus

The maximum recommended length for the Modbus bus is 1200 meters.

Bus power source

A 24 V DC power supply is required (less than 20 % ripple, insulation class II).



S: Without measurement.

A: With ammeter

E: "Energy"

P: "Power"

Note: see the description of the control units for further details on protection and alarms, measurements, waveform capture, histories, logs and maintenance indicators.

Molded Case Circuit Breakers BX series (800AF to 1600AF) Communication

■ Networks

Modbus

Modbus is the most widely used communication protocol in industrial networks.

It operates in master-slave mode. The devices (slaves) communicate one after the other with a gateway (master). BX and DW products all operate with this protocol. A Modbus network is generally implemented on an LV or MV switchboard scale. Depending on the data monitored and the desired refresh rate, a Modbus network connected to a gateway can serve 4 to 16 devices. For larger installations, a number of Modbus networks can be connected to an Ethernet network (TCP/IP/Modbus) via their gateways.

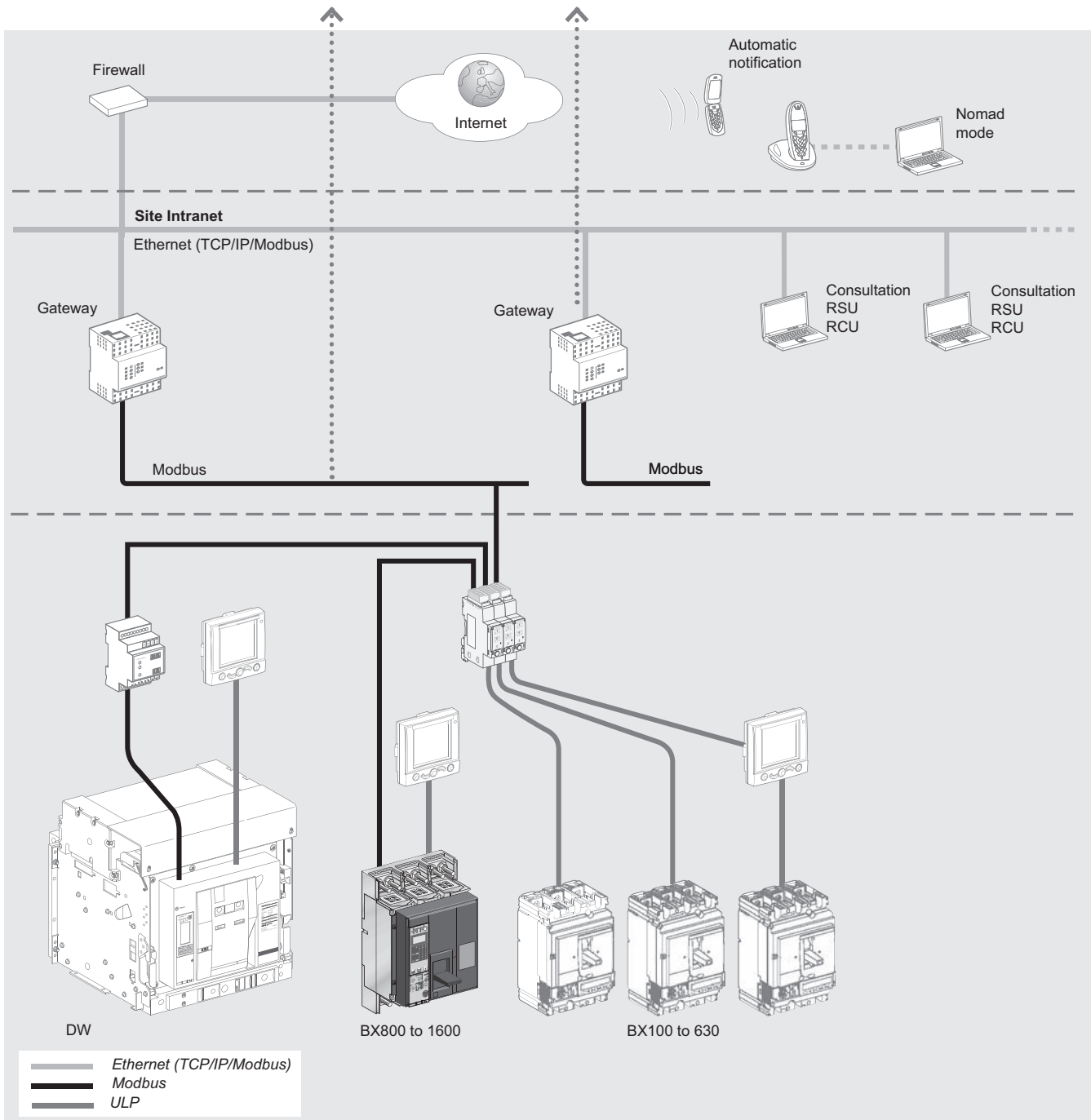

Molded Case Circuit Breakers BX series (800AF to 1600AF) Electrical and mechanical accessories

■ BX800 to 1600 (fixed version)

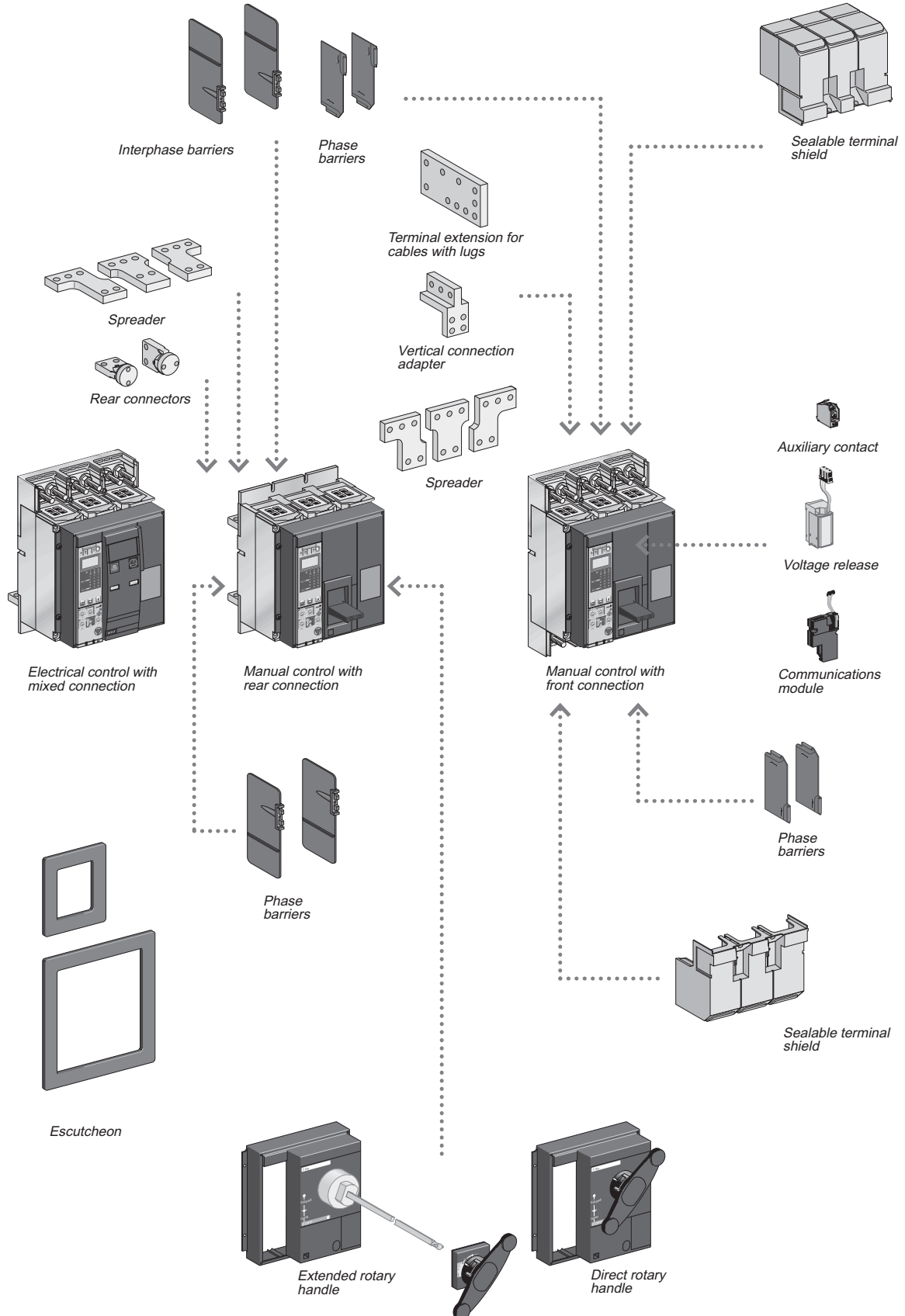

Molded Case Circuit Breakers

BX series (800AF to 1600AF)

Electrical and mechanical accessories

■ BX800 to 1600

Installation

• Fixed configuration

BX800 to 1600 circuit breakers may be installed vertically, horizontally or flat on their back.

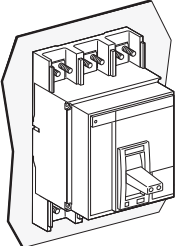

Mounting on a backplate.

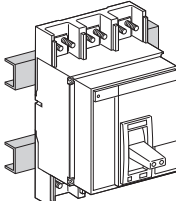

Mounting on rails.



Fixed BX800

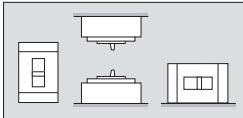

Molded Case Circuit Breakers BX series (800AF to 1600AF) Electrical and mechanical accessories

• Types of connection

Fixed device

Front connections (N, L)

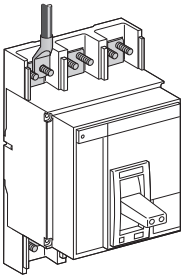

Connection by: bars



bare cables (except L)



cables with lugs

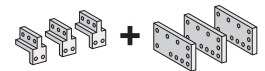
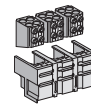

Rear connections (N, L, LB)

Horizontal:

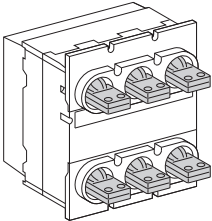

Vertical:

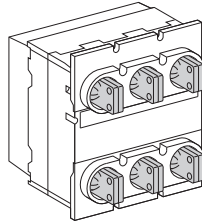

Connection by: bars



cables with lugs

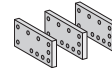

Simply turn a horizontal rear connector 90° to make it a vertical connector.

Combination of front and rear connections (N, L)

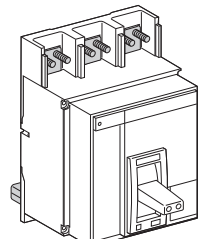
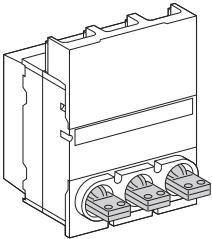

Connection by: bars



bare cables (except L)



cables with lugs

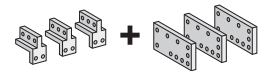
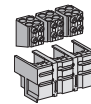

Molded Case Circuit Breakers BX series (800AF to 1600AF) Electrical and mechanical accessories

• Connections accessories

Front connection of fixed devices

Bars

Fixed, front-connection BX800 to 1600 devices are equipped with terminals comprising captive screws for direct connection of bars.

Other connection possibilities for bars include vertical-connection adapters for edgewise bars and spreaders to increase the pole pitch to 95 mm.

If the vertical connection adapters are front oriented, then it is mandatory to install the arc chute screen in order to comply with the safety clearances.

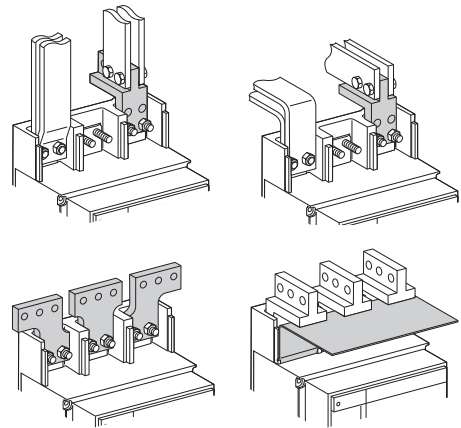
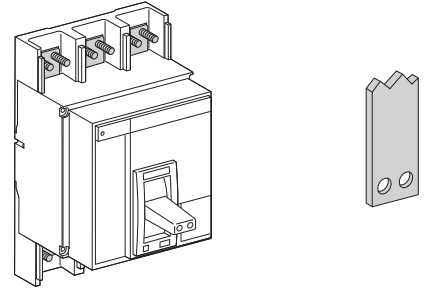
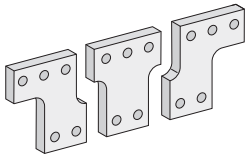

Bare cables

Special sets of connectors and terminal shields may be used to connect up to four 240 mm² copper or aluminium cables for each phase. Bare cable connection is possible for ratings up to and including 1250 A.

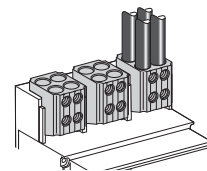
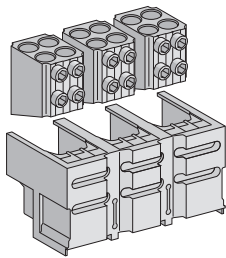

Molded Case Circuit Breakers

BX series (800AF to 1600AF)

Electrical and mechanical accessories

Rear connection of fixed devices

Bars

Fixed, rear-connection BX800 to 1600 devices equipped with horizontal or vertical connectors may be directly connected to flat or edgewise bars, depending on the position of the connectors.

Spreaders are available to increase the pole pitch to 95 mm.

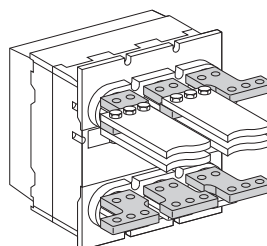
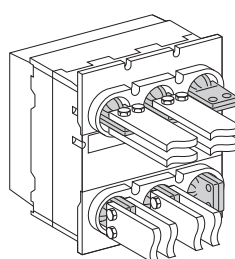
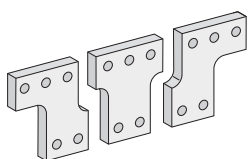
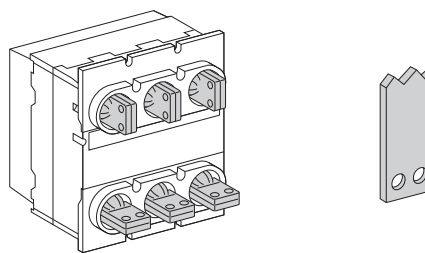

Cables with lugs

Cable lug adapters enable connection of one to four cables with crimped lugs ($\leq 300 \text{ mm}^2$).

To ensure stability, spacers must be positioned between the terminal extensions.

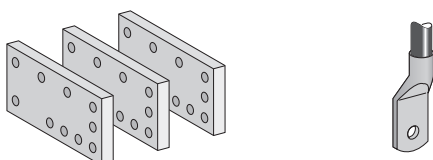

Molded Case Circuit Breakers BX series (800AF to 1600AF) Electrical and mechanical accessories

Rear connection of fixed devices

Bars

Fixed, rear-connection BX800 to 1600 devices equipped with horizontal or vertical connectors may be directly connected to flat or edgewise bars, depending on the position of the connectors.

Spreaders are available to increase the pole pitch to 95 mm.

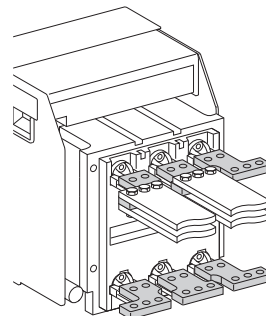
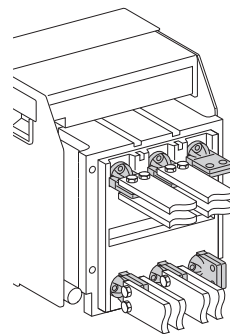
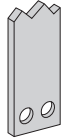
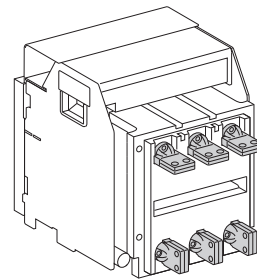
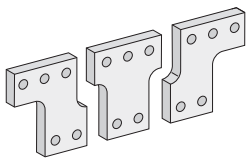

Molded Case Circuit Breakers BX series (800AF to 1600AF) Electrical and mechanical accessories

Interphase barriers

These barriers are flexible insulated partitions used to reinforce isolation of connection points in installations with busbars, whether insulated or not.

Barriers are installed vertically between front or rear connection terminals.

They are mandatory for voltages ≥ 500 V for both fixed and withdrawable products and for L and LB types, whatever the voltage.

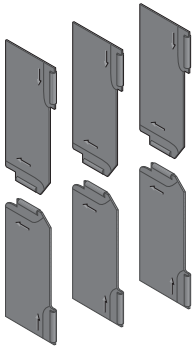

Interphase barriers for fixed device, front connection

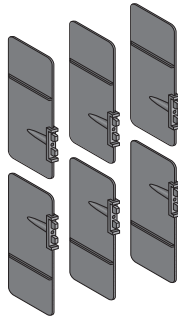

Interphase barriers for fixed device, rear connection.

Connection of electrical auxiliaries

Fixed devices

Connections are made directly to the auxiliaries once the front has been removed. Wires exit the circuit breaker through a knock-out in the top.

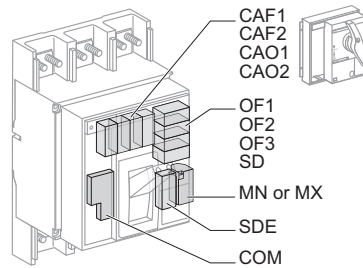
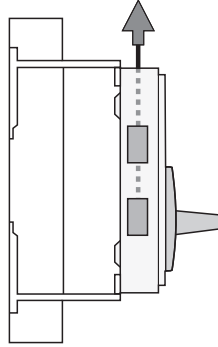

Manually operated device.

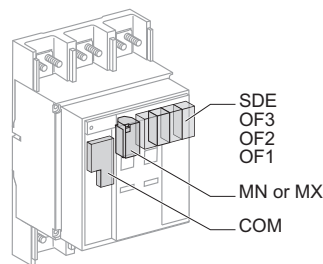

Electrically operated device.

Indication contacts

Contacts installed in the device

Changeover contacts are used to remote circuit breaker status information and can thus be used for indications, electrical locking, relaying, etc.

They comply with the IEC 60947-5 international recommendation.

Functions

■ **OF (ON/OFF)** - indicates the position of the main circuit breaker contacts

■ **SD (trip indication)** - indicates that the circuit breaker has tripped due to:

- an overload
- a short-circuit
- an earth-leakage fault.
- operation of a voltage release
- operation of the «push to trip» button
- disconnection when the device is ON.

Returns to de-energised state when the circuit breaker is reset.

■ **SDE (fault indication)** - indicates that the circuit breaker has tripped due to:

- an overload
- a short-circuit
- an earth-leakage fault.

Returns to de-energised state when the circuit breaker is reset.

Installation

■ **OF, SD and SDE functions** - a single type of contact provides all these different indication functions, depending on where it is inserted in the device. The contacts clip into slots behind the front cover of the circuit breaker

Electrical characteristics of the OF/SD/SDE auxiliary contacts

Contacts	Standard				Low level				
Rated thermal current (A)	6				5				
Minimum load	100 mA at 24 V				1 mA at 4 V				
Utilisation cat. (IEC 60947-5-1)	AC12	AC15	DC12	DC14	AC12	AC15	DC12	DC14	
Operational current (A)	24 V	6	6	6	1	5	3	5	1
	48 V	6	6	2.5	0.2	5	3	2.5	0.2
	110 V	6	5	0.6	0.05	5	2.5	0.6	0.05
	220/240 V	6	4	-	-	5	2	-	-
	250 V	-	-	0.3	0.03	5	-	0.3	0.03
	380/440 V	6	2	-	-	5	1.5	-	-
	480 V	6	1.5	-	-	5	1	-	-
660/690 V	6	0.1	-	-	-	-	-	-	

All the auxiliary contacts opposite are also available in "low-level" versions capable of switching very low loads (e.g. for the control of PLCs or electronic circuits).



OF, SD and SDE changeover contacts.

Rotary handles

There are two types of rotary handle:

- direct rotary handle
- extended rotary handle.

There are two models:

- standard with a black handle
- VDE with a red handle and yellow front for machine-tool control.

Direct rotary handle

Degree of protection IP40, IK07.

The direct rotary handle maintains:

- visibility of and access to trip unit settings
- suitability for isolation
- indication of the three positions O (OFF), I (ON) and tripped
- access to the «push to trip» button
- circuit breaker locking capability in the OFF position by one to three padlocks, shackle diameter 5 to 8 mm (not supplied).

It replaces the circuit breaker front cover.

Accessories transform the standard direct rotary handle for the following situations:

- a higher degree of protection (IP43, IK07)
- machine-tool control, complying with CNOMO E03.81.501, IP54, IK07.

Extended rotary handle

Degree of protection IP55, IK07.

This handle makes it possible to operate circuit breakers installed at the back of switchboards, from the switchboard front.

It maintains:

- suitability for isolation
- indication of the three positions O (OFF), I (ON) and tripped
- access to trip unit settings, when the switchboard door is open
- circuit breaker locking capability in the OFF position by one to three padlocks, shackle diameter 5 to 8 mm (not supplied).

The door cannot be opened if the circuit breaker is ON or locked.

The extended rotary handle is made up of:

- a unit that replaces the front cover of the circuit breaker (secured by screws)
- an assembly (handle and front plate) on the door that is always secured in the same position, whether the circuit breaker is installed vertically or horizontally
- an extension shaft that must be adjusted to the distance. The min/max distance between the back of circuit breaker and door is 218/605 mm.



BX with a direct rotary handle.

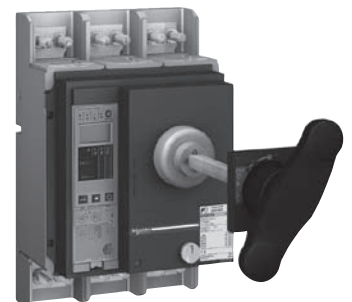

BX with an extended rotary handle.

Molded Case Circuit Breakers BX series (800AF to 1600AF) Electrical and mechanical accessories

Remote tripping

This function opens the circuit breaker via an electrical order. It is made up of:

- a shunt release (2nd MX)

- or an undervoltage release MN

- or a delayed undervoltage release MN + delay unit.

These releases (2nd MX or MN) cannot be operated by the communication bus.

The delay unit, installed outside the circuit breaker, may be disabled by an emergency OFF button to obtain instantaneous opening of the circuit breaker.

Wiring diagram for the remote-tripping function

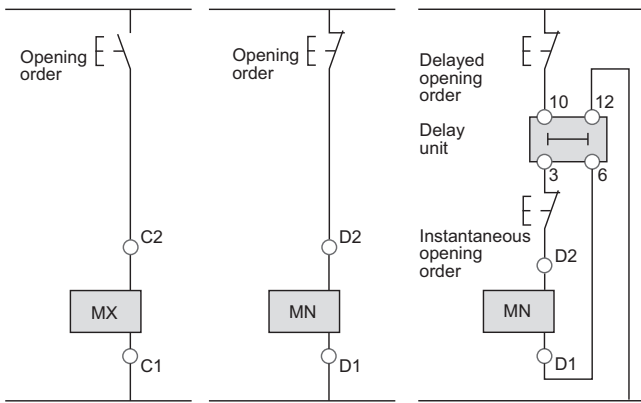

Voltage releases 2nd MX

When energised, the 2nd MX voltage release instantaneously opens the circuit breaker. A continuous supply of power to the 2nd MX locks the circuit breaker in the OFF position.

Characteristics		
Power supply	V AC 50/60 Hz	24 - 48 - 100/130 - 200/250 - 277 - 380/480
	V DC	12 - 24/30 - 48/60 - 100/130 - 200/250
Operating threshold	0.7 to 1.1 Un	
Permanent locking function	0.85 to 1.1 Un	
Consumption (VA or W)	pick-up: 200 (200 ms) hold: 4.5	
Circuit breaker response time at Un	50 ms ±10	

Instantaneous voltage releases MN

The MN release instantaneously opens the circuit breaker when its supply voltage drops to a value between 35 % and 70 % of its rated voltage. If there is no supply on the release, it is impossible to close the circuit breaker, either manually or electrically. Any attempt to close the circuit breaker has no effect on the main contacts. Circuit breaker closing is enabled again when the supply voltage of the release returns to 85 % of its rated value.

Characteristics		
Power supply	V AC 50/60 Hz	24 - 48 - 100/130 - 200/250 - 380/480
	V DC	24/30 - 48/60 - 100/130 - 200/250
Operating threshold	opening	0.35 to 0.7 Un
	closing	0.85 Un
Consumption (VA or W)	pick-up: 200 (200 ms) hold: 4.5	
	MN consumption with delay unit (VA or W) pick-up: 400 (200 ms) hold: 4.5	
Circuit breaker response time at Un	90 ms ±5	

MN delay units

To eliminate circuit breaker nuisance tripping during short voltage dips, operation of the MN release can be delayed. This function is achieved by adding an external delay unit in the MN voltage-release circuit. Two versions are available, adjustable and non-adjustable.

Characteristics		
Power supply V AC 50-60 Hz /DC	non-adjustable	100/130 - 200/250
	adjustable	48/60 - 100/130 - 200/250 - 380/480
Operating threshold	opening	0.35 to 0.7 Un
	closing	0.85 Un
Consumption of delay unit alone (VA or W)	pick-up: 200 (200 ms)	hold: 4.5
Circuit breaker response time at Un	non-adjustable	0.25 s
	adjustable	0.5 s - 0.9 s - 1.5 s - 3 s

Manually operated circuit breakers may be equipped with an MX shunt release, an MN undervoltage release or a delayed undervoltage release (MN + delay unit).

Electrically operated circuit breakers are equipped as standard with a remote-operating mechanism to remotely open or close the circuit breaker. An MX shunt release or an MN undervoltage release (instantaneous or delayed) may be added.



MX voltage release.

Molded Case Circuit Breakers BX series (800AF to 1600AF) Electrical and mechanical accessories

Electrically operated circuit breaker

The motor mechanism module is used to remotely open and close the circuit breaker. It is made up of a spring-charging motor equipped with an opening release and a closing release. An electrical operation function is generally combined with:

- device ON/OFF indication OF
- "fault-trip" indication SDE.

Motor mechanism module		
Power supply	V AC 50/60 Hz	48/60 - 100/130 - 200/240 - 277 - 380/415
	V DC	24/30 - 48/60 - 100/125 - 200/250
Operating threshold		0.85 to 1.1 Un
Consumption (VA or W)		180
Motor overcurrent		2 to 3 In for 0.1 second
Charging time		maximum 4 seconds
Operating frequency		maximum 3 cycles per minute

Electrical closing order

The release remotely closes the circuit breaker if the spring mechanism is charged.

Release electrical characteristics are identical to those of an MX release (see above), the operating threshold is from 0.85 to 1.1 Un and the circuit breaker response time at Un is 60 ms \pm 10.

The BX electrical operation function can be used to implement a synchro-coupling system.

Electrical opening order

The release instantaneously opens the circuit breaker when energised. The supply can be impulse-type or maintained.

Release electrical characteristics are identical to those of an MX release (see above).

Electrically operated circuit breakers are equipped as standard with a motor mechanism module.

Two solutions are available for electrical operation:

- a point-to-point solution
- a bus solution with the COM communication option.



Electrically operated BX circuit breaker

Wiring diagram of a bus-type electrical operation solution

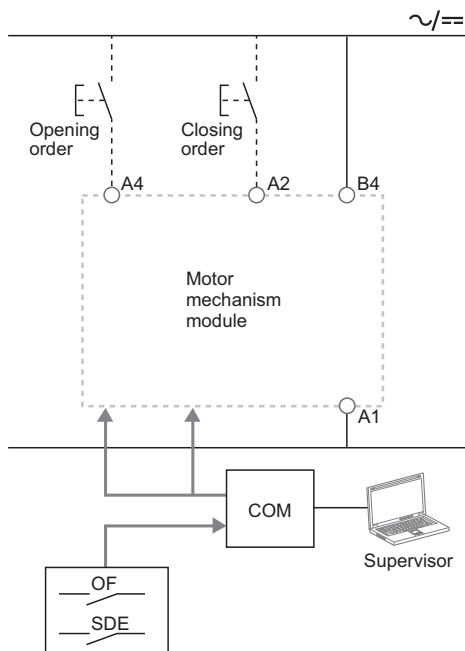

In the event of simultaneous opening and closing orders, the mechanism discharges without any movement of the main contacts. In the event of maintained opening and closing orders, the standard electrical operation solution provides an anti-pumping function by blocking the main contacts in open position.

Wiring diagram of a point-to-point electrical operation solution

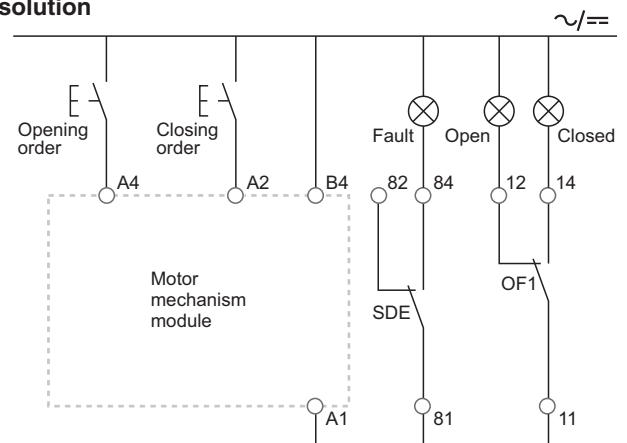

Molded Case Circuit Breakers BX series (800AF to 1600AF) Operating conditions

■ Operating conditions

Altitude derating

Altitude does not significantly affect circuit-breaker characteristics up to 2000 m.

Above this altitude, it is necessary to take into account the decrease in the dielectric strength and cooling capacity of air. The following table gives the corrections to be applied for altitudes above 2000 metres. The breaking capacities remain unchanged.

BX800 to 1600

Altitude (m)	2000	3000	4000	5000
Impulse withstand voltage U_{imp} (kV)	8	7.1	6.4	5.6
Rated insulation voltage (U_i)	800	710	635	560
Maximum rated operational voltage 50/60 Hz U_e (V)	690	690	635	560
Rated current 40 °C	$1 \times I_n$	$0.99 \times I_n$	$0.96 \times I_n$	$0.94 \times I_n$

Intermediate values may be obtained by interpolation.

Vibrations

BX devices resist electromagnetic or mechanical vibrations. Tests are carried out in compliance with standard EC 60068-2-6 for the levels required by merchant-marine inspection organisations (Veritas, Lloyd's, etc.):

- 2 V ➔ 13.2 Hz: amplitude ± 1 mm
 - 13.2 V ➔ 100 Hz: constant acceleration 0.7 g.
- Excessive vibration may cause tripping, breaks in connections or damage to mechanical parts.

Electromagnetic disturbances

BX devices are protected against:

- overvoltages caused by devices that generate electromagnetic disturbances
- overvoltages caused by an atmospheric disturbances or by a distribution-system outage (e.g. failure of a lighting system)
- devices emitting radio waves (radios, walkie-talkies, radar, etc.)
- electrostatic discharges produced by users.

BX devices have successfully passed the electromagnetic-compatibility tests (EMC) defined by the following international standards:

- IEC 60947-2, appendix F
- IEC 60947-2, appendix B (trip units with Vigi earth-leakage function).

The above tests guarantee that:

- no nuisance tripping occurs
- tripping times are respected.

BX circuit breakers have been tested for operation in industrial atmospheres.

It is recommended that the equipment be cooled or heated to the proper operating temperature and kept free of excessive vibration and dust.

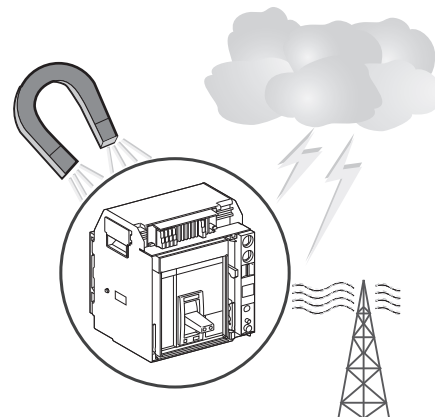
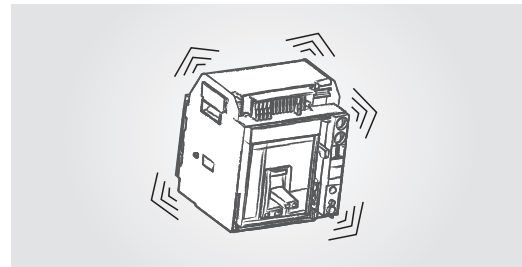
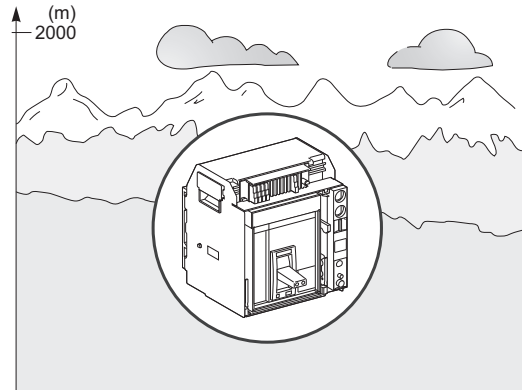

Molded Case Circuit Breakers BX series (800AF to 1600AF) Installation in switchboards

■ Power supply and mass

Power supply

BX circuit breakers can be supplied from either the top or the bottom without any reduction in performance. This capability facilitates connection when installed in a switchboard.

Mass

Type of device		Circuit breakers
BX800 to 1600	3P	14
manual operation	4P	18
BX800 to 1600	3P	14
electrical operation	4P	18

The table above presents the mass (in kg) of the circuit breakers and the main accessories, which must be summed to obtain the total mass of complete configurations.

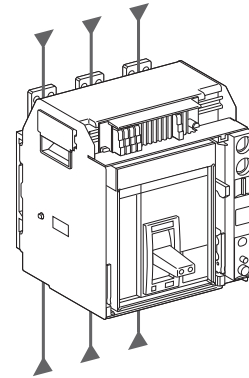

Molded Case Circuit Breakers BX series (800AF to 1600AF) Installation in switchboards

■ Safety clearances and minimum distances

General rules

When installing a circuit breaker, minimum distances (safety clearances) must be maintained between the device and panels, bars and other protection devices installed nearby. These distances, which depend on the ultimate breaking capacity, are defined by tests carried out in accordance with standard IEC 60947-2.

If installation conformity is not checked by type tests, it is also necessary to:

- use insulated bars for circuit-breaker connections
- block off the busbars using insulating screens.

BX800 to 1600 (fixed devices)

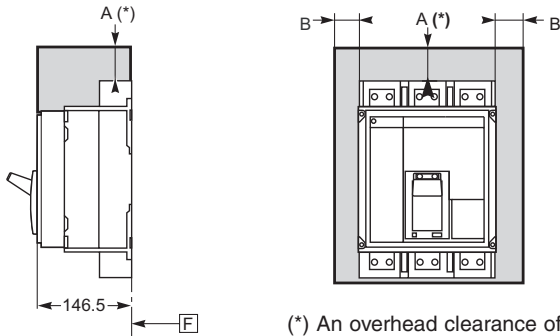

(*) An overhead clearance of 50 mm is required to remove the arc chutes.

	Insulated parts	Metal parts	Live parts
A	0	120	180
B	0	10	60

[F] Datum

Molded Case Circuit Breakers BX series (800AF to 1600AF) Installation in switchboards

■ Installation example

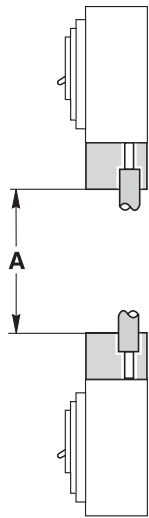

Direct connection by bare cables, devices with terminal shields.

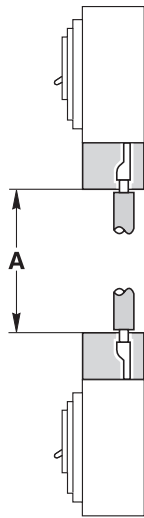

Connection by cables with lugs, devices with terminal shields.

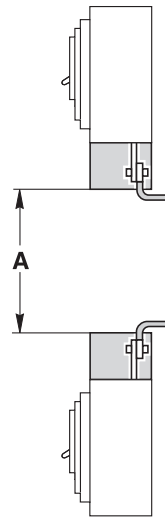

Connection by insulated bars, devices with terminal shields.

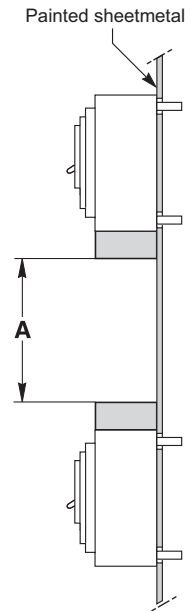

Rear connection or plug-in base, devices with terminal shields.

Minimum dimensions (mm)	A
BX800 to 1600	250
BX1600b to 3200	300

Molded Case Circuit Breakers

BX series (800AF to 1600AF)

Control wiring

■ Control wiring

• Wiring of voltage releases

During pick-up, the power consumed is approximately 150 to 200 VA.

For low control voltages (12, 24, 48 V), maximum cable lengths are imposed by the voltage and the cross-sectional area of cables.

Recommended maximum cable lengths (meter).

		12 V		24 V		48 V	
		2.5 mm ²	1.5 mm ²	2.5 mm ²	1.5 mm ²	2.5 mm ²	1.5 mm ²
MN	U source 100 %	-	-	58	35	280	165
	U source 85 %	-	-	16	10	75	45
MX-XF	U source 100 %	21	12	115	70	550	330
	U source 85 %	10	6	75	44	350	210

Note: the indicated length is that of each of the two wires.

• 24 V DC power-supply module

External 24 V DC power-supply module for control unit (F1-, F2+)

- Do not connect the positive terminal (F2+) to earth.
- The negative terminal (F1-) can be connected to earth, except in IT systems.
- A number of control units and M6C modules can be connected to the same 24 V DC power supply (the consumption of a control unit or an M6C module is approximately 100 mA).
- Do not connect any devices other than a control unit or an M6C module if voltage > 480 V AC or in an environment with high level of electromagnetic disturbance.
- The maximum length for each conductor is ten metres. For greater distances, it is advised to twist the supply wires together.
- The 24 V DC supply wires must cross the power cables perpendicularly. If this is difficult, it is advised to twist the supply wires together.
- The technical characteristics of the external 24 V DC power-supply module for control units are indicated on *page 106*.

Communication bus

- Do not connect the positive terminal (E1) to earth.
- The negative terminal (E2) can be connected to earth.
- A number of "device" or "chassis" communication modules can be connected to the same 24 V DC power supply (the consumption of each module is approximately 30 mA).

Note: wiring of ZSI: it is recommended to use twisted shielded cable. The shield must be connected to earth at both ends.

Molded Case Circuit Breakers BX series (800AF to 1600AF) Temperature derating

■ BX devices equipped with electronic trip units

BX800 to 1600 ⁽¹⁾

The table below indicates the maximum rated-current value for each type of connection, depending on the ambient temperature. For mixed connections, use the same derating values as for horizontal connections.

Version Connection temp. T _i ⁽²⁾	Fixed device													
	Front or horizontal rear							Vertical rear						
	40	45	50	55	60	65	70	40	45	50	55	60	65	70
BX800	800	800	800	800	800	800	800	800	800	800	800	800	800	800
BX1000	1000	1000	1000	1000	1000	1000	1000	1000	1000	1000	1000	1000	1000	1000
BX1250	1250	1250	1250	1250	1250	1240	1090	1250	1250	1250	1250	1250	1250	1180
BX1600	1600	1600	1560	1510	1470	1420	1360	1600	1600	1600	1600	1600	1510	1460

Version Connection temp. T _i ⁽²⁾	Withdrawable device													
	Front or horizontal rear							Vertical rear						
	40	45	50	55	60	65	70	40	45	50	55	60	65	70
BX800	800	800	800	800	800	800	800	800	800	800	800	800	800	800
BX1000	1000	1000	1000	1000	1000	1000	920	1000	1000	1000	1000	1000	1000	990
BX1250	1250	1250	1250	1250	1250	1170	1000	1250	1250	1250	1250	1250	1250	1090
BX1600	1600	1600	1520	1480	1430	1330	1160	1600	1600	1600	1560	1510	1420	1250

(1) For a circuit breaker mounted in horizontal position, the derating to be applied is equivalent to that of a front or horizontal rear connected circuit breaker.

(2) T_i: temperature around the circuit breaker and its connections.

BX circuit breakers have been tested for operation in industrial atmospheres.

It is recommended that the equipment be cooled or heated to the proper operating temperature and kept free of excessive vibration and dust.

Molded Case Circuit Breakers

BX series (800AF to 1600AF)

Power dissipation / Resistance

■ BX devices equipped with electronic trip units

BX800 to 1600

Version	Fixed device	
	R	
	R/pole	P/pole
BX800	0.026	15
BX1000	0.026	22
BX1250	0.026	44
BX1600	0.026	74

The values indicated in the tables opposite are typical values.

Power dissipated per pole (P/pole) in Watts (W)

The value indicated in the table is the power dissipated at I_N , 50/60 Hz, for a three-pole or four-pole circuit breaker (these values can be higher than the power calculated on the basis of the pole resistance). Measurement and calculation of the dissipated power are carried out in compliance with the recommendations of Annex G of standard IEC 60947-2.

Resistance per pole (R/pole) in milliohms ($m\Omega$)

The value of the resistance per pole is provided as a general indication for a new device.

The value of the contact resistance must be determined on the basis of the measured voltage drop, in accordance with the manufacturer's test procedure (expert card ABT no. FE 05e).

Note: this measurement is not sufficient to determine the quality of the contacts, i.e. the capacity of the circuit breaker to carry its rated current.

Molded Case Circuit Breakers BX series (800AF to 1600AF) Dimensions and mounting

■ BX800 to 1600 (fixed version) • Dimensions

Manual control Front connection (R)

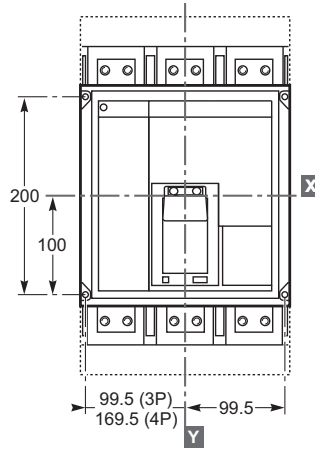
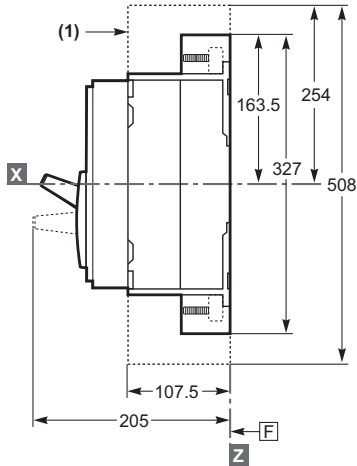

(1) terminal shields are optional.

Rear connection (R)

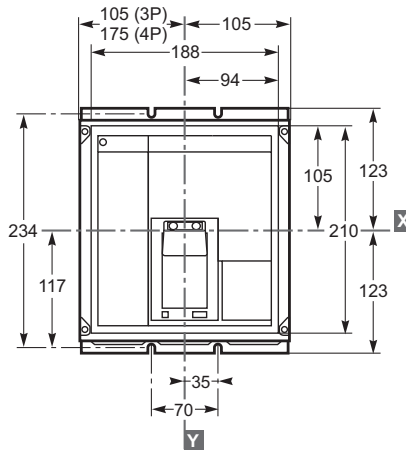
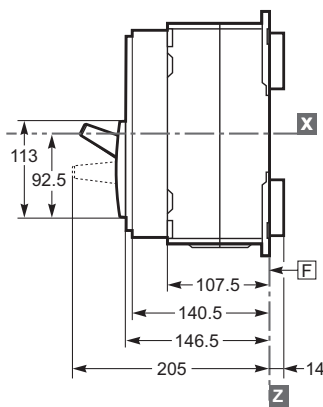

Electrical control Front and rear connection (R)

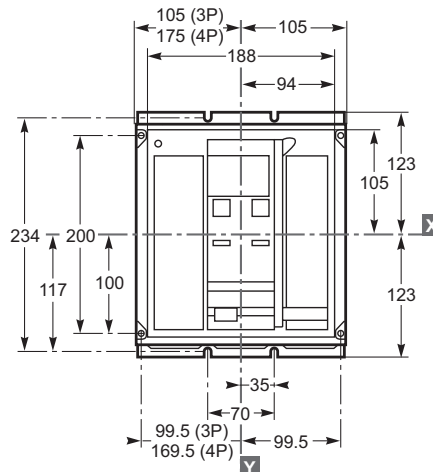
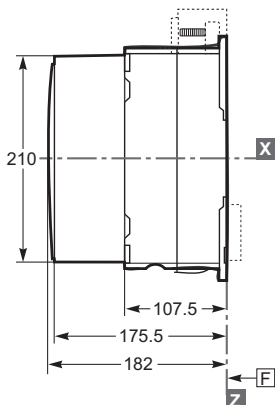

F : Datum.

Note: Dimensions for front and rear connection on electrically operated devices are identical to those for manually operated devices.

Molded Case Circuit Breakers BX series (800AF to 1600AF) Dimensions and mounting

• Mounting

Front connection
On backplate

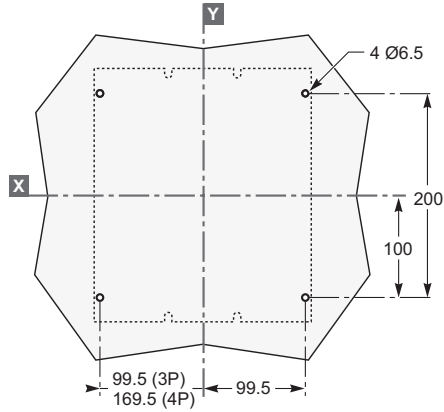

On rails

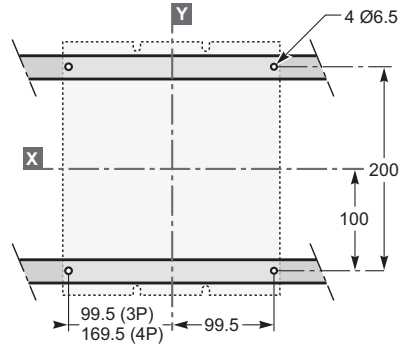

Rear connection
On backplate

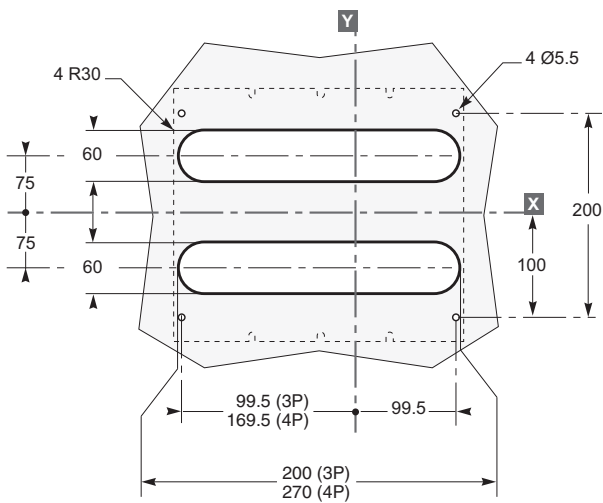

On rails

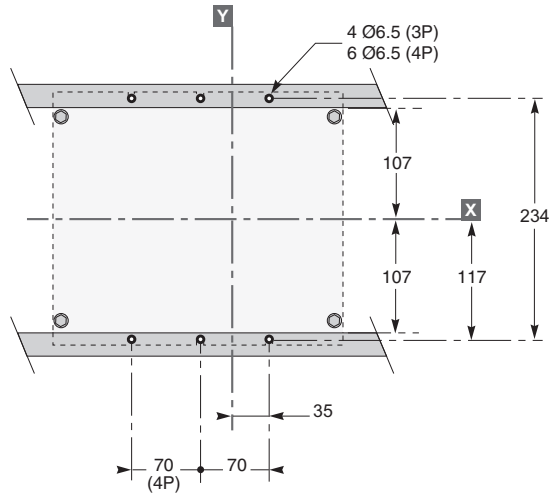

Note: Mounting parameters for electrically operated devices are identical to those for manually operated devices.

X and Y are the symmetry planes for a 3-pole device

Z is the back plane of the device.

Molded Case Circuit Breakers BX series (800AF to 1600AF) Dimensions and mounting

■ BX800 to 1600 (fixed version)
• Front-panel cutouts

Toggle control

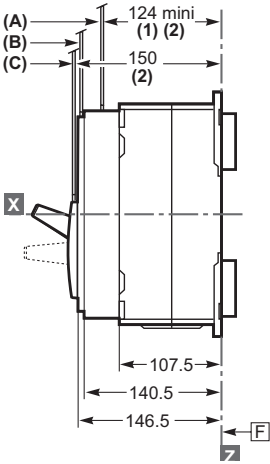

F : Datum.
(1) Without escutcheon.
(2) With escutcheon.

Door cutout

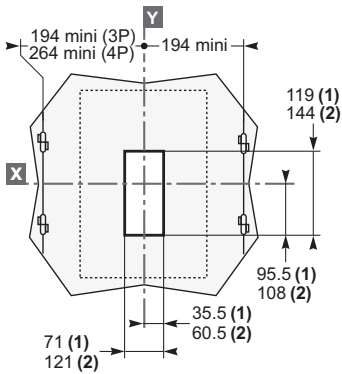
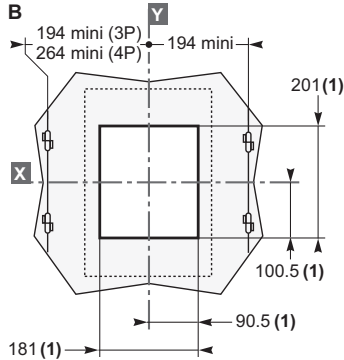
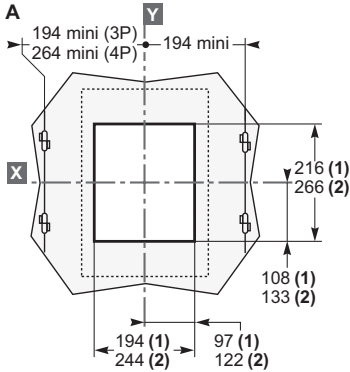

Electrical control

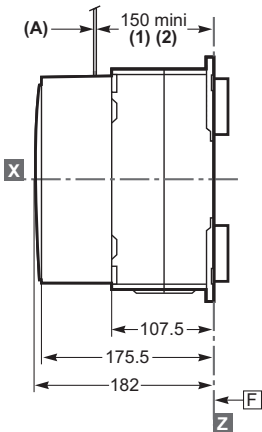

F : Datum.
(1) Without escutcheon.
(2) With escutcheon.

Door cutout

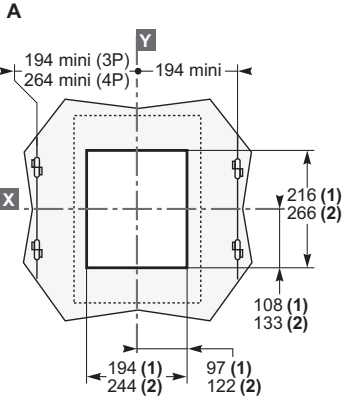

Molded Case Circuit Breakers BX series (800AF to 1600AF) Dimensions and mounting

• Rotary handle

Direct rotary handle

Dimensions

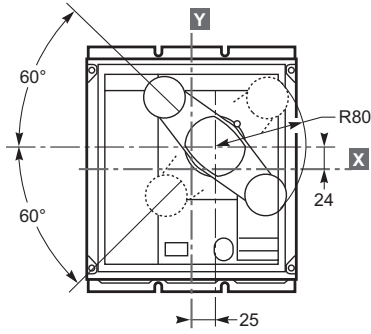
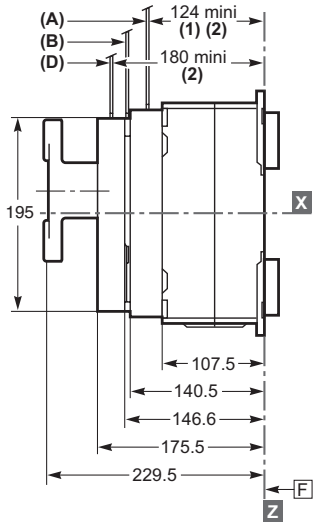

Door cutout

A

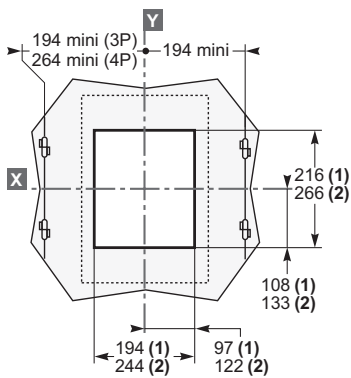

B

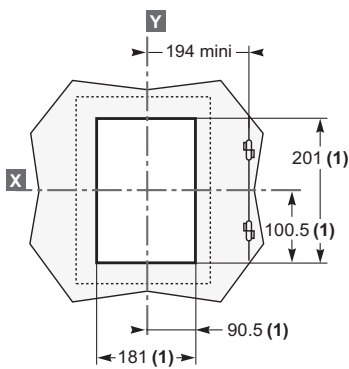

D

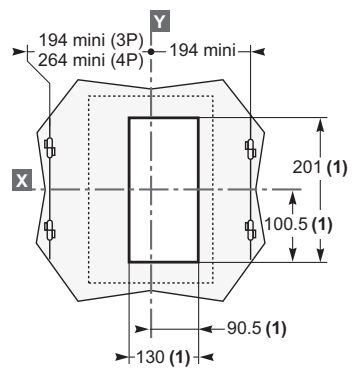

(1) Without escutcheon.
(2) With escutcheon.

Extended rotary handle

Dimensions

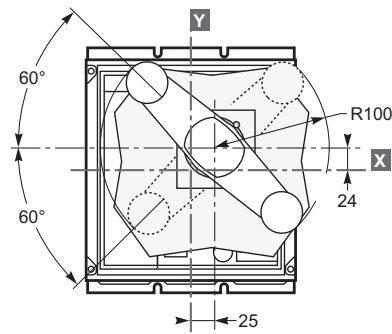
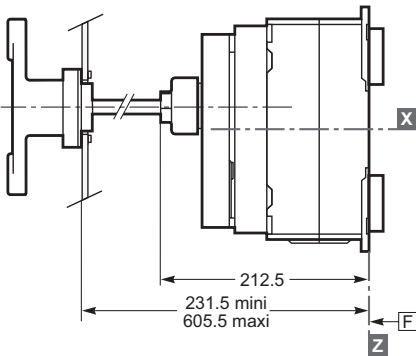

Door cutout

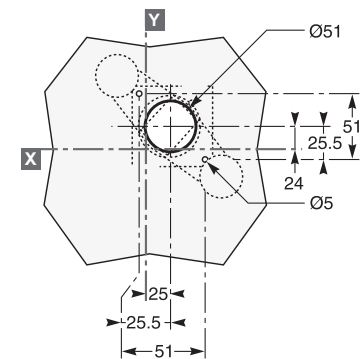

F : Datum.

Note: X and Y are the symmetry planes for a 3-pole device Z is the back plane of the device.

Molded Case Circuit Breakers BX series (800AF to 1600AF) Dimensions and mounting

• External modules (cont.)

Rectangular sensor for earth leakage protection

470 x 160 mm window

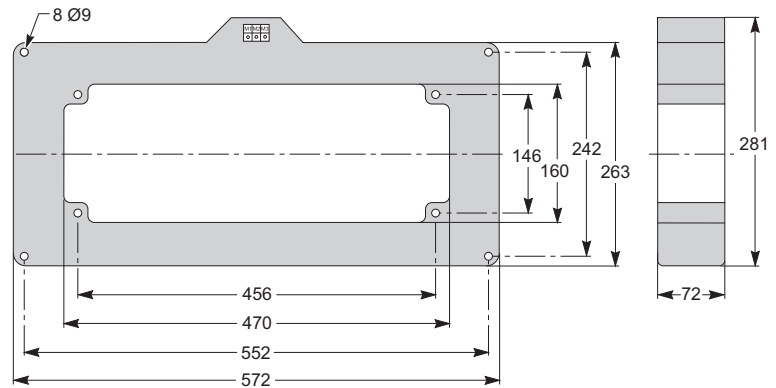
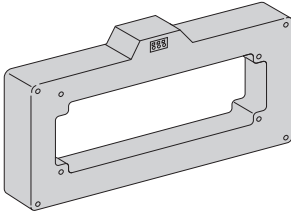

Busbars	I ≤ 1600 A
Window (mm)	280 x 115
Mass (kg)	14

Busbars path

470 x 160 mm window

Busbars spaced 115 mm centre-to-centre

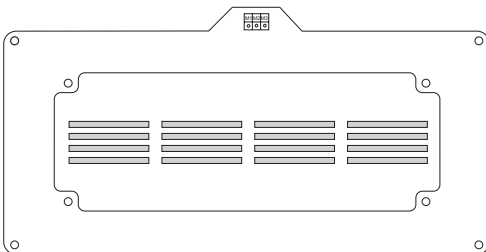

4 bars 100 x 5

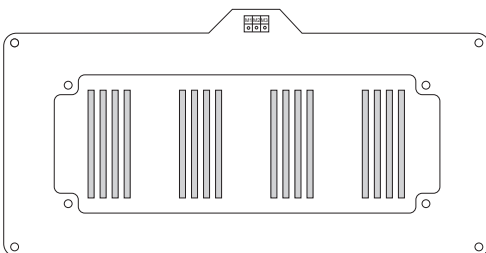

4 bars 125 x 5

Molded Case Circuit Breakers BX series (800AF to 1600AF) Dimensions and mounting

■ Accessories BX800 to 1600

Escutcheon BX800 to 1600 (fixed control)

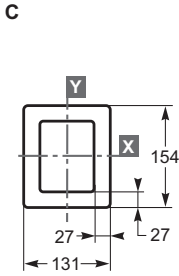
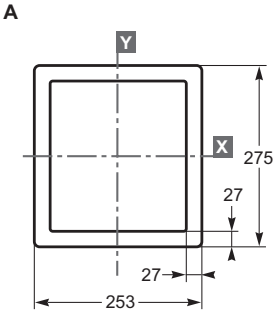
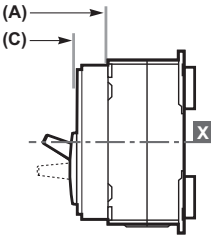

Molded Case Circuit Breakers BX series (800AF to 1600AF) Power connections

■ BX800 to 1600 (fixed version) • Bars

Horizontal rear connection

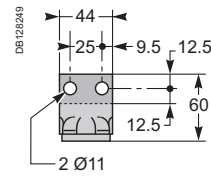
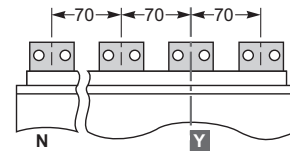
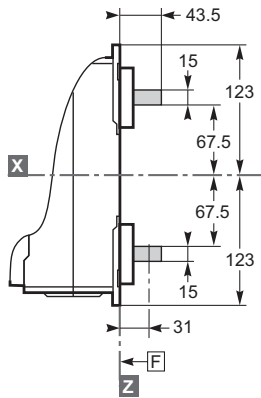
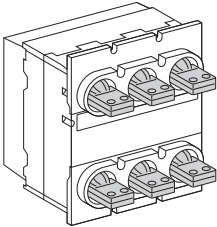

Vertical rear connection

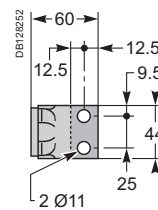
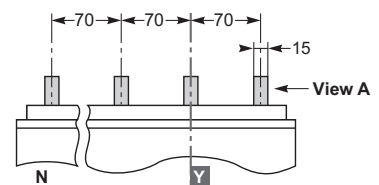
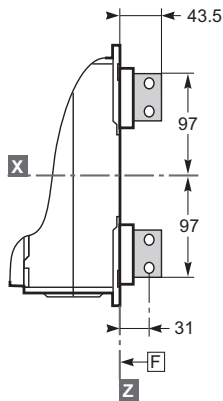
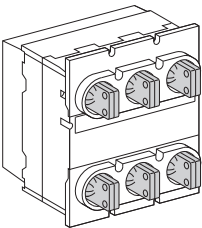

View A detail.

Front connection

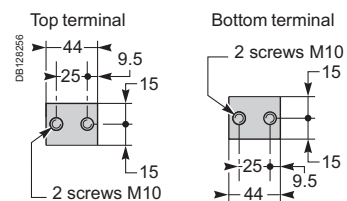
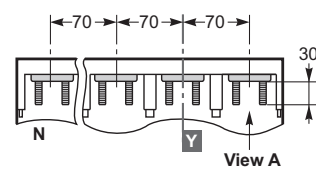
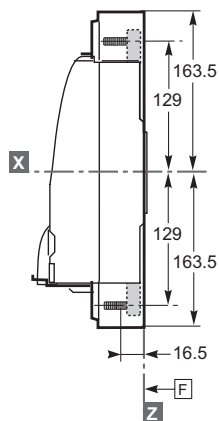
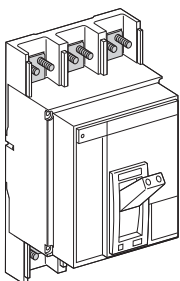

View A detail.

F : Datum.

Note.
Recommended connection screws: **M10** class 8.8.
Tightening torque: **50 Nm** with contact washer.

Molded Case Circuit Breakers BX series (800AF to 1600AF) Power connections

■ BX800 to 1600 (fixed version)

• Bars

Front connection with spreaders

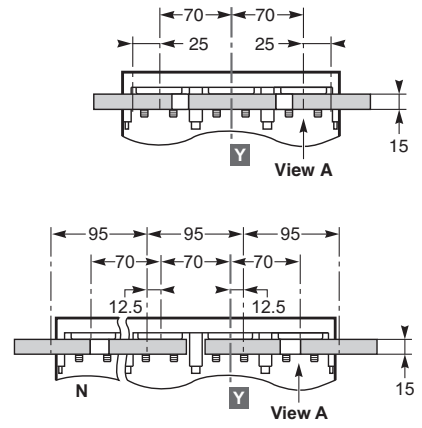
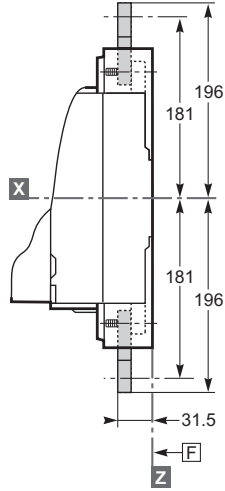
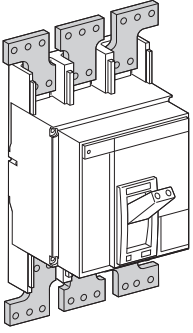

Spreader detail

Middle left or middle right spreader for 4P

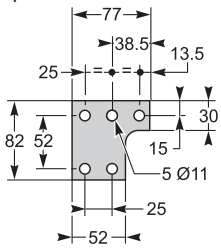

View A detail.

Middle spreader for 3P

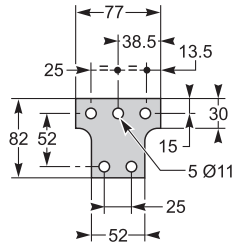

Left or right spreader for 4P

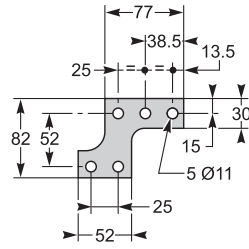

Left or right spreader for 3P

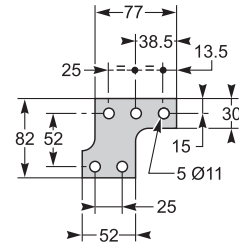

Note: X and Y are the symmetry planes for a 3-pole device.

F : Datum.

Molded Case Circuit Breakers BX series (800AF to 1600AF) Power connections

■ BX800 to 1600

• Recommended drilling dimensions

Rear connection

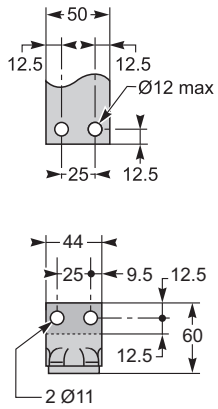

Vertical rear connection

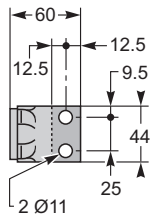

Front connection

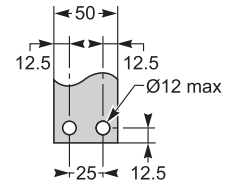

Top terminal

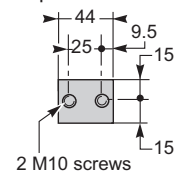

Bottom terminal

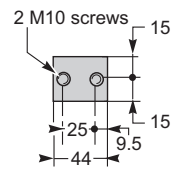

Molded Case Circuit Breakers

BX series (800AF to 1600AF)

Electrical diagrams

■ BX800 to 1600 Fixed circuit breakers

The diagram is shown with circuits de-energised, all devices open, connected and charged and relays in the normal position.

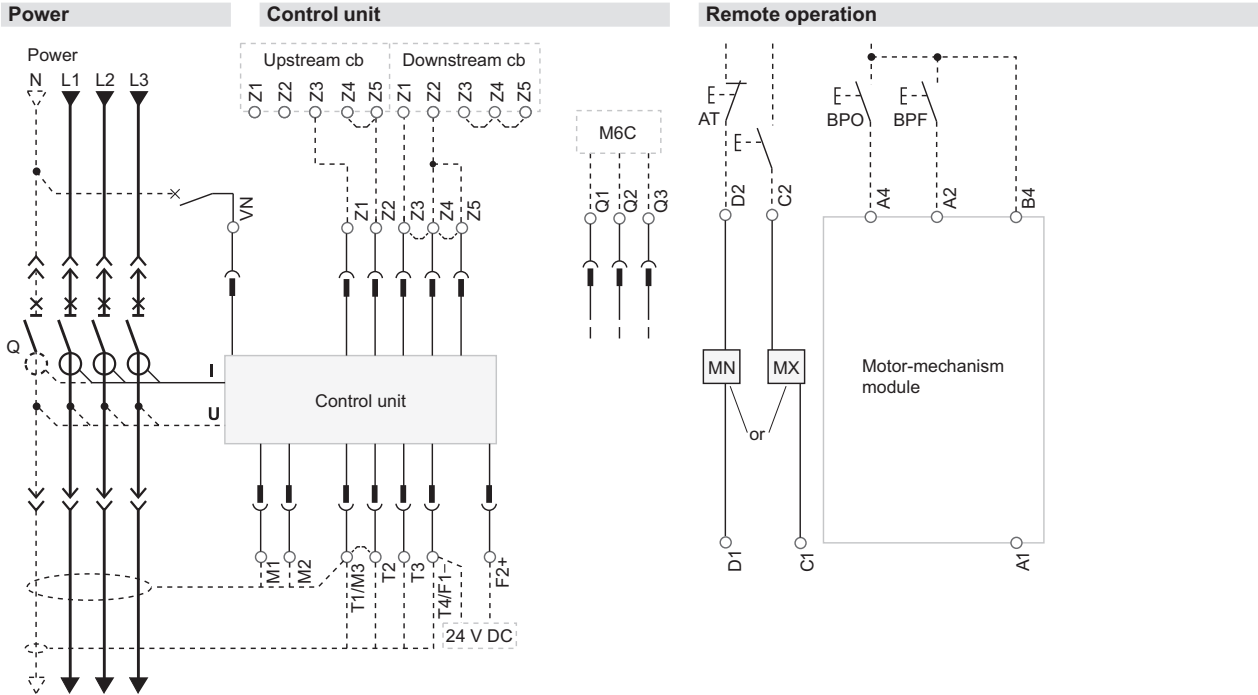

Basic	A	E	P	Control unit
■	■	■	■	E1-E6 communication
	■	■	■	Z1-Z5 zone selective interlocking: Z1 = ZSI OUT SOURCE Z2 = ZSI OUT ; Z3 = ZSI IN SOURCE Z4 = ZSI IN ST (short time) Z5 = ZSI IN GF (earth fault)
	■	■	■	M1 = Vigi module input (Control unit 7)
	■	■	■	T1, T2, T3, T4 = external neutral; M2, M3 = Vigi module input (Control unit 7)
	■	■	■	F2+, F1- external 24 V DC power supply
		■	■	VN external voltage connector (must be connected to the neutral with a 3P circuit breaker)
			■	M6C : 6 programmable contacts (to be connected to the external module M6C) ext. 24 V DC power supply required

E : energy
A : digital ammeter.
P : A + power meter + additional protection.

Remote operation

MN : undervoltage release
or
MX : shunt release

Motor-mechanism module (*)

A4 : electrical opening order
A2 : electrical closing order
B4, A1 : power supply for control devices and gear motor

(*) **Spring-charging motor 440/480 V AC**
(380 V motor + additional resistor)

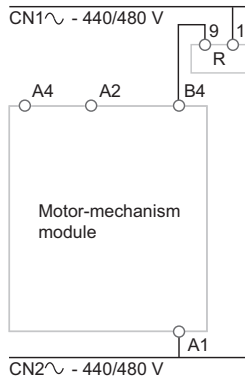

Molded Case Circuit Breakers BX series (800AF to 1600AF) Electrical diagrams

Indication contacts

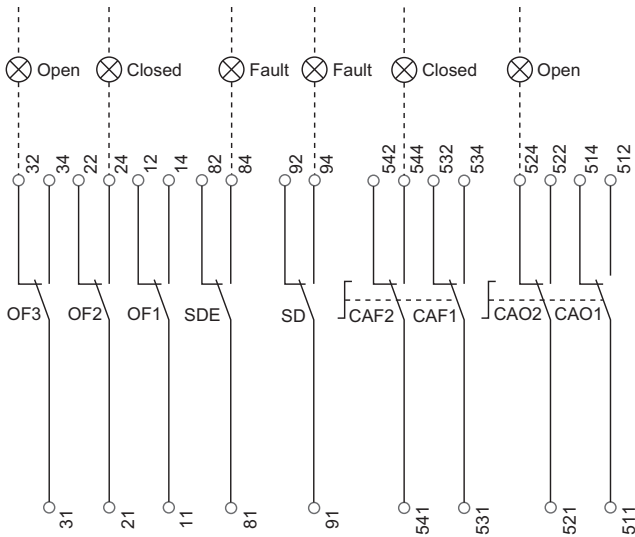

Terminal-block marking (manual operation)

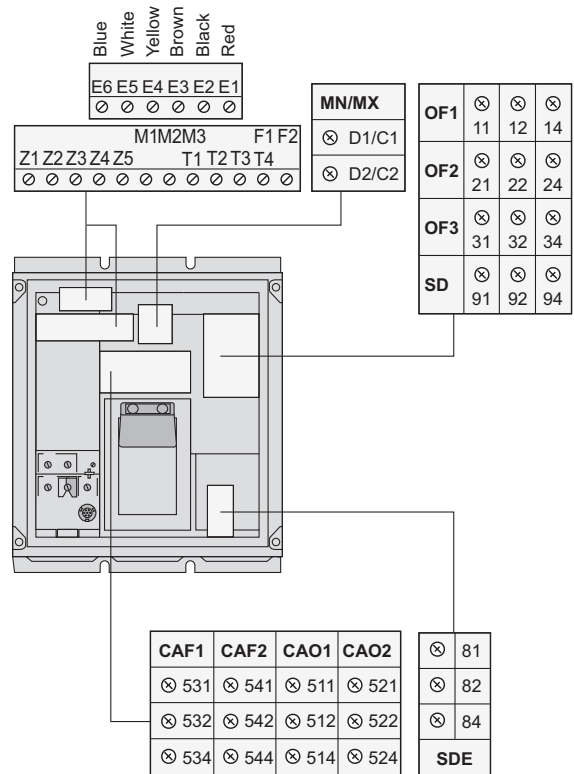

Indication contacts

- OF3 / OF2 / OF1** : indication contacts
- SDE** : fault-trip indication contact (short-circuit, overload, earth fault)
- SD** : trip indication contact (manual operation)
- CAF2/CAF1 *** : early-make contact (rotary handle)
- CAO2 / CAO1** : early-break contact (rotary handle)

Terminal-block marking (electrical operation)

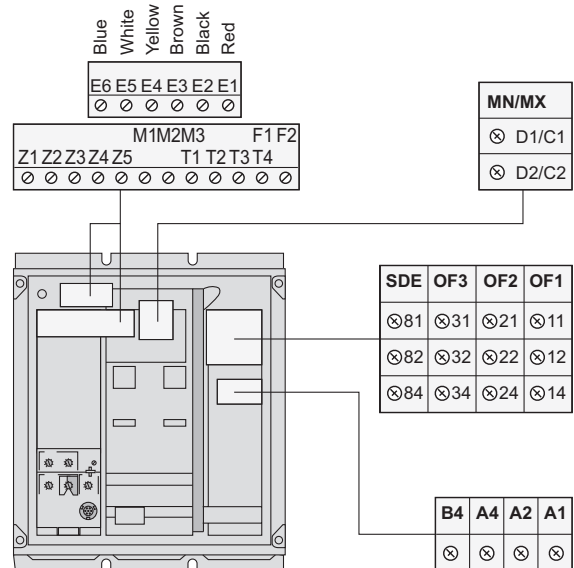

* CAF2 option is not compatible with M6C option.

Molded Case Circuit Breakers BX series (800AF to 1600AF) Electrical diagrams

■ BX800 to 1600 Plug-in circuit breakers

The diagram is shown with circuits de-energised, all devices open, connected and charged and relays in the normal position.

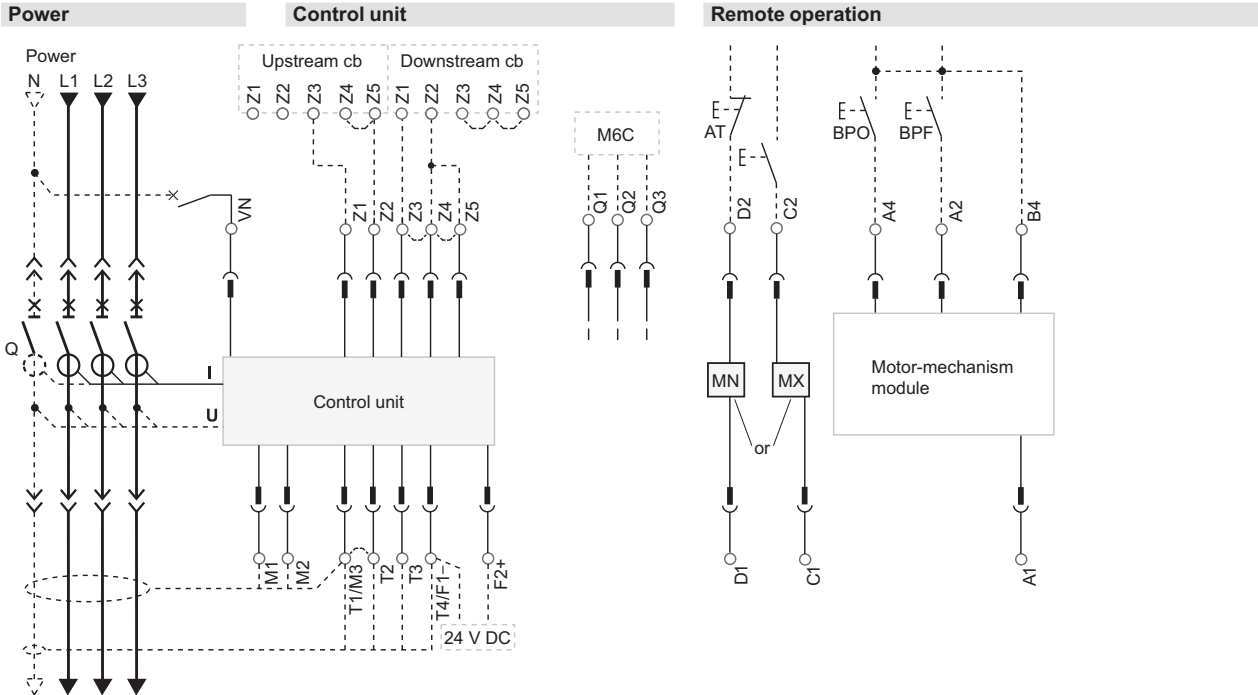

Terminal-block marking	Control unit					
	Com	UC1	UC2	UC3	M6C / CAF2	
	○ ○	○ ○	○ ○	○ ○	○ ○	○ ○
	E5 E6	Z5 M1	M2 M3	F2+	Q3	544
	○ ○	○ ○	○ ○	○ ○	○ ○	○ ○
	E3 E4	Z3 Z4	T3 T4	VN	Q2	542
	○ ○	○ ○	○ ○	○ ○	○ ○	○ ○
	E1 E2	Z1 Z2	T1 T2	F1-	Q1	541

Basic	A	E	P	Control unit
■	■	■	■	Com: E1-E6 communication
		■	■	UC1: Z1-Z5 zone selective interlocking: Z1 = ZSI OUT SOURCE Z2 = ZSI OUT; Z3 ZSI IN SOURCE Z4 = ZSI IN ST (short time) Z5 = ZSI IN GF (earth fault)
		■	■	M1 = Vigi module input (Control unit 7)
		■	■	UC2: T1, T2, T3, T4 = external neutral; M2, M3 = Vigi module input (Control unit 7)
		■	■	UC3: F2+, F1- external 24 V DC power supply VN external voltage connector (must be connected to the neutral with a 3P circuit breaker)
			■	M6C: 6 programmable contacts (to be connected to the external module M6C) ext. 24 V DC power supply required

A : digital ammeter.
P : A + power meter + additional protection.

Remote operation			
MN / MX	MT2	MT1	
○ ○ / ○ ○	○ ○	○ ○	
D2 / C2	A4	A2	
		B4	
		A1	
○ ○ / ○ ○			
D1 / C1			

Remote operation
MN : undervoltage release
or
MX : shunt release
Motor-mechanism module (*)
MT2 : **A4** : electrical opening order
MT1 : **A2** : electrical closing order
B4, A1 : power supply for control devices and gear motor (MCH)

(*) Spring-charging motor 440/480 V AC (380 V motor + additional resistor)

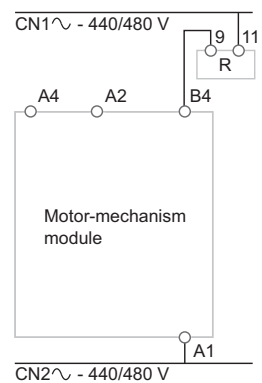

Molded Case Circuit Breakers BX series (800AF to 1600AF) Electrical diagrams

Indication contacts

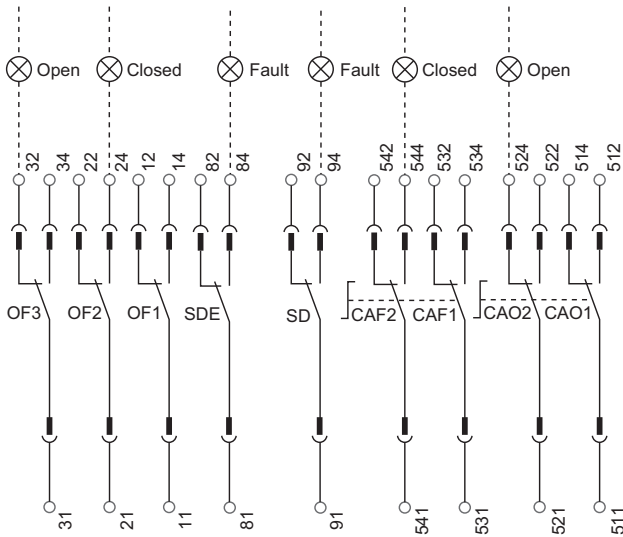

Carriage switches

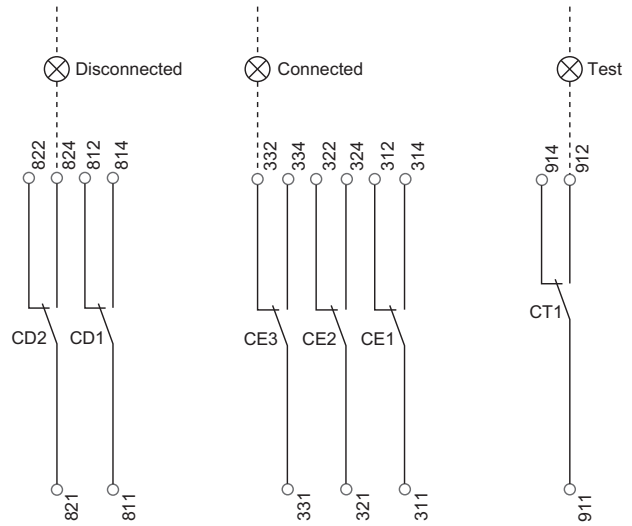

Indication contacts

M6C / CAF2	CAF1	SDE	SD	CAO2	CAO1	OF3	OF2	OF1	
Q3	544	534	84	94	524	514	34	24	14
Q2	542	532	82	92	522	512	32	22	12
Q1	541	531	81	91	521	511	31	21	11

Carriage switches

CD2	CD1	CE3	CE2	CE1	CT1
824	814	334	324	314	914
822	812	332	322	312	912
821	811	331	321	311	911

Indication contacts

- OF3 / OF2 / OF1** : indication contacts
- SDE** : fault-trip indication contact (short-circuit, overload, earth fault)
- SD** : trip indication contact (manual operation)
- CAF2/CAF1 *** : early-make contact (rotary handle)
- CAO2 / CAO1** : early-break contact (rotary handle)

Carriage switches

- CD2** : disconnected position
- CD1** : position
- CE3** : connected position
- CE2** : position
- CE1** : position
- CT1** : test position

Legend

Connected (only one wire per connection point).

* CAF2 option is not compatible with M6C option.

Molded Case Circuit Breakers BX series (800AF to 1600AF) Electrical diagrams

■ BX800 to 1600 Earth-fault and earth-leakage protection, Neutral protection, Zone selective interlocking

• External sensor (CT) for residual earth-fault protection

Connection of current-transformer secondary circuit for external neutral

Compact equipped with a control unit 6 A/E/P:

- shielded cable with 2 twisted pairs
- T1 twisted with T2
- maximum length 4 meters
- cable cross-sectional area 0.4 to 1.5 mm²
- recommended cable: Belden 9552 or equivalent.

For proper wiring of neutral CT, refer to instruction Bulletin 48041-082-03 shipped with it.

Do not remove control unit factory-installed jumper between T1 and T2 unless neutral CT is connected.

If supply is via the top, follow the schematics.

If supply is via the bottom, control wiring is identical; for the power wiring, H1 is connected to the source side, H2 to the load side.

For four-pole versions, for residual earth-fault protection, the current transformer for the external neutral is not necessary. Connection for signal VN is required only for power measurements (3 Ø, 4 wires, 4CTs).

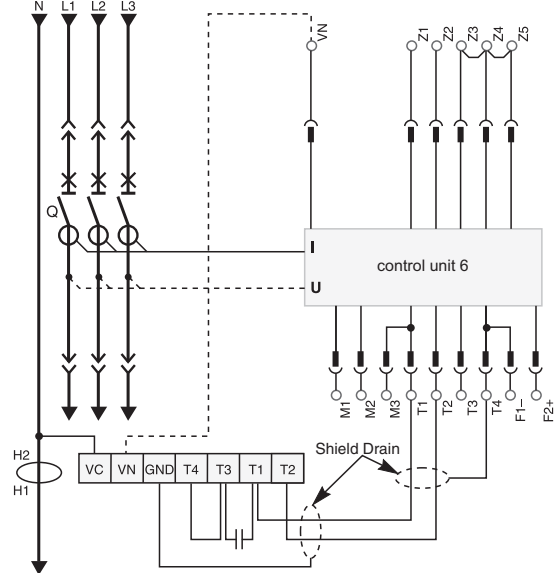

• External transformer for source ground return (SGR) earth-fault protection

Connection of the secondary circuit

Compact equipped with a control unit 6 A/E/P:

- unshielded cable with 1 twisted pair
- maximum length 150 metres
- cable cross-sectional area 0.4 to 1.5 mm²
- recommended cable: Belden 9409 or equivalent.

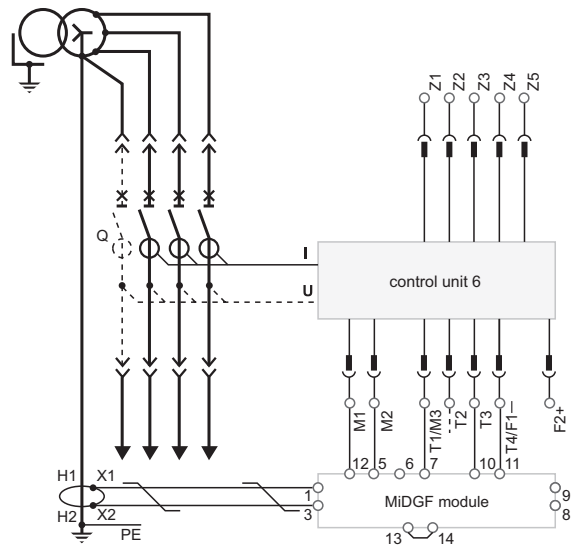

• Earth-leakage protection

Connection of the rectangular-sensor secondary circuit

Compact equipped with a control unit 7 A/P:
use the cable shipped with the rectangular sensor.

• Neutral protection

■ three pole circuit breaker:

- neutral protection is impossible with control unit A
- with control unit E/P, an external neutral transformer is necessary; the connection diagram is the same as for residual earth-fault protection.

■ four pole circuit breaker:

- BX equipped with control unit A
- the current transformer for external neutral is not necessary.

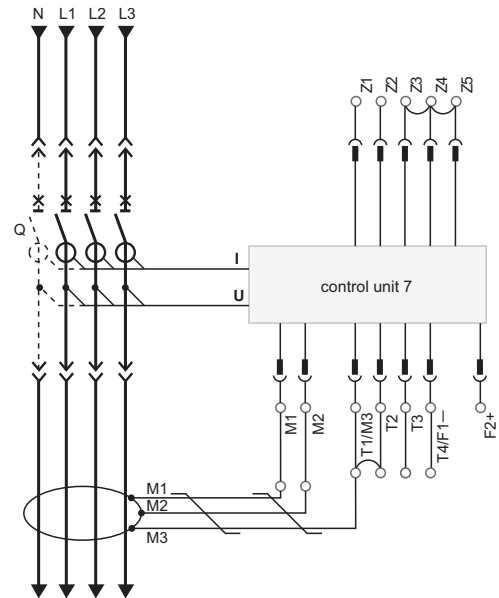

• Zone selective interlocking

Zone-selective interlocking is used to reduce the electrodynamic forces exerted on the installation by shortening the time required to clear faults, while maintaining time discrimination between the various devices. A pilot wire interconnects a number of circuit breakers equipped with A/E/P control units, as illustrated in the diagram above.

The control unit detecting a fault sends a signal upstream and checks for a signal arriving from downstream. If there is a signal from downstream, the circuit breaker remains closed for the full duration of its tripping delay. If there is no signal from downstream, the circuit breaker opens immediately, regardless of the tripping-delay setting.

Fault 1.

Only circuit breaker A detects the fault. Because it receives no signal from downstream, it immediately opens in spite of its tripping delay set to 0.3.

Fault 2.

Circuit breakers A and B detect the fault. Circuit breaker A receives a signal from B and remains closed for the full duration of its tripping delay set to 0.3. Circuit breaker B does not receive a signal from downstream and opens immediately, in spite of its tripping delay set to 0.2.

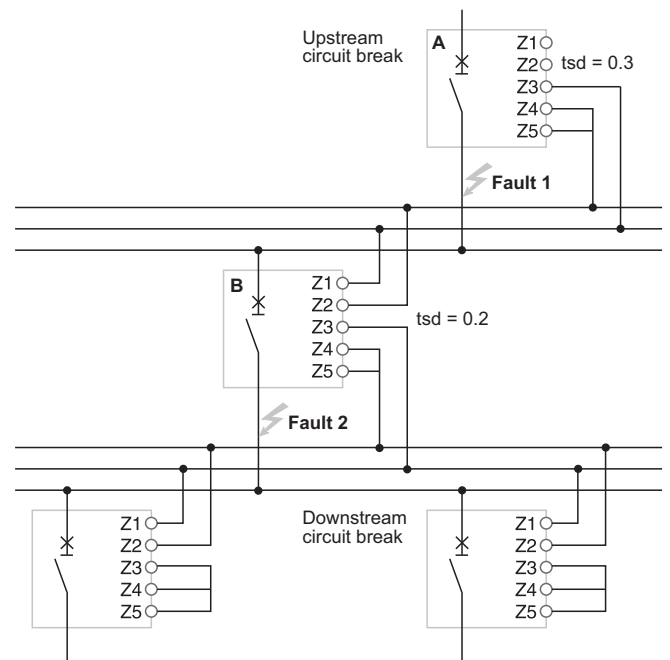

Wiring

- Maximum impedance: 2.7 W / 300 m.
- Capacity of connectors: 0.4 to 2.5 mm².
- Wires: single or multicore.
- Maximum length: 3000 m.
- Limits to device interconnection:
 - the common ZSI - OUT (Z1) and the output ZSI - OUT (Z2) can be connected to a maximum of 10 upstream device
 - a maximum of 100 downstream devices may be connected to the common ZSI - IN (Z3) and to an input ZSI - IN CR (Z4) or GF (Z5).

Molded Case Circuit Breakers BX series (800AF to 1600AF) Electrical diagrams

■ BX800 to 1600 Communication

• Connection of circuit breakers to the Modbus communication network

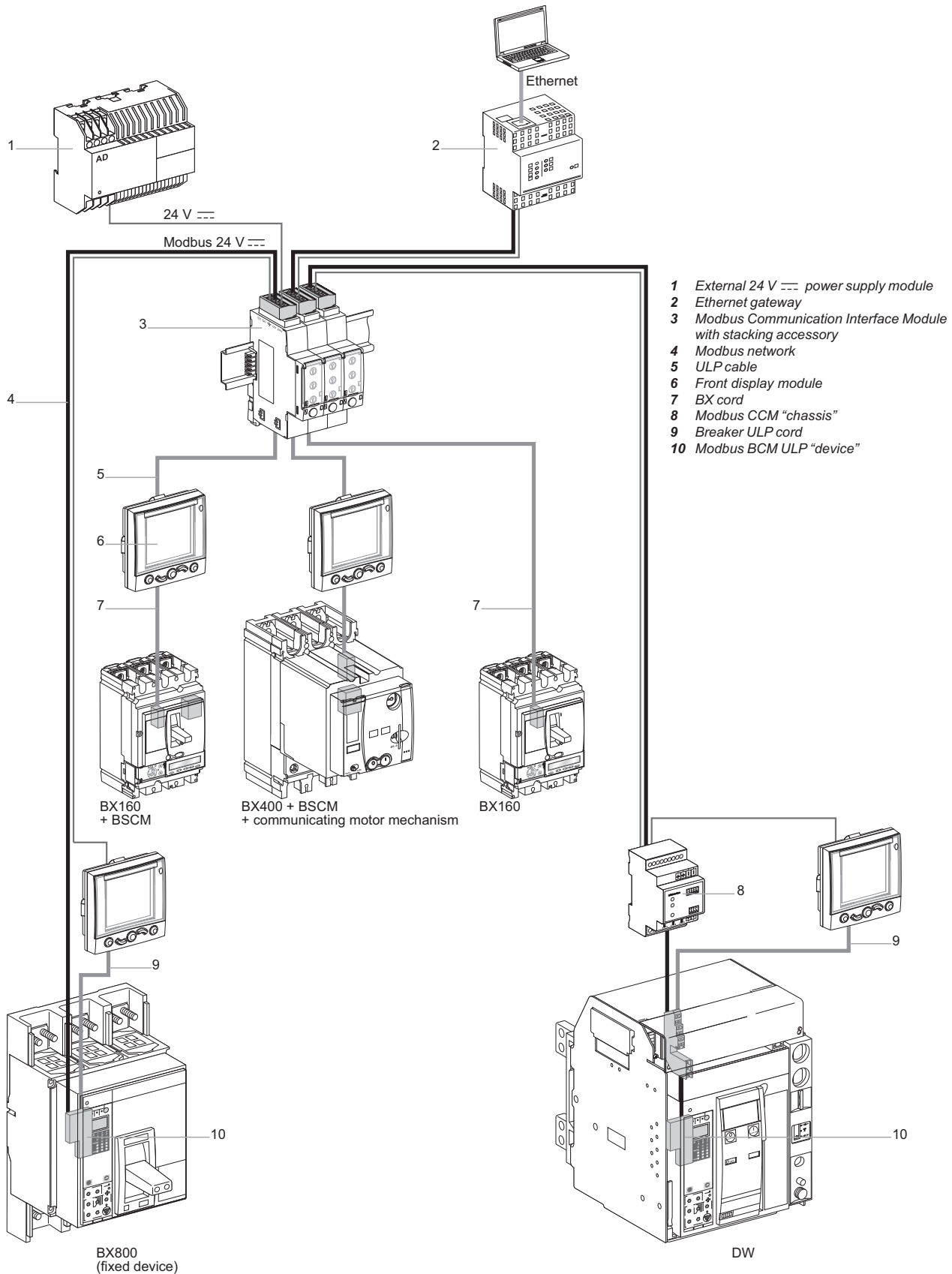

Molded Case Circuit Breakers BX series (800AF to 1600AF) Electrical diagrams

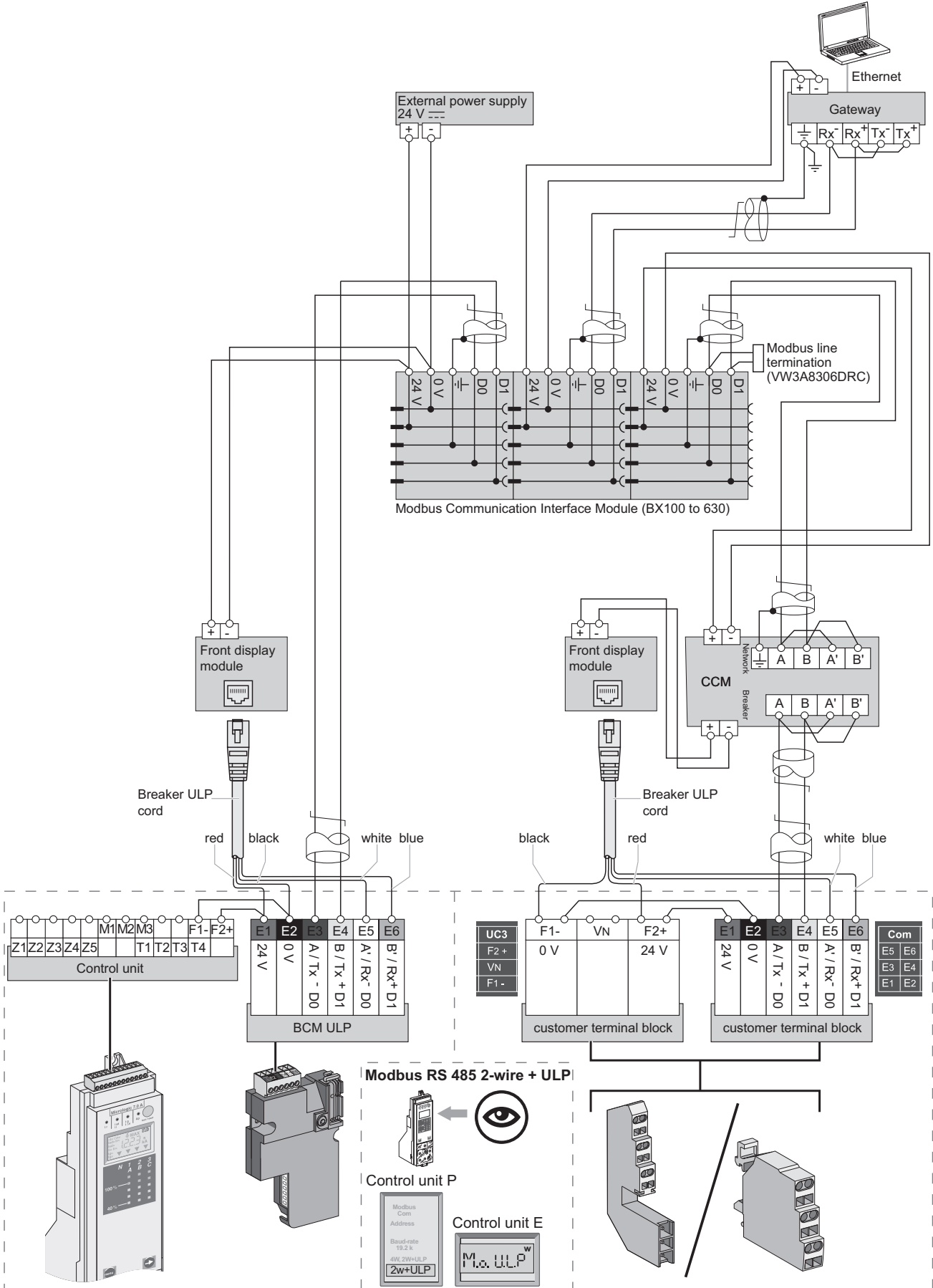

Molded Case Circuit Breakers BX series (800AF to 1600AF) Electrical diagrams

■ BX800 to 1600 fixed Wiring of the COM option (Modbus BCM ULP Module) with or without ULP module

• Fixed, manually operated BX

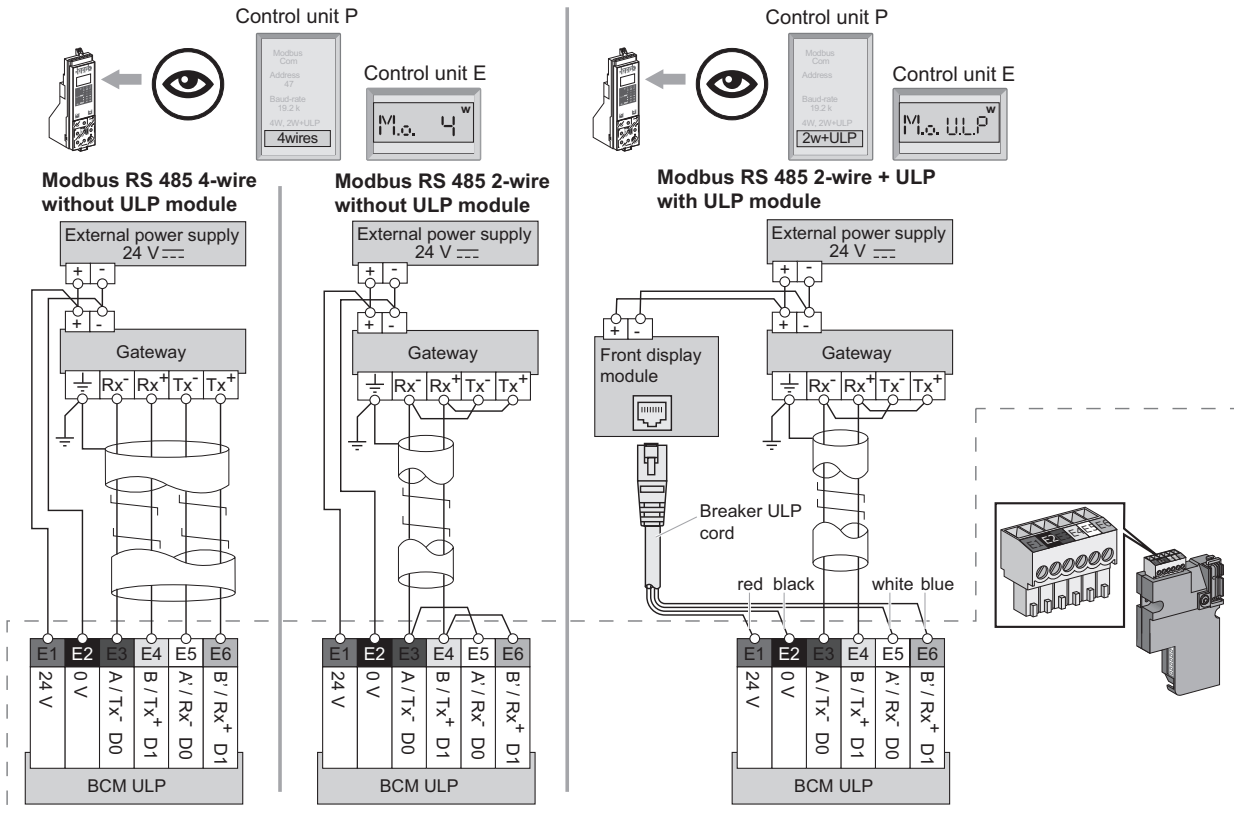

• Fixed, electrically operated BX

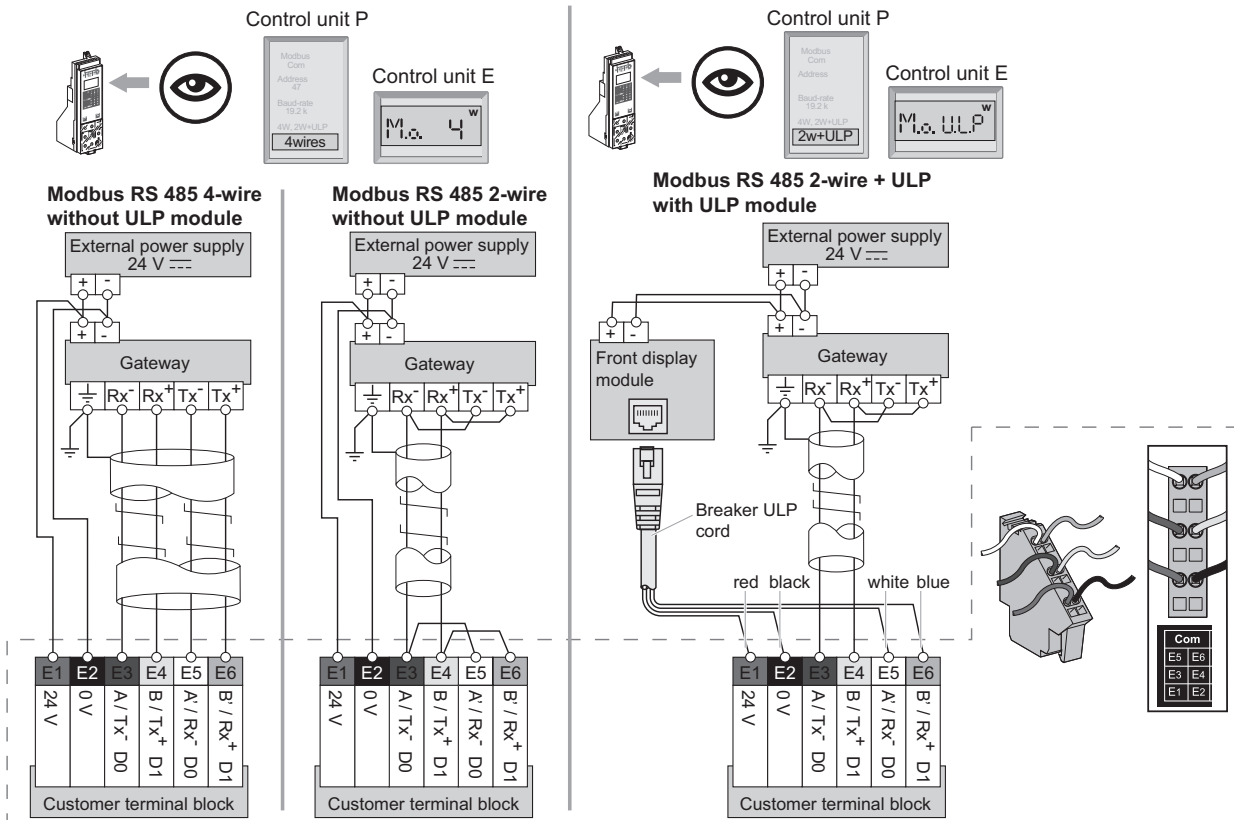

- The 24 V DC external power-supply (AD module) for the Control unit (F1- F2+) is not required for basic protections LSIG.
- The 24 V DC external power-supply (AD module) for the BCM ULP communication module (E1-E2) is required.
- The 24 V DC external power-supply (AD module) for the FDM121 front display module (0V +24) is required.
- The 24 V DC external power-supply (AD module) for the programmable contact M2C/M6C is required.
- The same 24 V DC external power-supply (AD module) can be connected to control unit, BCM ULP and FDM121, M2C/M6C.
- If voltage > 480 V AC or in an environment with a high level of electromagnetic disturbances, use separate power supply: 1 power supply for control unit (F1- F2+) and M2C/M6C, another power supply for BCM ULP and FDM121.
- With control unit A/E, it is recommended to connect 24 V DC external power-supply (AD module) to the control unit (F1- F2+) in order to keep available the display and the energy metering, even if Current < 20 % In.

Note: In case of using the 24 V DC external power supply (AD module), maximum cable length between 24 V DC (G1, G2) and the control unit (F1-, F2+) must not exceed 10 meters. The BAT battery module, mounted in series upstream of the AD module, ensures an uninterrupted supply of power if the AD module power supply fails. The internal voltage taps are connected to the bottom side of the circuit breaker.

With control unit P/H, external voltage taps are possible using the PTE option. With this option, the internal voltage taps are disconnected and the voltage taps are connected to terminals VN, V1, V2, V3. The PTE option is required for voltages less than 220 V and greater than 690 V (in which case a voltage transformer is compulsory). For three-pole devices, the system is supplied with terminal VN connected only to the control unit (control unit P).

When the PTE option is implemented, the voltage measurement input must be protected against short-circuits. Installed as close as possible to the busbars, this protection function is ensured by a P25M circuit breaker (1 A rating) with an auxiliary contact (cat. no. 21104 and 21117).

This voltage measurement input is reserved exclusively for the control unit and must not ever be used to supply other circuits outside the switchboard.

■ Connection

The maximum length for each conductor supplying power to the trip unit or M6C module is 10 m.

Do not ground F2+, F1-, or power supply output:

- the positive terminal (F2+) on the trip unit must not be connected to earth ground
- the negative terminal (F1-) on the trip unit must not be connected to earth ground
- the output terminals (- and +) of the 24 V DC power supply must not be grounded.

Reduce electromagnetic interference:

- the input and output wires of the 24 V DC power supply must be physically separated as much as possible
- if the 24 V DC power supply wires cross power cables, they must cross perpendicularly. If this is not physically possible, the power supply conductors must be twisted together
- Power supply conductors must be cut to length. Do not loop excess conductor.

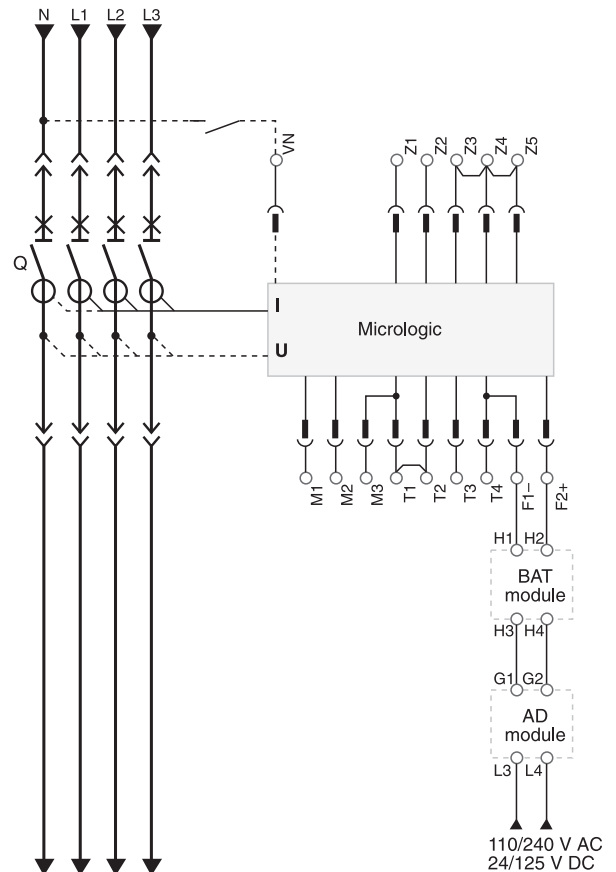

Molded Case Circuit Breakers BX series (800AF to 1600AF) Tripping curves

■ Tripping curves

• Electronic control units

Control unit 2.0

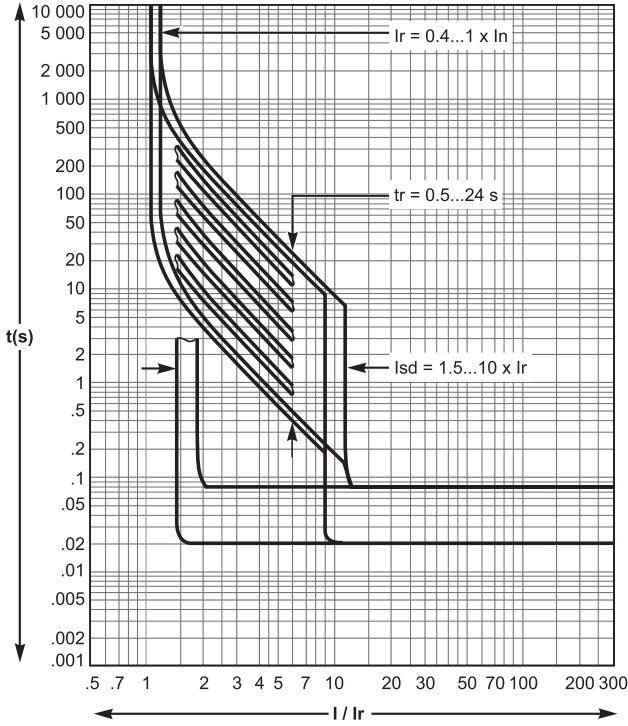

Control unit 5.0, 6.0, 7.0

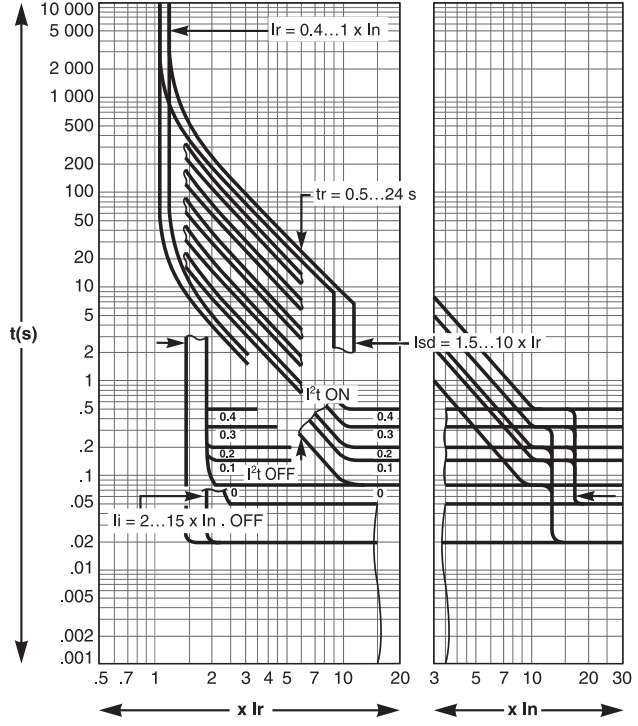

• Options for electronic control units

Earth-fault protection (Control unit 6.0)

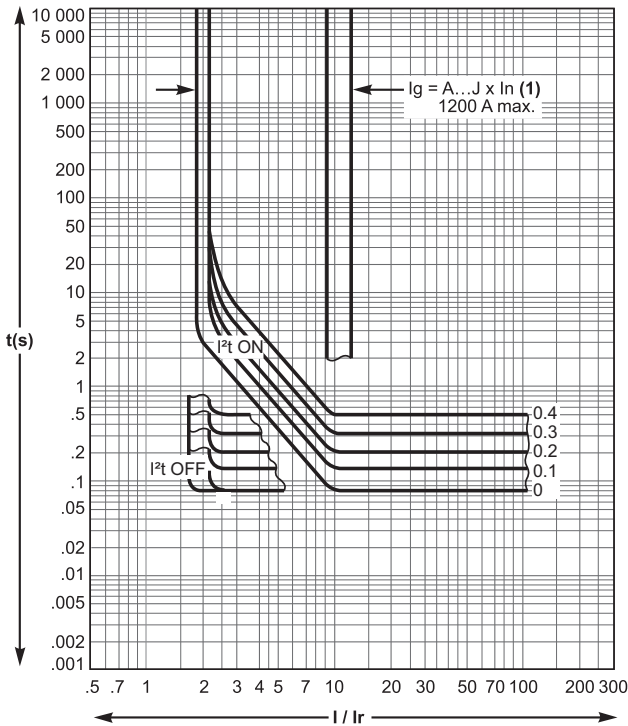

(1)

$I_g = I_n \times \dots$	A	B	C	D	E	F	G	H	J
$I_n < 400 \text{ A}$	0.3	0.3	0.4	0.5	0.6	0.7	0.8	0.9	1
$400 \text{ A} \leq I_n \leq 1200 \text{ A}$	0.2	0.3	0.4	0.5	0.6	0.7	0.8	0.9	1
$I_n > 1200 \text{ A}$	500	640	720	800	880	960	1040	1120	1200

Molded Case Circuit Breakers BX series (800AF to 1600AF) Tripping curves

■ $I_{cs} = 100\% I_{cu}$

The exceptional limiting capacity of the BX range greatly reduces the forces created by fault currents in devices.

The result is a major increase in breaking performance. In particular, the service breaking capacity I_{cs} is equal to 100 % of I_{cu} .

The I_{cs} value, defined by IEC standard 60947-2, is guaranteed by tests comprising the following operations:

- break three times consecutively a fault current equal to 100 % of I_{cu}
- check that the device continues to function normally:
 - it conducts the rated current without abnormal temperature rise
 - protection functions perform within the limits specified by the standard
 - suitability for isolation is not impaired.

■ Longer service life of electrical installations

Current-limiting circuit breakers greatly reduce the negative effects of short-circuits on installations.

Thermal effects

Less temperature rise in conductors, therefore longer service life for cables.

Mechanical effects

Reduced electrodynamic forces, therefore less risk of electrical contacts or busbars being deformed or broken.

Electromagnetic effects

Less disturbances for measuring devices located near electrical circuits.

■ Economy by means of cascading

Cascading is a technique directly derived from current limiting. Circuit breakers with breaking capacities less than the prospective short-circuit current may be installed downstream of a limiting circuit breaker. The breaking capacity is reinforced by the limiting capacity of the upstream device.

It follows that substantial savings can be made on downstream equipment and enclosures.

■ Current-limiting curves

The current-limiting capacity of a circuit breaker is expressed by two curves which are a function of the prospective short-circuit current (the current which would flow if no protection devices were installed):

the actual peak current (limited current),

thermal stress (A^2s), i.e. the energy dissipated by the short-circuit in a conductor with a resistance of 1Ω .

The limiting capacity of a circuit breaker is its aptitude to limit short-circuit currents.

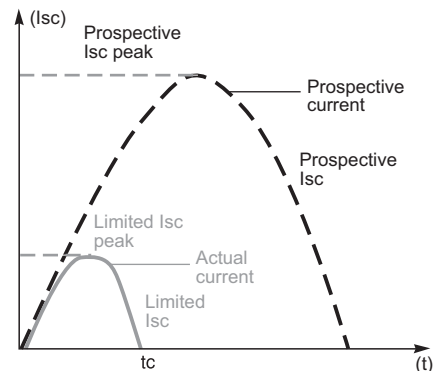

The exceptional limiting capacity is due to the rotating double-break technique (very rapid natural repulsion of contacts and the appearance of two arc voltages in-series with a very steep wave front).

Molded Case Circuit Breakers BX series (800AF to 1600AF) Current-limiting curves

Current-limiting curves

Current-limiting curves

Voltage 400/440 V AC ⁽¹⁾

Limited short-circuit current (kA peak)

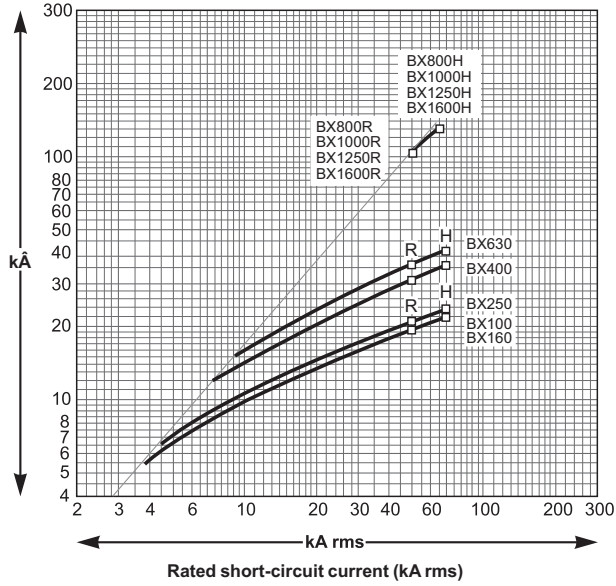

Voltage 660/690 V AC

Limited short-circuit current (kA peak)

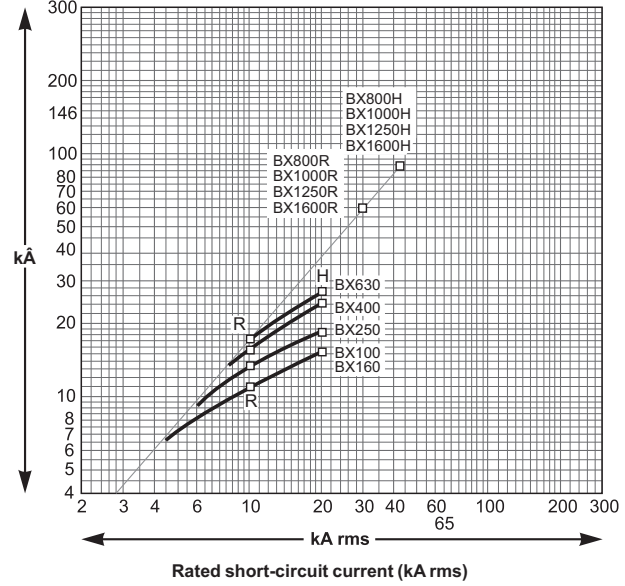

Thermal-stress curves

Voltage 400/440 V AC ⁽¹⁾

Limited energy

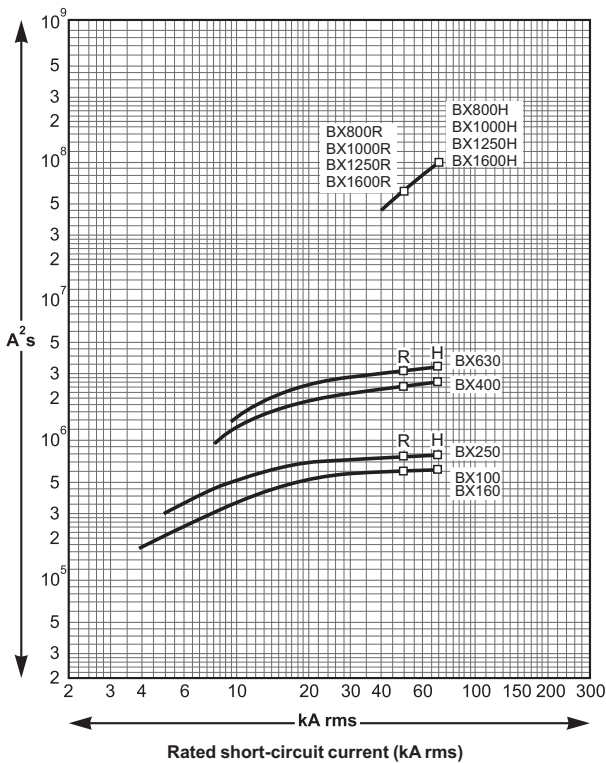

Voltage 660/690 V AC

Limited energy

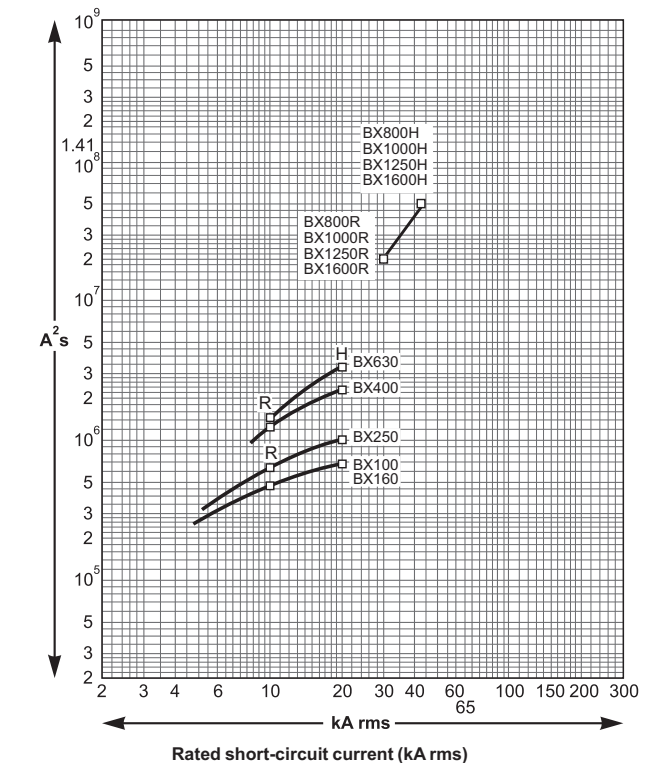

(1) Valid for 480 V Nema.

Molded Case Circuit Breakers

BX series

Ordering information

■ Ordering information

BX 250 RA E - 3P 250 □ H W K FA □ MA
 ① ② ③ ④ ⑤ ⑥ ⑦ ⑧ ⑨ ⑩ ⑪ ⑫ ⑬

①	Code	Basic type
	BX	BX Series MCCB

②	Code	Frame size
	100	100AF
	160	160AF
	250	250AF
	400	400AF
	630	630AF
	800	800AF
	1000	1000AF
	1250	1250AF
	1600	1600AF

③	Code	Breaking capacity range
	RA	415VAC/ Icu 50kA type
	HA	415VAC/ Icu 70kA type

④	Code	Usage
	E	Electronic
	G	Thermal-magnetic

⑤	Code	Pole
	3P	3P
	4P	4P

⑥	Code	Rated current
	016	16A
	025	25A
	032	32A
	040	40A
	050	50A
	063	63A
	080	80A
	100	100A
	125	125A
	160	160A
	200	200A
	250	250A
	400	400A
	630	630A
	800	800A
	10X	1000A
	12X	1250A
	16X	1600A

⑦	Code	Trip unit
	Blank	Thermal-magnetic
	A	Electronic type 2
	B	Electronic, type 5
	C	Electronic, type 2A
	D	Electronic, type 5A
	E	Electronic, type 6A
	F	Electronic, type 7A
	G	Electronic, type 2E
	H	Electronic, type 5E
	I	Electronic, type 6E
	J	Electronic, type 5P
	K	Electronic, type 6P
	L	Electronic, type 7P

⑧	Code	Connection/Style of front connection
	Blank	Fixed
	H	Fixed(with terminal extensions)
	G	Fixed(with 70mm pitch spreaders - 400/630AF)
	P	Plug-in(only 100-630AF)
	X	Rear connection

⑨	Code	Auxiliary switch
	W	1pcs.
	V	2pcs.

⑩	Code	Alarm switch
	K	Alarm switch 1pcs.
	J	Fault-trip indicator 1pcs.
	8	SDx module 1pcs.

⑪	Code		Shunt trip device		Code		Under voltage release	
			BX100-630	BX800-1600	BX100-630	BX800-1600		
	F2	24VAC	-	-	R2	24VAC	-	-
	F3	48VAC	-	-	R3	48VAC	-	-
	F5	125VDC	-	-	R5	125VDC	-	-
	FA	110-130VAC	100-130VAC/DC	-	RA	110-130VAC	100-130VAC/DC	-
	FB	-	277VAC	-	-	-	-	-
	FC	-	12VDC	-	-	-	-	-
	FK	220-240VAC	200-250VAC/DC	-	RK	220-240VAC	200-250VAC/DC	-
	FP	380-415VAC(50Hz)/ 440-480VAC(60Hz)	380-480VAC	-	RP	380-415VAC(50Hz)/ 440-480VAC(60Hz)	380-480VAC	-
	FQ	525VAC(50Hz)/ 600VAC(60Hz)	-	-	RQ	525VAC(50Hz)/ 600VAC(60Hz)	-	-
	FR	24VDC	24-30VDC/24VAC	-	RR	24VDC	24-30VDC/24VAC	-
	FS	48VDC	48-60VDC/48VAC	-	RS	48VDC	48-60VDC/48VAC	-

⑫	Code	Communication accessory
	A	BSCM+0.35m NSX cord
	B	BSCM+1.3m NSX cord
	C	BSCM+3m NSX cord

⑬	Code	Motor mechanism
	MR	24-30VDC
	MS	48-60VDC
	M4	110-130VDC
	MA	110-130VAC
	MK	220-240VAC
	MP	380-415VAC(50Hz)/440-480VAC(60Hz)
	M3	48-60VAC

■ MEMO

 Fuji Electric FA Components & Systems Co., Ltd.

5-7, Nihonbashi Odemma-cho, Chuo-ku, Tokyo, 103-0011, Japan

URL <http://www.fujielectric.co.jp/fcs/eng>